

9320 Reference Controller Operating Manual

Genelec UNIO Platform



THIS PAGE IS INTENTIONALLY BLANK

Table of Contents

1	Introduction	6
2	UNIO Concept.....	7
2.1	Genelec Loudspeaker Manager Software	7
2.2	Smart Active Monitor Systems	7
2.3	Reference Controller.....	7
2.4	Aural ID Technology Integration	7
3	Package Contents.....	8
4	General Description	9
4.1	Reference Controller Benefits	9
4.1	Reference Controller Signal Processing.....	9
4.2	Intended Applications	10
4.2.1	Loudspeaker-Based Monitoring.....	10
4.2.2	Headphone Monitoring	11
5	Features in 9320A.....	12
5.1	Connectors	12
5.1	Controls	13
5.1.1	Powering Up and Down	13
5.1.2	Control Knob and Display.....	14
5.1.3	Physical Control Mapping to GLM	15
5.2	Menu Functions	16
5.3	INPUT key: Selecting an Audio Input	18
5.4	Output keys: Selecting Audio Output.....	19
5.5	Display Screen Saver and key LED brightness.....	20
6	Getting Connected	22
6.1	Computer	22
6.2	GLM Network.....	22
6.3	Audio connections in 9320A.....	23
6.4	Audio connections to Genelec SAM monitors	23
6.5	USB Audio	24
6.6	Using Aural ID Binaural Rendering.....	24

7	Examples of Use.....	26
7.1	Out of the Box.....	26
7.2	Stereo and 2.1 Interfacing with 9320A	26
7.3	Immersive Monitoring	27
8	Using with GLM software	28
8.1	9320 Firmware Update	28
8.1.1	How to know a firmware update is available	28
8.1.2	Preparations for the firmware update	28
8.1.3	Performing the firmware update	28
8.1.4	Verifying the firmware update	30
8.2	9320 Device Configuration in GLM.....	30
8.2.1	Common Settings Configuration.....	31
8.2.2	Headphone Settings Configuration.....	33
8.2.3	Input/Output Settings Configuration	33
8.2.4	9320 Settings Set as a Group Property.....	35
8.3	Headphone Output Calibration	35
8.3.1	Headphone Specific Data	35
8.3.2	Personal Calibration of Headphone Sound	35
8.3.3	Output level trim.....	36
8.4	Measurement Microphone Placement.....	36
8.5	Calibrating SAM monitors on GLM network	36
8.6	Level Alignment for Other Monitors	37
8.7	Optimizing Signal-to-Noise Ratio.....	37
8.7.1	Input Level Optimization	37
8.7.2	Analogue Audio	37
8.7.3	AES/EBU Audio	37
8.8	SPL Display and Sound Exposure Logging	37
8.8.1	Principles of Exposure Calculation	38
8.8.1	How 9320 obtains exposure	40
8.9	Measurement Microphone and SPL Weighting.....	41
9	Independent Use of 9320 Without GLM	43
10	Function Reference.....	44

10.1	MONO.....	44
10.2	DIFF.....	44
10.3	INVERT.....	44
10.4	MUTE.....	44
10.5	DIM.....	45
10.6	PRESET.....	45
10.7	BASS M.....	45
11	Operating Environment.....	46
11.1	Operating and Storage Environment.....	46
11.2	Technical data and graphs for 9320A.....	46
12	Notes.....	51
12.1	Maintenance.....	51
12.2	Safety Warnings.....	51
12.3	Symbols.....	51
12.4	Compliance to FCC Rules.....	51
13	Guarantee.....	52

1 Introduction

Congratulations and thank you for choosing Genelec!

Since 1978, Genelec has been guided by a single idea – to make perfect active monitors that deliver neutral and accurate sound in every kind of acoustical environment. In Genelec's quest for this ultimate goal, our unrivalled commitment to research and development has led us to continuously develop innovative driver technology, electronic circuitry, enclosure designs and more. Our design philosophy is based on sustainability and environmental values, where industrial design serves our products' acoustical performance.

Your Genelec product has been designed and manufactured with care in our factory, in Finland, using environmentally efficient solutions to give reliable operation over many years.

Please take the time to read this manual. Happy monitoring!

2 UNIO Concept

Genelec UNIO concept unifies the loudspeaker-based and headphone-based methods of monitoring to one reliable and precise workflow, enabling secure bridging from using loudspeaker-based monitoring to using headphone-based monitoring.

This manual describes the set-up, configuration, and use of the 9320 device while the **GLM User Manual** and **Aural ID Operating Manual** discuss the configuration of the loudspeaker- and headphone-based monitoring. Please consult all three manuals as you configure your UNIO system solution.

2.1 Genelec Loudspeaker Manager Software

In the area of loudspeaker-based monitoring, the Genelec Loudspeaker Manager (GLM) software with its integral AutoCal automatic system calibration and alignment function, creates an easy step to enhance the precision and accuracy of monitoring, by reducing any uncertainties related to the room acoustic and loudspeaker installation locations and distances.

2.2 Smart Active Monitor Systems

Genelec Smart Active Loudspeaker (SAM) systems provide a wide selection of output capacity levels, suiting for all room sizes and applications, to implement loudspeaker-based monitoring layouts. With GLM software, precise calibration and bass management alignment is automatic and fast. Understanding the system performance is supported by the extensive GRADE report on room acoustic performance presenting complete information of the uncalibrated and calibrated system performance.

2.3 Reference Controller

The 9320 is a key device in the UNIO concept thinking, unifying the use of both the loudspeaker based and headphone based monitoring technologies and enabling equal access to loudspeaker-based and headphone-based monitoring. 9320 integrated completely with GLM software and Aural ID software, to empower fully integrated and efficient monitoring setups for all applications.

2.4 Aural ID Technology Integration

In the area of headphone-based monitoring, the Genelec Aural ID technology enables you to access your personal way of directional hearing in the form of your own Head-Related Transfer Function (HRTF) and the use of this in the Aural ID Plug-In and Aural ID Stand-Alone processing methods, including head tracking to maintain the layout of virtual monitoring loudspeakers on your headphones to remain stationary in space as you move and rotate your head wearing the headphones. The Aural ID technology provides a reliable and precise methodology to personally calibrate the virtual audio monitoring setup for your specific headphones and your HRTF information, enabling headphone monitoring able to access details similar to those available in loudspeaker-based monitoring.

3 Package Contents

9320 Reference Controller product package is delivered with the following content:

- 9320 Reference Controller device
- USB cable with type C connectors on both ends and an adapter enabling connectivity to USB-A sockets in a computer
- Genelec factory-calibrated measurement microphone and microphone holder
- Quick Setup Guide with an electronic link to this Operating Manual PDF file

4 General Description

4.1 Reference Controller Benefits

The Genelec Reference Controller is a Smart Monitoring Device designed as a solution to integrating all key monitoring technologies. Genelec Reference Controller enables precise imaging and neutral sound reproduction in demanding monitoring applications in all control rooms as well as for headphone monitoring.

The Reference Controller offers

- Management of Genelec Smart Monitoring System (SAM™) from stereo to immersive
- Personal calibration and use of Genelec Aural ID Plug-In and Stand-Alone from stereo to immersive
- A physical user interface for the most important Genelec Loudspeaker Manager (GLM™) functions
- Easy management of alternative monitoring systems in one room
- Easy switching between loudspeaker-based monitoring and headphone-based monitoring
- Professional grade headphone monitoring output with personal headphone sound character calibration
- Measurement-grade calibration microphone is included for acoustical system calibration
- Continuous SPL monitoring
- Logging of daily sound exposure (noise dose) for hearing health preservation, for both loudspeakers and headphones
- Stereo USB audio soundcard output function for monitoring purposes
- Stereo analogue and AES/EBU monitoring outputs and stereo analogue and AES/EBU line level inputs for monitoring
- Automatic GLM AutoCal™ calibration for SAM monitoring systems (when using GLM software)
- Detailed GRADE acoustic analysis report on SAM monitoring systems (when using GLM software)
- Access to Genelec Aural ID technology to enable personal HRTF rendering for reliable immersive monitoring (when using Aural ID 2.0 or later)

4.1 Reference Controller Signal Processing

The system frequency response of 9320 extends from 0.2 Hz (-3 dB) and up to 45 kHz (-3 dB) on all outputs for complete delivery of the full recorded audio content. The AES digital audio input accepts a samples rate range 32–192 kHz and word lengths up to 24 bits. The highest USB audio interface sample rate is 192 kHz.

The possible signal flows in 9320 enable any audio input to be routed to any audio output. This enables very versatile patching of signals for monitoring using 9320A, and fluent mixing of analogue and digital audio pathways in demanding monitoring applications.

9320 supports seamless blending of loudspeaker-based monitoring with headphone-based monitoring, and integration of personal HRTF processing using Genelec Aural ID technology. 9320 integrates completely with Genelec GLM software for calibrating and managing Genelec SAM monitoring loudspeakers. There is complete support for all professional analogue and digital audio monitoring loudspeakers and headphones.

The maximum signal into the analogue line input can be set such that the total system dynamic range is optimized. There are two selections, for maximum input levels of +12 dBu (HiGain) and +24 dBu (LoGain). This feature is configured using the GLM software, as a part of all other 9320 configurations.

In the signal processing diagram the volume control is presented before the signal processing functions for sake of clarity. In reality, to maximize the dynamic range of the audio signal, volume control happens as the last signal processing function before the signal is output.

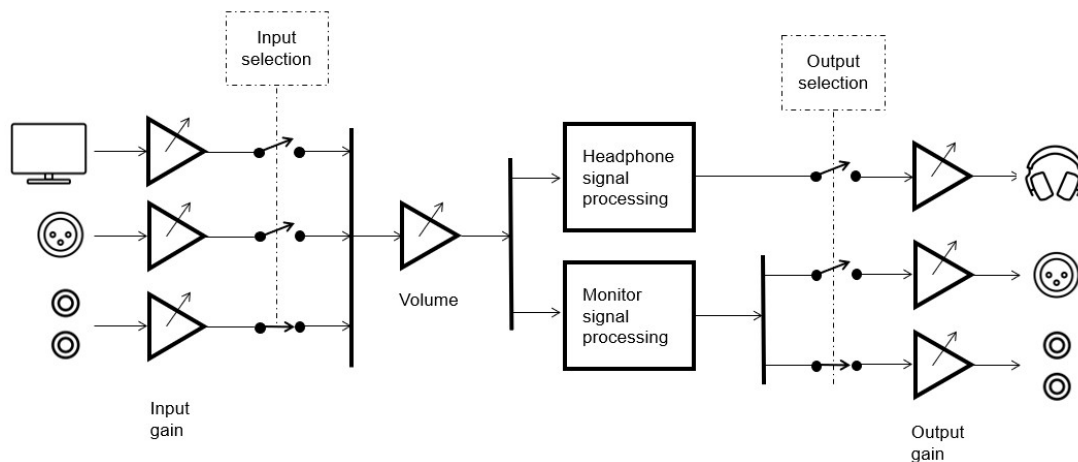

Fig. 1. Signal processing block diagram of 9320A.

4.2 Intended Applications

9320 is intended to be used with the GLM software and Aural ID software but can be also used in the Independent mode.

4.2.1 Loudspeaker-Based Monitoring

9320 Reference Controller is a physical user interface for the most important Genelec Loudspeaker Manager (GLM™) functions, empowering management of Genelec Smart Monitoring System (SAM™) from stereo to immersive and enabling easy management of alternative monitoring systems.

9320 offers direct connectivity to analogue and digital stereo or 2.1 monitoring of audio signals input using the USB soundcard function, analogue line input or AES digital audio input. The outputs can be level aligned for smooth switching across inputs and outputs. Genelec SAM monitoring systems can be automatically calibrated using the GLM AutoCal™ calibration and the included measurement microphone. This gives access also to the detailed GRADE acoustic analysis report on SAM monitoring

systems. Using the measurement microphone, continuous sound level monitoring is available with the SPL display, noise dose logging and hearing health alarms linked to the noise dose.

9320 Reference Controller supports compensation of the monitoring system output sensitivity, enabling smooth switching between all connected monitoring systems as well as switching to Genelec SAM monitoring systems controlled by 9320A.

4.2.2 Headphone Monitoring

In addition to the loudspeaker-based monitoring solutions, the 9320 offers a professional-grade headphone monitoring output, support for personal headphone sound character calibration and access to Genelec Aural ID technology enabling rendering of audio using a personal HRTF for reliable stereo and immersive channel layout monitoring with accuracy similar to using loudspeakers.

The headphone output is usually described using the headphone sensitivity or the headphone efficiency. The headphone sensitivity explains how high sound level is created with a known magnitude of electronic input, given as dB SPL per input voltage. The headphone efficiency is given as the sound level (dB SPL) generated with a given input electrical power. One of these figures is usually stated in the data sheet of a headphone and can be used to understand the maximum sound level a headphone can reach with 9320 headphone amplifier.

The headphone amplifier in 9320 supports professional headphones in the impedance range 16–600 ohm. The maximum output current to the headphone is 120 mA, and the maximum output voltage is 6 Vrms. The maximum output power to the headphone depends on the headphone impedance (see Table 1). At higher headphone impedances the maximum output power will reduce.

Table 1. Headphone output support range

Headphone output load condition	Headphone impedance (Ω)	Max output power (mW)
Max output power into two simultaneous output channels, both channels loaded	16	120
	32	140
	150	200
	300	115
	600	57

5 Features in 9320A

5.1 Connectors

On the back side, 9320 has (see Fig. 1, from left to right) the following connectors

- Genelec measurement microphone connector
- Headphone output, 6.3 mm stereo jack
- Two analogue balanced line outputs, 6.3 mm tip-ring-sleeve connectors
- Two analogue balanced line inputs, 6.3 mm tip-ring-sleeve connectors
- Digital audio output supports AES/EBU (AES3) format, XLR connector
- Digital audio input supports AES/EBU (AES3) format and S/PDIF format when used with an separate 75 to 110 ohm impedance converter, XLR connector
- GLM monitor loudspeaker management network interface (bottom connector) and GLM network terminator, optionally used when the management network is long (top connector)
- PWR is an auxiliary USB-C power input for use when the computer USB output cannot supply sufficient power for 9320A
- USB-C computer interface, used for management, audio input, and power supply for 9320A
- Kensington compatible anti-theft lock opening



Fig. 2. Back side connectors of 9320

5.1 Controls

The main elements of the 9320 user interface are monitor control function keys on the left side, monitor selection keys on the right side, control knob and display.

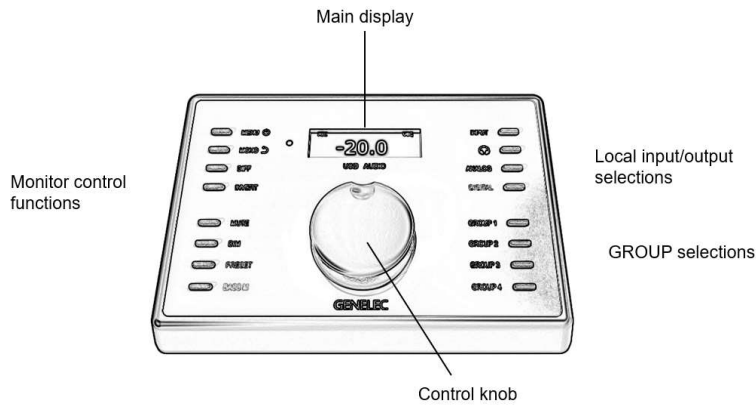

Fig. 3. Elements in the 9320 controller user interface.



Fig. 4. The 9320 controller user interface.

5.1.1 Powering Up and Down

The 9320 is powered up and down by pressing the MENU key.

To power the 9320 down, a long press on the MENU key is needed. When power down time-out count begins, the display shows the waiting time passing until 9320 powers down.

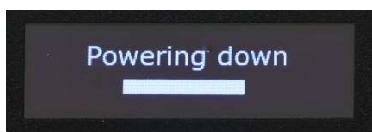

Fig. 5. The power-down counter display in 9320A.

If the MENU key is released before the power-down counter reaches zero, 9320 resumes normal operation. The power-down counter is shown to prevent unwanted or accidental powering down of 9320A. The 9320 can also be turned off by selecting the 'Power Down' in the MENU.

5.1.2 Control Knob and Display

The control knob with two main functions: volume control and volume control in GLM and selection and adjustment when using menu functions. The knob controls output level to the selected output and the GLM Smart Active System volume level. When the absolute SPL display is set in the GLM software, the volume value is shown as sound level at the listening position, in dB SPL scale. The display shows the current output level on SPL scale relative to the max SPL, or on absolute SPL at the listening location, available after calibration. The top row can contain small labels and these indicate the state of the 9320.



Fig. 6. Relative level display (left), absolute SPL level display (right).

Table 2. Top row display indications

Label	Meaning
GLM	GLM software is communicating with the 9320
MIC	Measurement microphone is connected to 9320A
CAL	n.a.
MEQ	Optional EQ (this option is not in use)
UEQ	User equalizer is set for the headphone output
SED	Sound Exposure Dose (noise dose caused by the audio signal)
AID	Aural ID is in use; this is communicated by the GLM software
Max level	When the "Max level" label is shown, the maximum SPL restriction has been set and is active

5.1.3 Physical Control Mapping to GLM

The 9320 controls match the controls in the GLM software user interface and local controls. Using 9320 can replace the use of GLM software, enabling GLM to run in the background in a digital audio workstation while having physical controls to access most essential GLM functions.



Fig. 7. The matching controls in the 9320 (left) GLM software (right).

GROUP keys are an effective and fast way of switching between Groups in the GLM software setup. A Group contains all the setup-related settings for the GLM and the SAM monitors that affect the room equalization, system alignment, level preset calibrations, and audio input selections, and are therefore a very efficient means of moving between different monitoring situations. The four GROUP keys located at the right side activate the first four Groups set up in the GLM software user interface. If less than four Groups have been set up in the GLM software, only the GROUP keys matching with actually existing Groups in GLM will select a group. For more information on how to set up and use Groups, please consult the GLM User Manual.

The GROUP key texts light up (white) when a group is defined in GLM software. If one or more of the four groups is not defined, the key text remains dark.



Fig. 8. The four GROUP keys select and activate (left) the first four Group settings in the GLM software user interface (right).

The GLM user interface software has a powerful set of system level management selections. In addition to controlling mute and dim functions, these can also offer access to calibrated monitoring level. The MUTE, DIM, PRESET and BASS M physical keys on 9320 are directly controlling the 'Mute All', 'Dim All', the first system preset level and 'Bass Man' settings in the GLM software user interface. In this way, 9320 offers a quick way of managing the complete monitoring playback.

The preset level is configured in GLM software, and the value is stored in the System Setup File.

The BASS M switch operates the bass management bypass system in GLM software. Bass management bypass prevents crossover filtering in a subwoofer and passes the full band signal to monitors instead of filtering and playing the low frequencies in the subwoofer.

The mute, dim, preset and bass management functions can be configured using the GLM software.

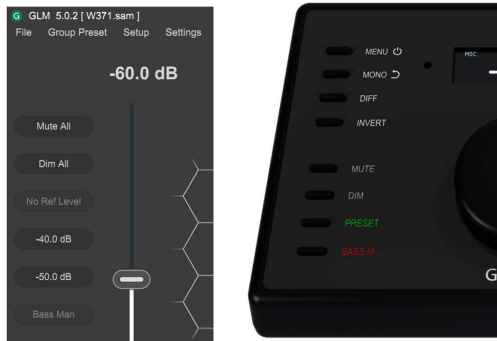

Fig. 9. The MUTE, DIM, PRESET and BASS M keys control the 'Mute All', 'Dim All', system preset level no 1 (top key) and 'Bass Man' keys in the GLM user interface software.

5.2 Menu Functions

Entry into the menu functions is done by pressing the MENU key. This brings the menu selection into the main display. A menu function can be selected by rotating the control knob. To adjust first rotate the knob for the right function, then enter the function by pressing the MENU key.

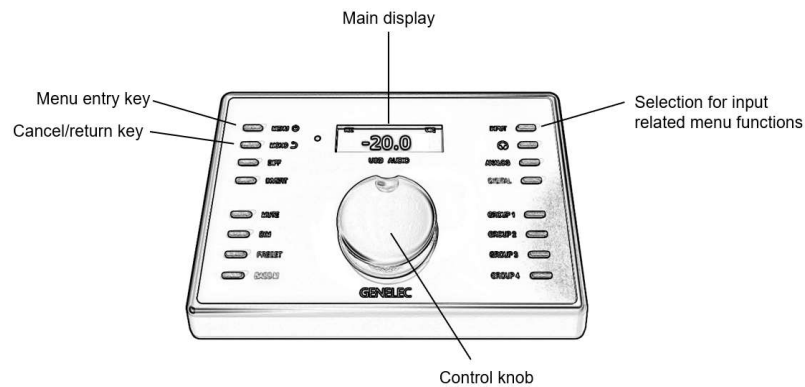

Fig. 10. Menu-related controls in 9320A.





Each function can contain several items. The items can be selected by rotating the control knob and then pressing MENU key to select an item. Once inside the item, the setting or value of the item can be seen; to adjust the values, use the GLM software.

At any time, it is possible to cancel the current menu selection or to back up to the top of the menu tree using the MONO key that also shows the reverse arrow icon.

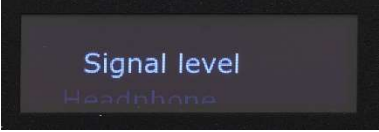
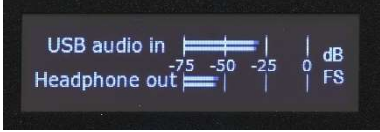

There is also a time-out exit from the menu function – 9320 exits the menu structure after a two-minute time-out.

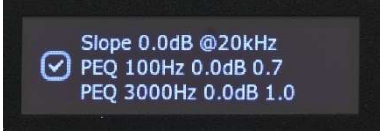
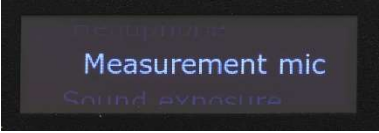
Table 3. Menu item descriptions.

Menu Display	Description
	<p>Signal level metering</p> <p>Pressing again the MENU key brings up the input and output level meters. The currently selected input and output are shown.</p>  <p>Pressing the MONO (return) key returns out of the menu item.</p>
	<p>Headphone menu contains a submenu with the following items</p> <p>User EQ</p> <p>Pressing MENU key enters the item and shows the currently set user equalizer UEQ filetr settings for the headphone output.</p>  <p>User EQ enabled or disabled is shown as the check mark or no check mark in the left side box.</p> <p>Cancel can be selected to reverse out of the menu.</p>
	<p>Measurement mic</p> <p>Shows the measurement microphone serial number and the selected weighting and SPL level. This serial number should match the serial number printed on the Genelec measurement microphone body.</p> 

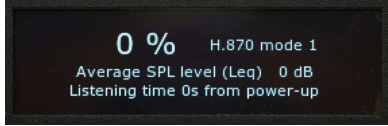
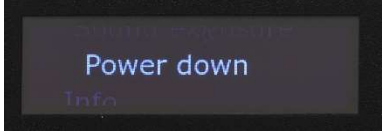
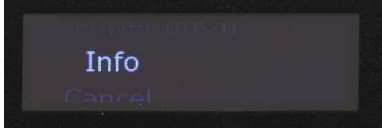
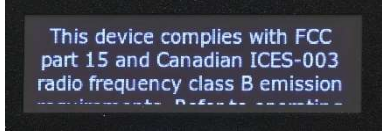
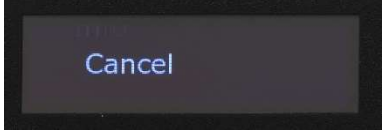
	<p>Sound exposure shows the sound exposure/noise dose level, the selected sound exposure standard used for metering, and the dose cumulation time.</p> 
	<p>Selecting the Power down runs the power down sequence of 9320A.</p>
	<p>Info shows the FCC declaration as a scrolling text.</p> 
	<p>Cancel backs out of the menu system to the main display.</p>

Note that the 9320 setup is done using the GLM software. Because of this, the 9320 settings are mostly not available in the device menu.

5.3 INPUT key: Selecting an Audio Input



Fig. 11. Selection for audio input in 9320A.

The audio input is selected using the INPUT key. At the first press, this brings up the currently selected input. Rotating the control knob allows the input to be changed. The new input selection becomes active with an additional press on the INPUT key. Steps to select an input are

- Press the INPUT key repeatedly to toggle through all the inputs
- When you leave a input selection in the display, this selection is applied after a time-out of about one second

If you do not want to select a new input, press the MONO key to select 'Cancel' before the selection time-out has passed. If you do not cancel, the currently displayed input gets selected.

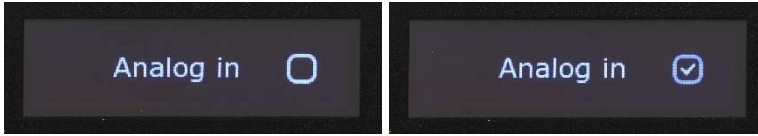

Fig. 12. Example of selecting the analogue input – click the ANALOG key on 9320A. The analog input shows in the display (left). After a short delay, the analog output gets selected (right) and turns on.



Fig. 13. The DIGITAL and USB audio input shown as selected and on.

5.4 Output keys: Selecting Audio Output

The audio output can be selected by pressing the keys for headphone, ANALOG and DIGITAL outputs.



Fig. 14. Selections for audio outputs in 9320A.

Select the output by pressing one of the following keys: headphone symbol, 'ANALOG,' or 'DIGITAL.' This shows the selected output in the display, the text next to the selected key turn on, and the selected output audio turns on.

The mode of level control is shown after the output name as "9320 level control" when the 9320 Reference Controller is adjusting the level of the outgoing audio signal level when the volume level is being adjusted.

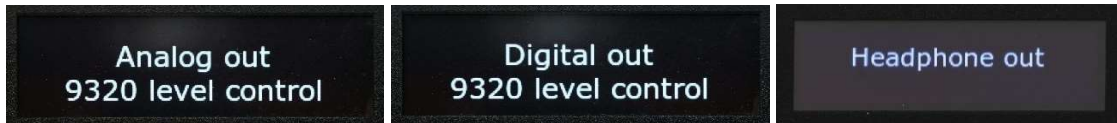

Fig. 15. The output level adjusted by 9320A

Pressing any output key longer than 3 sec turns all outputs in 9320 off. Then, the display shows the text “No output” and the second line “GLM level control”. After a brief time, the display returns to the main display, showing the current level setting but all the outputs in 9320 remain off. This mode can be useful for example 9320 is adjusting level on a set of SAM monitors particularly when the GLM software is not in use, and the 9320 works in stand-alone mode. This mode is indicated with the second line of text in display saying “GLM level control”.

Pressing any output selection key when the “GLM level control” mode is active returns the outputs in 9320 on.

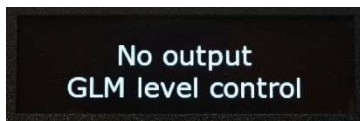

Fig. 16. The output of 9320 not in use, for example when 9320 is controlling an external set of SAM monitors receiving audio from an outboard audio interface.

The MUTE key mutes all outputs of 9320A, and outputs controlled by the GLM software, making the MUTE key a universal way of muting all audio controlled by 9320A.

5.5 Display Screen Saver and key LED brightness

When any control (knob, keys) on the 9320 is used, the display in 9320 automatically turns on. The 9320 detects the brightness in the room and adjust the brightness of the display and the key lighting automatically with the room illumination.

The screen saver turns the display off after a period of no access to the 9320 physical controls. The display screen saver activates in steps. If ot controls on the 9320 are used, the display brightness reduces first, and after some time, the display turns off.

This display screen saver is always active and cannot be disabled, but the screen saver activation time can be adjusted. The screen saver activation time can be adjusted using GLM software, in the 9320 setup, using the “Screen saver” setting. The time is given in seconds. Using a very long display screen saver time may reduce the display lifetime. The default time is one minute.

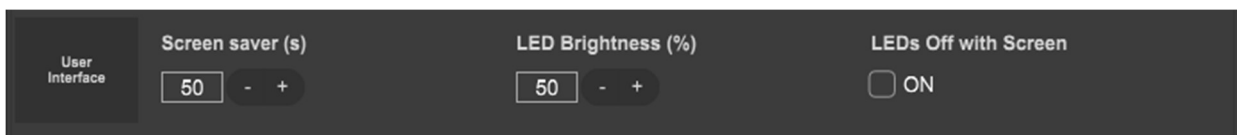

Fig. 17. User interface controls: screen saver activation delay, LED brightness and LED turn off with scree controls.

The “Led brightness (%)” setting controls the brightness of the lighting of the texts next to the keys on 9320A. Selecting the “LEDs Off with Screen” ON turns off the lighting at the keys when the display banks off. This can be useful when any lighting on the 9320 must be avoided to remove distraction by

the key lights. This is normally not selected, and then the key lights remain on even when the display screen saver turns on.

It is not possible to entirely disable the display display screen saver as this would significantly reduce the display life time. In order to maximize the display life time, it is useful to keep the screen saver time relatively short.

6 Getting Connected

6.1 Computer

The 9320 controller is powered by USB power and also interacts with the computer and receives USB audio over the Computer connector. Follow these steps to connect 9320 to a computer

- Connect computer USB output to 9320 controller using a USB type C to type C cable (included)
- When computer USB output is of type A, use a USB type C to type C cable with the type C to type A adapter (included) or a regular type A to type C cable.
- Optional power input is intended for a type C USB power supply. This input is needed if your computer is unable to supply power to 9320A, for example, with certain USB hubs. When 9320 is directly connected to a computer, this is normally not needed but can be used to reduce the total amount of power supplied by a computer.
- Install and run GLM software. All configuration of the 9320 is done using the GLM software, and using the GLM software for setup enables the full experience of 9320A. The GLM software is available at the Genelec web site www.genelec.com/glm
- See the GLM user manual for more information on the setup and configuration of the 9320A.
- When using Aural ID 2.0 or later, consult the Aural ID software user manual for more details on configuring the Aural ID with 9320A.

6.2 GLM Network

In order to use the setup in GLM software for Genelec Smart Active Monitor (SAM) loudspeakers, the GLM management network must be connected for setup from 9320 to all monitoring loudspeakers.

Follow these steps

- Starting at the GLM network connector in 9320A, connect a GLM network cable to link all monitors and subwoofers in a daisy-chain manner. Use CAT5 or CAT6 cables to the "CONTROL NETWORK" connectors of all the Genelec SAM monitors and RAM amplifiers. After starting at the 9320A, the order connection to monitors is not significant.
- When the total GLM network is very long, more than 300 meters, run the final network cable back from the last SAM monitor to the GLM network terminator connector in the 9320 (TERM).
- When the GLM network is complete, the correct number of devices (monitors, subwoofers and other audio processing devices) shown in the GLM software will match the actual number of devices.

Now creation of the (first) GLM system calibration and group settings can start.

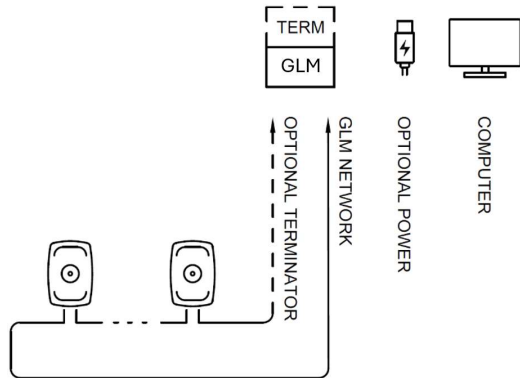

Fig. 18. Computer, optional power and GLM network connections.

6.3 Audio connections in 9320A

Audio output for stereo monitoring is directly supported by 9320A. There are three ways to input stereo audio signal to be monitored at any of the 9320 outputs.

- Stereo USB audio
- Stereo AES/EBU digital audio input (DIGITAL IN)
- Two analogue balanced line inputs (ANALOG IN)

The stereo audio output is available over balanced analogue lines outputs, over an AES/EBU output, or to the headphone output.

Any audio input can be routed to any of the monitoring outputs.

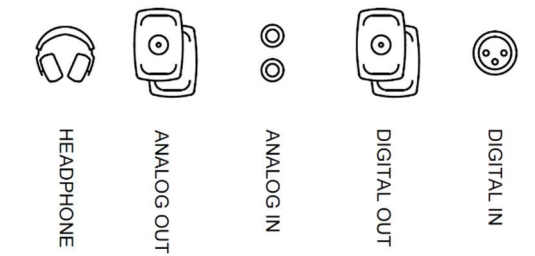

Fig. 19. Monitoring inputs and outputs in 9320A.

The audio input to 9320 is selected by pressing the INPUT key. The selected input is shown momentarily in the main display.

The audio output can be selected by pressing the keys for headphone, ANALOG and DIGITAL outputs.

6.4 Audio connections to Genelec SAM monitors

Genelec SAM monitors can always be managed and controlled using 9320A.

Audio into a Genelec SAM monitoring system can be routed separately, directly from a digital audio workstation and any audio interface outputs, or using the outputs in 9320A. In all cases, 9320 can control a SAM monitoring system. This means that any size and channel count of a monitoring system can be managed using 9320A.

Selecting the SAM monitor system is done using the four GROUP keys. This requires the GLM GROUP settings to be configured and the GLM software to be running.

When the 9320 is used without GLM software and computer, the output can be selected using the keys for the headphone, ANALOG or DIGITAL output. This turns on the selected output.

The 9320 can be selected to use fixed level line output in analogue and digital audio formats, or the output level can be set to be adjustable. This selection is done as a part of the 9320 configuration in the GLM software.

If the outputs have been configured to be at fixed level then the level is controlled by GLM software in the SAM monitors, and the 9320 will control the output level in SAM monitors. This mode requires the use of GLM software and GLM network management. When 9320 is used in stand-alone mode and this mode is selected the SAM monitors will mute and not play any audio as the GLM software is then sending the level commands to the monitors.

The adjusted output mode is intended for monitor loudspeakers other than the SAM monitors. Then the output level in 9320 is adjusted according to the level setting. This mode is available both for the analogue output and the AES/EBU digital output. The headphone output is always adjusted locally in 9320A. This mode may also be useful for other application where control of level at the 9320 is useful, such as when connecting digital sources, such as a DVD player, to digital inputs on reproduction devices offering no level control, such as a TV set, digital line inputs on amplifiers and similar.

Lights on the GROUP and BASS M turn off when the 9320 is not connected to the GLM software, and these functions are not available.



Fig. 20. GROUP keys select SAM monitor systems.

6.5 USB Audio

The USB audio interface of 9320 uses the standard Mac or Windows audio system. The USB audio output in 9320 supports sample rates up to 192 kHz.

6.6 Using Aural ID Binaural Rendering

To use the Aural ID technology with 9320A, take the following steps,

- install the Aural ID software, available on the Genelec web site.
- connect the headphones you plan to use in the headphone output of 9320A.

- follow the steps outlined in **Aural ID software user manual** to configure and personally calibrate the headphone monitoring.
- in the GLM software, create a Group setting that selects the headphone output and Aural ID, enabling you to quickly select the headphone monitoring enhanced by the Aural ID technology by simply pressing one of the Group selection keys in 9320A.

7 Examples of Use

7.1 Out of the Box

Out of the box, no internal settings of 9320 are set. Then, 9320 can accept audio from any of the inputs, including the USB audio input, and can play audio to any of the outputs. The output level is adjusted using the knob.

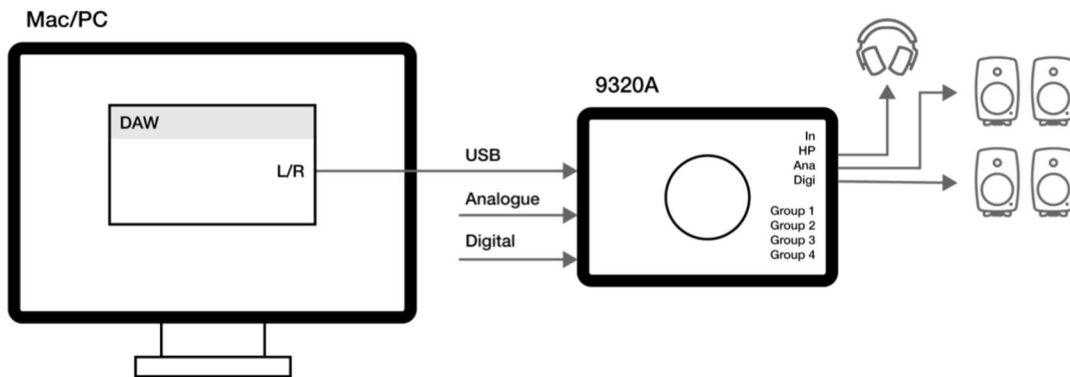

Fig. 21. Out-of-the-box use of 9320A

7.2 Stereo and 2.1 Interfacing with 9320A

The 9320 offers analogue and digital AES/EBU connectivity for stereo audio sources for monitoring. The audio source options are

- USB audio input
- Analogue balanced line input
- AES/EBU digital audio input

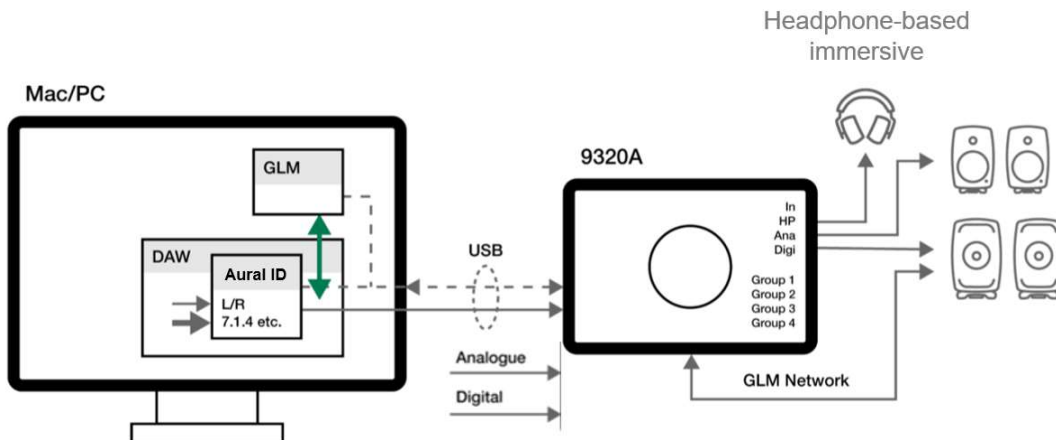

Fig. 22. Stereo and 2.1 monitoring with audio sources. Only USB audio is shown.

GLM software enable complete setup of 9320 and configuration of all the monitoring methods. The 9320 directly supports stereo monitoring and headphone monitoring.

When Aural ID is used, the GLM software can orchestrate the loudspeaker-based monitoring and headphone-based monitoring so that the Aural ID processing is automatically applied to the headphone output.

The loudspeaker-based and headphone-based monitoring situations are best implemented as GLM GROUP definitions. These are directly accessible in the 9320 GROUP keys. The GROUP definition can automatically select the right input and output/monitoring device as well as apply room response compensations to optimize the monitoring accuracy.

7.3 Immersive Monitoring

Monitoring of immersive audio formats with high channel-count monitoring systems is fully supported by GLM software and monitor management is fully supported by 9320 together with GLM software. In this situation, the audio connectivity typically routes analogue or digital AES/EBU audio signals from DAW outboard DACs or audio interfaces to the monitors.

The GLM software support complete system setup, calibration and alignment of monitoring loudspeakers and subwoofers and is compatible with any existing monitoring layout or number of monitoring loudspeakers. The subwoofer support in Genelec SAM line of monitors with GLM software supports any bass management approach needed in a monitoring room.

Immersive audio monitoring is also supported using Aural ID on headphones, and the headphone monitoring situation can be personally calibrated against a loudspeaker-based monitoring system. Switching between monitoring situations and methods can be automated using GLM GROUP definitions.

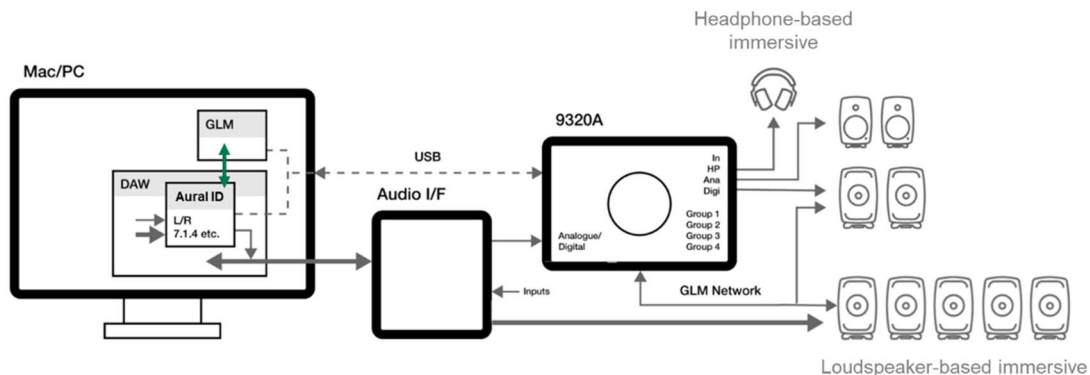

Fig. 23. Using 9320 to manage immersive audio monitoring using Genelec SAM monitors and subwoofers.

8 Using with GLM software

Genelec Loudspeaker Manager (GLM) software enables configuration of 9320A. The GLM User Manual give all details of configuring your monitoring system and it should be your primary source of information.

Download the GLM User Manual at www.genelec.com.

8.1 9320 Firmware Update

8.1.1 How to know a firmware update is available

GLM software indicates the availability of a firmware update for the 9320 with the “UPDATE” tag (see Fig. 1). When this happens, the 9320 Reference Controller properties window, accessible by clicking the 9320 icon, shows the “UPDATE” button next to the Reference Controller icon.

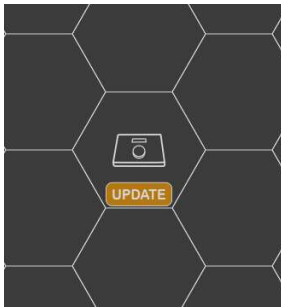

Fig. 24. Indication of available firmware update for 9320A. Clicking the 9320 icon opens the status window with the firmware update start button.

8.1.2 Preparations for the firmware update



NOTE

Before you update the firmware, take the following steps to ensure that the firmware update is possible.

- Finalize the first GLM setup so that you are in the main window – this is after you have gone through creating the first GLM setup after starting the GLM software for the first time; you also enter the main window automatically once you have created at least one System Setup file for GLM.
- Before starting the firmware update, ensure that the USB audio into 9320 is not in use. Select another audio device in the computer sound outputs settings or unselect the use of 9320 as the output device in the computer audio settings.
- To verify that the USB audio is not in use, ensure that the “USB AUDIO” text under the display turns off; this indicates that the 9320 USB audio input is not in use.

After these steps you are ready to start the firmware update.

8.1.3 Performing the firmware update

To start the firmware update, click on the 9320 to open the device status window. Then, find the “update” button (see Figure) and click this button.

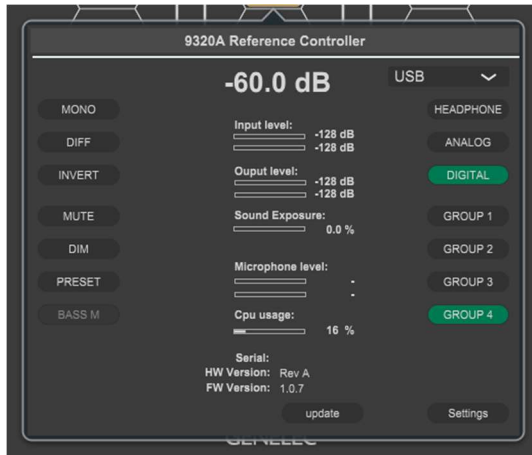

Fig. 25. The status window shows the firmware 'update' button when a firmware is available.

The firmware update includes the following steps:

- firmware downloads over the USB cable into 9320 device
- installing the 9320 firmware update inside the device
- device reboot (device appears to be off; do not remove the USB cable!)
- return online in the GLM software.

Re-booting the 9320 after the firmware update is automatic after firmware installation and usually takes less than **1 minute**; during the reboot, the 9320 appears to turn completely off and then comes back on with the normal power-on sequence.



WARNING

While the firmware update runs and the device appears to be off, do not detach the USB cable, do not turn off the computer, and do not remove power into 9320 device. **Do NOT turn off power or detach the USB cable into 9320 even if the 9320 appears to be completely inactive.** Wait at least one minute.

To update the firmware, click on the "UPDATE" button. Then, follow instructions on the screen, and wait until the firmware update is complete.

Do not turn off power to 9320 when the firmware update is in progress. Do not detach the USB cable or turn off a USB power supply during the firmware update.



WARNING

In some systems, in order to gain full access to the new and updated functionality, it may be necessary to restart the computer and GLM software after a firmware update.

8.1.4 Verifying the firmware update

The firmware version is visible on the splash screen visible during the 9320 power-up, under the “SAM Reference Controller” text. Verify that the firmware version number is correct.



Fig. 26. The start-up splash screen shows the firmware version number on the last line.

The firmware version number is also visible in the GLM software, in the 9320 status window after the “FW Version” text. To find this, click the 9320 icon in the GLM software main window.

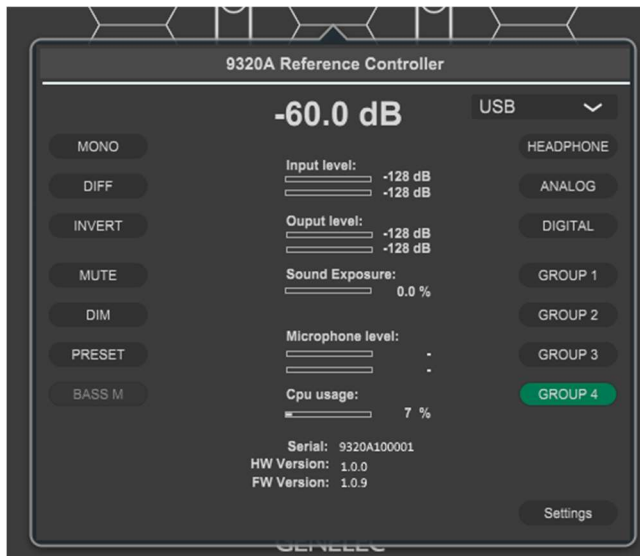

Fig. 27. The status window shows the installed firmware version.

If the firmware version does not match the new firmware version number, then the firmware update has not actually taken place. To fix this issue, carefully follow the steps to enable the firmware update to take place.

To ensure complete functionality with the new firmware, it may be useful to momentarily detach the USB cable into 9320A, to allow a complete re-powering of the 9320 device from the power-down state. When you detach the USB cable, wait for at least 5 seconds before re-attaching the USB cable to reapply power to 9320A.

8.2 9320 Device Configuration in GLM

The 9320 Reference Controller is configured entirely using the GLM software. A Mac or Windows computer is needed for the configuration. Download and install GLM software at www.genelec.com/glm. Once the GLM software is installed, two documents are created in the computer describing the use of the GLM software

- GLM Quick Guide
- GLM Operating Manual

Follow these documents to create the System Calibration for your SAM Monitoring System and the 9320 Operating Manual to configure the 9320A.

The GLM documents show the GLM Adapter as the device providing connectivity to a computer USB port. 9320 replaces the GLM Adapter functionality and provides also many additional functions and features.

Once the 9320 symbol in the GLM user interface is placed in the user interface, click on the 9320 icon to open the 9320 status display. This display contains a button to enter the configuration display. All configuration of 9320 can be done in the configuration display. Note that most of the 9320 configuration settings are not available in the 9320 device menu.

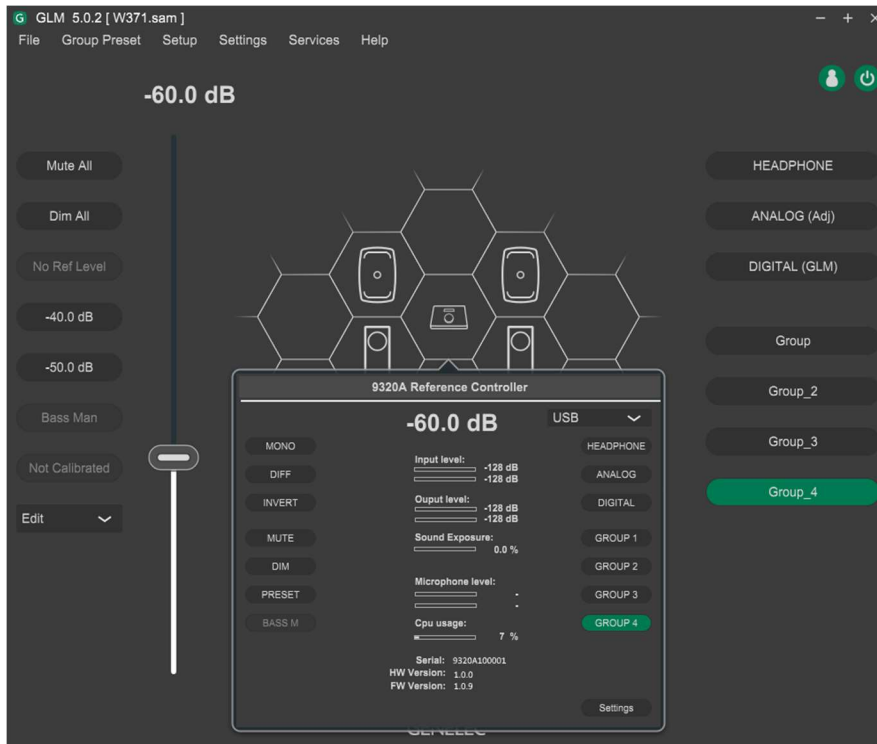

Fig. 28. The info display of 9320 is accessible by a mouse click on the 9320 icon. The configuration page entry is done by clicking 'Settings' button.

8.2.1 Common Settings Configuration

These settings are configured by the user for 9320 in the GLM software

- Measurement microphone: serial number assigned in the 9320 is shown here, and this affects the measurement accuracy – the correct microphone serial number should be selected for the highest accuracy.
- Measurement weighting (options Z, A, C) – selecting the weighting option here assigns the weighting used for the SPL measurement.
- Key light turns on and off in sync with the display (yes, no) – this control affects the lighting of the 9320 Reference Controller keys. The display turns off automatically after a time-out period.

Using this control you can select also the key lights to turn off automatically with the display. Pressing any key or turning the level control knob resumes the lights.

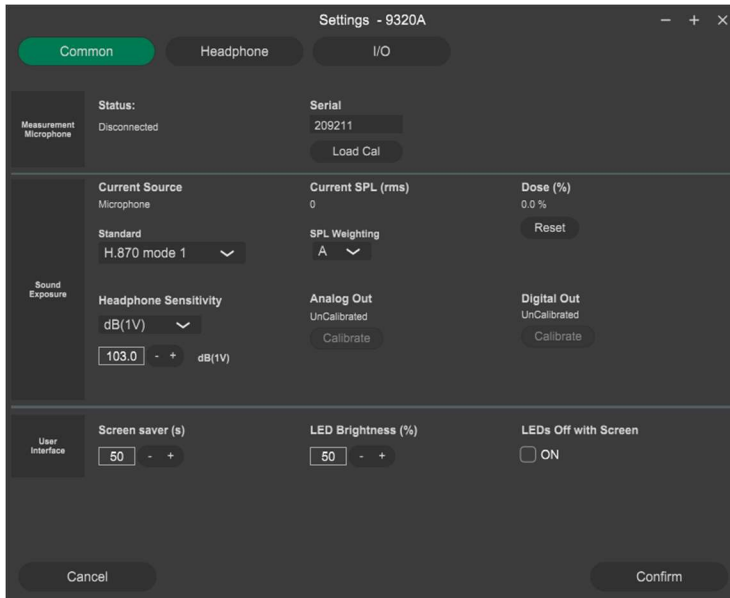

Fig. 29. The configuration display of 9320 has three sub-pages, “common”, “headphone” and “I/O”. Click the buttons on the top of the window to select the sub-page.

- Display turn-off time – the 9320 display always turns off after a time, to increase the display life time. However, with this control the time-out duration can be adjusted to suit the application.
- Key light brightness – the brightness of the 9320 key lighting can be adjusted to suit the lighting conditions in the working environment of the 9320A.
- Noise dose standard – there are several standards for estimating the sound exposure (noise dose). The standard to be applied can be selected with this “Standard” drop-down menu in the “Sound Exposure” field.
- Zeroing of the accumulated noise dose can be done by clicking the “Reset” button in the “Sound Exposure” field – the sound exposure (noise dose) is accumulated automatically. Using this control, the current sound exposure (noise dose) figure can be zeroed.

8.2.2 Headphone Settings Configuration

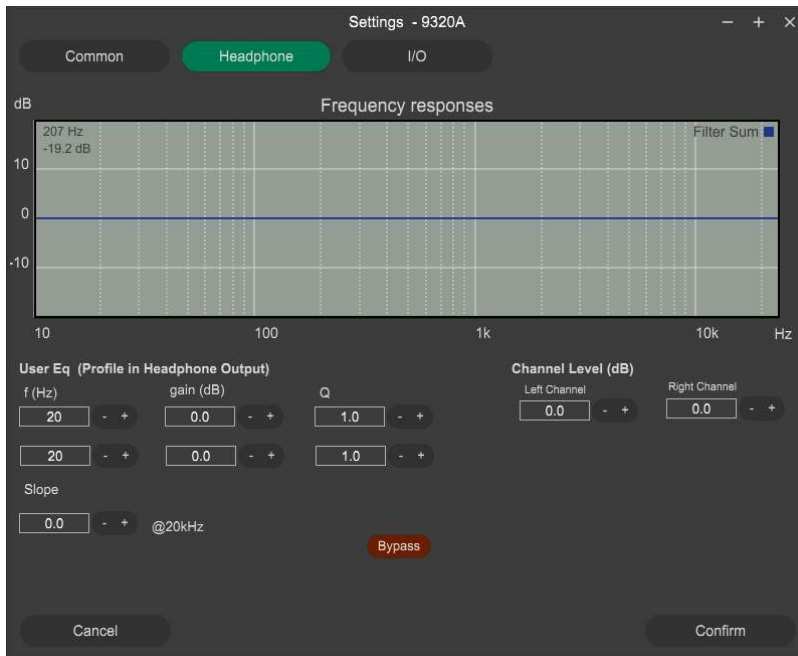

Fig. 30. The headphone configuration of 9320

These settings are configured by the user for 9320 in the GLM software

- Headphone left/right channel level control can be used to ensure that the left and right side of a headphone produce the same SPL; when this happens a monophonic audio feed into the headphones appears to be at the center point in the head.
- User equalizer (UEQ) settings for a headphone – the user equalizer enables removal of disturbing midrange colorations using the two parametric filters and an overall balancing of the sound balance from bass to treble such that the audio reproduced by the headphone is neutral and has good resolution, enabling reliable work with audio. The correct setting always depends on both the headphone as well as the listener, and should be adjusted personally for a certain pair of headphones.

8.2.3 Input/Output Settings Configuration

These settings are configured by the user for 9320 in the GLM software

- Line input maximum level, two options 12 dBu or 24 dBu maximum – this is selected to suit your analogue source device output capacity
- Input levels can be trimmed such that switching between the inputs can be done without adjusting the level control
- Output levels trim for the analogue line output, AES digital output, and headphone output – the purpose of output level trims is to enable switching between the three outputs without having to adjust the output level, making output switching easy and intuitive

- Analogue and digital output selections (options are “GLM (fixed)” and “Adjustable”) select the method of implementing the level control for the analogue line output and digital AES/EBU output – in 9320 the level is set using the knob and this field selects how the level setting is implemented.

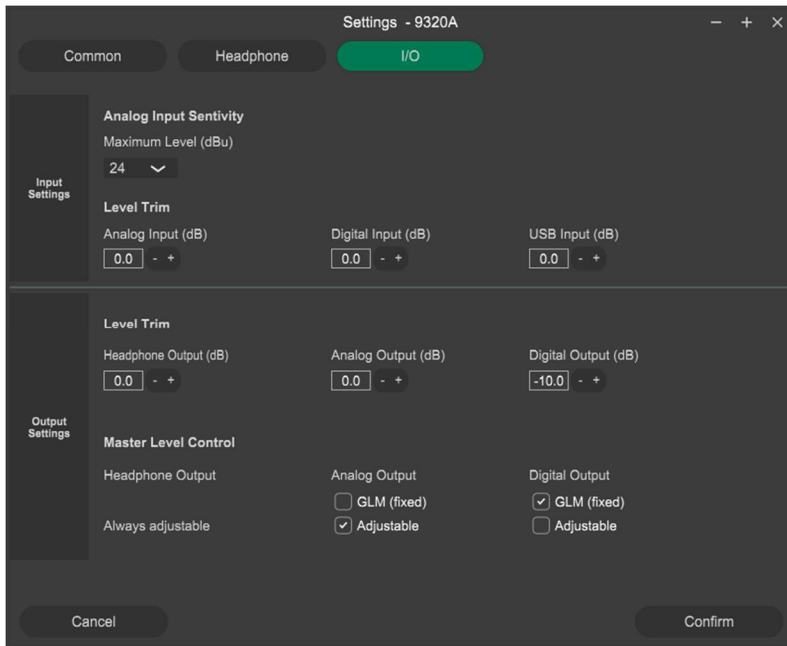

Fig. 31. The input/output configuration of 9320A.

When the “GLM (fixed)” is selected and the GLM management network cable is connected to all SAM monitors and subwoofers, the level is adjusted inside the SAM devices; this is ideal as the signal level going to the monitors and subwoofers can be maintained high for the highest audio quality.

When the “Adjustable” is selected, the 9320 adjusts the audio level at the analogue or AES output. This method can be used with all devices that do not use the GLM management network.

Please note that when the GLM network cable is connected while you select the “Adjustable” option for the level control, automatically mutes all SAM monitors and subwoofers. This happens because this selection does not send the level control information over the GLM management network.



WARNING

When you are using loudspeakers that do not use the GLM management, avoid using the “SAM” level control settings as in this mode the output level from the 9320 is very high, in order to ensure the best possible audio quality, and this can result in excessive audio level which may be dangerous to your hearing.

**WARNING**

When you store the GLM settings in loudspeakers, these settings only come to force if the Genelec SAM monitors and loudspeakers are detached from the GLM network controller (Adapter device or 9320A) and are re-started (powered down and then up again). Once you do this, you should use the 9320 “Adjustable” mode to control the output level of the audio signal going to loudspeakers and subwoofer at the output of 9320 Reference Controller.

8.2.4 9320 Settings Set as a Group Property

Certain settings are automatically copied to 9320 when these settings are set in the GLM software. These are

- Level preset value
- Volume related settings: Reference level, maximum level, start-up level

This is the appearance of the GLM configuration page for 9320A.

Consult the GLM User Manual for more information on the Group concept and how to use it.

8.3 Headphone Output Calibration

8.3.1 Headphone Specific Data

The headphone sensitivity explains how high sound pressure (SPL) is generated at the ear for a certain magnitude of electrical headphone output signal.

The headphone sensitivity defaults as OFF and then the SPL display and noise dose are not calculated for the headphone output.

The headphone sensitivity is set as a part of the 9320 configuration in the GLM software. This value is used in displaying the SPL for the headphone output, and in calculating the noise dose when using the headphones.

8.3.2 Personal Calibration of Headphone Sound

Headphone calibration controls enable personal calibration of specific headphones for a 9320 device.

The user equalizer (UEQ) offers a wideband ‘Slope’ adjustment to control the overall sound balance in a headphone, to establish the correct relative level of the bass frequencies and very high frequencies relative to the midrange level.

In addition to the overall sound balance control, two parametric equalizers (PEQ) are available. These are typically used to calibrate the midrange presentation sound balance to be neutral.

Balance settings are available for the left and right side to put the central sound image at the right location for the listener. This adjustment should be done as the last step.

In order to find the correct neutral sound character, it is good to use familiar music and speech samples as familiar material enables more precise understanding of the sound balance details.

It is also good to keep in mind that unit-to-unit variations between headphones are significant, and how the headphone seats on a person's head affects the sound balance. These typically make a calibration specific to a certain pair of headphones used by a specific person.

8.3.3 Output level trim

9320 headphone output gain adjustment enables the monitor sensitivity to be set the same as for other outputs or the GLM Groups controlling audio presented directly from DAW outputs to monitors. This enables smooth switching between the outputs in 9320 without having to adjust the volume setting after the switch-over.

8.4 Measurement Microphone Placement

As a part of the System Calibration, the system is acoustically calibrated. To do this, use the Genelec measurement microphone supplied with 9320A. Place the microphone on a stand at the listening location of the engineer, with the microphone pointing upwards, and the microphone top at the height of the engineer's ear in normal working position.

Run the microphone cable to the 9320 and connect to the microphone input on the 9320 controller. This is the icon shown at the microphone input



Follow the Quick Guide or Operating Manual to create the System Setup file.

Multipoint system calibrations use several microphone positions. When a multipoint calibration is done, first place the microphone to the primary position and then proceed to more positions. The primary position is typically at the main listening position.

8.5 Calibrating SAM monitors on GLM network

GLM software can fully set up your monitoring system. GLM software works with Genelec Smart Monitoring Devices to minimise unwanted acoustic influences of the monitoring room and helps your mixes sound great, everywhere. GLM system calibration includes access to the powerful GRADE report, extending GLM's scope beyond ultra-precise system calibration, to complete in-depth room and system acoustical analysis.

Download GLM software at the Genelec web site (www.genelec.com). Install the GLM software. The software comes with an Operating Manual explaining the process of calibrating the monitoring system. Follow the GLM software instructions to measure and set up your monitors.

The monitors can be calibrated for one listening position at the time and there can be several such positions, selectable as monitor group settings. Monitors can also be calibrated for a wider listening area, using multiple measurement microphone positions and a calculation of the common correction needed over this area, and in the same way, there can be several such area calibrations stored as group settings. As the number of GLM calibration files is not limited, there is practically no limit to how many system calibrations can be designed.

GLM software can calibrate and directly support any monitoring system layout up to tens of monitors and subwoofers in one room, including very high channel count immersive system. For more information, see <https://www.genelec.com/glm>.

After calibration, the SAM monitoring system sensitivity can be adjusted to be subjectively the same as the headphone sensitivity by using the GLM system sensitivity setting. This enables smooth switching between the outputs in 9320 without having to adjust the volume setting after the switch-over.

8.6 Level Alignment for Other Monitors

Monitoring loudspeakers from other manufacturers can be set up using the features built in 9320A. These features are configured using the GLM software.

Sensitivity of a monitor explains how much audio output is generated for a certain magnitude of input. The sensitivity of the monitors connected to the output in 9320 can vary between models.

The 9320 analogue and digital output gain adjustments enable the monitor sensitivity to be configured the same as other devices, such as the headphones. This enables smooth switching between the outputs in 9320 without having to adjust the volume setting after the switch-over.

8.7 Optimizing Signal-to-Noise Ratio

8.7.1 Input Level Optimization

The input level trims in the 9320 I/O configuration section as well as the Analog Input Sensitivity range selection (12 or 24 dBu maximum) enable optimization for the best signal to noise when interfacing to audio source equipment. The principle is that the source equipment should use large output signal into 9320A. This is particularly important when connecting analogue source devices.

8.7.2 Analogue Audio

The sensitivity of the monitor system can be adjusted using the GLM software. It is advantageous to keep the incoming signal level high and to lower the level in the monitor using the GLM level control to maintain highest digital resolution. Frequently, the best signal-to-noise ratio can be obtained when the GLM volume setting is set to -10 to -15 dB when the analogue input is controlled in the mixing console.

8.7.3 AES/EBU Audio

For a digital –30 dBFS input 9320 Reference Controller produces 100 dB sound level (SPL) at 1 m in free space when the volume is set to the maximum (0 dB). The sensitivity of the monitor system can be adjusted by the volume setting in the GLM software.

After calibration, the SAM monitoring system sensitivity can be adjusted to be subjectively the same as the headphone sensitivity by using the GLM system sensitivity setting. This enables smooth switching between the outputs in 9320 without having to adjust the volume setting after the switch-over and also improves the system sign-to-noise ratio.

8.8 SPL Display and Sound Exposure Logging

Several occupational safety standards exist for assessing the personal noise dose. The GLM configuration allows selection of the standard to apply in noise dose calculation. Typically, the noise dose calculation is set according to the local national standards.

The measurement microphone sensitivity is automatically configured once the correct Genelec microphone serial number is set. This loads the calibration data into the 9320 to enable accurate SPL display.

Several weighting options are available for the SPL display. The weighting option is selected in the GLM configuration.

The audio signal for the sound level and noise dose measurements can come from the measurement microphone in case of loudspeaker-based monitoring or from the audio input directly in case of headphone monitoring.

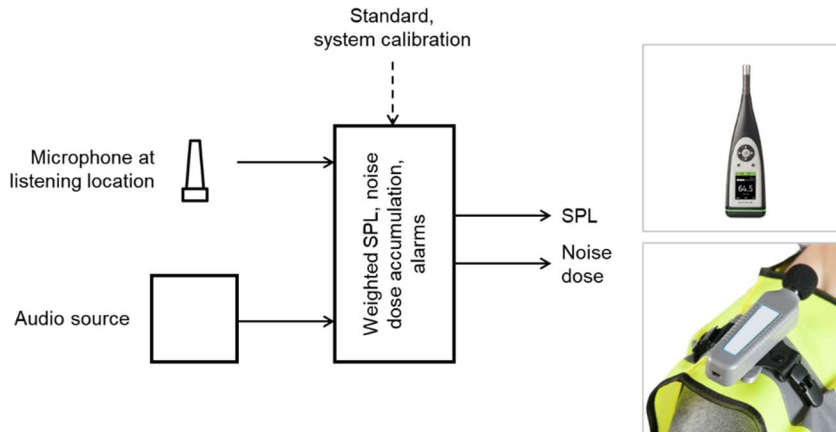

Fig. 32. Principles of obtaining the audio signal for SPL measurement and noise dose integration.

8.8.1 Principles of Exposure Calculation

The noise dose calculation (Table 1) works with the assumption that a constant noise level under the noise dose safety limit for the duration of accumulation set in the national standard is unlikely to result in a permanent hearing damage over time. The calculation of accumulation assumes that the listener is exposed to the noise for the duration of a standard working day. Then, the noise dose accumulates to 100% during the standard working day, and this describes the limit of safe working conditions.

In media work, audio signal level variation is dynamic, and this must be considered. This is done by using the exchange rate. The exchange rate explains how much dose accumulates at various listening levels. This means that if the noise level is higher by the amount given as the threshold level, the duration of accumulation is speeded up. The accumulation rate is doubled if it exceeds the threshold by the amount shown in the exchange rate. If the threshold is at 80 dB SPL, but the actual sound level is 86 dB SPL, the daily dose accumulates in $\frac{1}{4}$ of the standard working day when the exchange rate is 3 dB and the sound level exceeds the threshold by $2 \times 3 \text{ dB} = 6 \text{ dB}$. When the noise level is below the noise dose threshold limit, this low level is considered safe and does not contribute to the noise dose for the day.

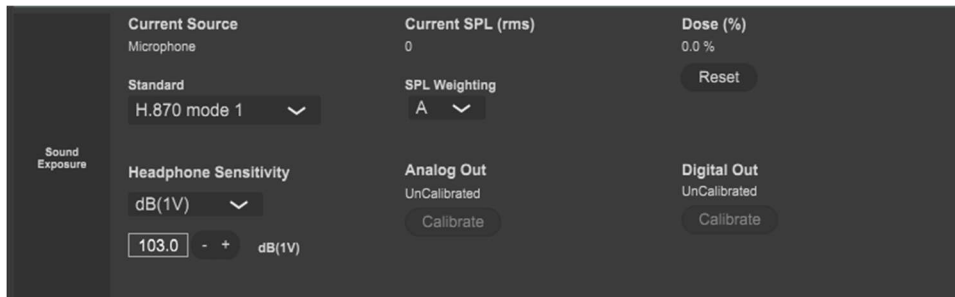

Fig. 33. Selecting the noise dose standard, SPL reading weighting and reset of accumulated dose.

9320 Reference Controller can follow the accumulation of the noise dose due to listening to audio and enables the accumulated dose to be monitored. The standard for accumulating the dose is selected in the 9320 setup using the GLM software. The dose is naturally a personal quantity, so if the same 9320 dose is valid for one person working in the monitoring space. If several persons take turns to use the space, single dose calculation in 9320 is not accurate for an individual.

In terms of selecting the noise dose standard to use, the highest protection for hearing is obtained using the standard setting the criterion level and the rate to the lowest values. In this regard, the use of the ITU-T recommendation H.870 mode 1 or mode 2 settings are considered a safe choice. It is always advisable to use low monitoring level for long duration monitoring and only increase the monitoring level for short periods of time when needed for maximum audibility.

Table 4. Noise dose calculation standards available in 9320A

Parameter	H.870 MODE 1	H.870 MODE 2	EU-OSHA (EU)	OSHA/MSHA (US)	NIOSH/ACGIH (US)	DOD 3dB (US)	DOD 4dB (US)	Explanation
L_{crit}	80	75	85	90	85	85	85	Criterion level, unit dB SPL The sound level accumulating 100% dose during a criterion duration of T_{crit} hours.
T_{crit}	8	8	8	8	8	8	8	Criterion duration, unit hours This is the assumption of the duration of a standard working day.
rate	3	3	3	5	3	3	4	Exchange rate, unit dB Dose accumulation speed is doubled when the sound level increases by 'rate' dB.
L	77	72	80	80	80	80	80	Threshold (or cutoff) level The sound level considered safe. No dose is cumulated when the SPL is below L.

Some standards related to occupational noise exposure include the following

- ITU-T Recommendation H.870 (International)
- ISO9612, ISO1999 (International)
- EU Directive 2002/49/EC (Europe)
- OSHA 1910.95 (USA)

Some standards related to the accuracy needed for measuring personal exposure include

- IEC 61252 (Personal sound exposure meters, international)¹

¹ The personal sound level meter accuracy grade corresponds to that for an integrating sound level meter which complies with the Type 2 requirements of IEC 60804 for an A-weighted sound pressure level range from 80 dB to 130 dB and a nominal frequency range from 63 Hz to 8 kHz.

8.8.1 How 9320 obtains exposure

The 9320 can continually measure the sound level at the listening position or estimate the sound level at the ears when using headphones. Using the continuous evaluation of the sound level at the listening position and the exchange rate information, the 9320 noise dose calculator continually accumulates the sound exposure (noise dose), and this is useful for understanding the safe exposure and hearing health risk in media work.

When the measurement microphone is used, a complete noise exposure can be measured such that the measurement contains the effect of all noise at the listening location, not only the effect of the audio content playback.

In order to obtain an accurate noise dose assessment for a mixing engineer, place the measurement microphone permanently in the vicinity of the listening location, for example by hanging the microphone in the ceiling above or close to the engineering position.

For headphones, the estimation is done using the input signal, and the noise dose calculation indicates the impact of the audio content playback, alone. The headphone sensitivity setting is available in the GLM configuration for the 9320. For very accurate estimation of the listening SPL when using headphones, this figure should be set using a reference sound level measurement at the ears when using the headphones. If the headphone sensitivity is set using a headphone's data sheet nominal sensitivity, the sound level estimation may not be accurate in all cases. In calculation of the dose, the sum of the left and right channel content is considered. When the headphone sensitivity data is missing, the headphone audio does not contribute to the sound exposure accumulation.

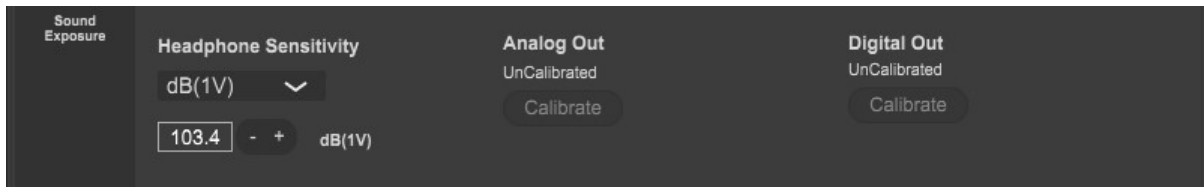

Fig. 34. Setting for the headphone sensitivity.

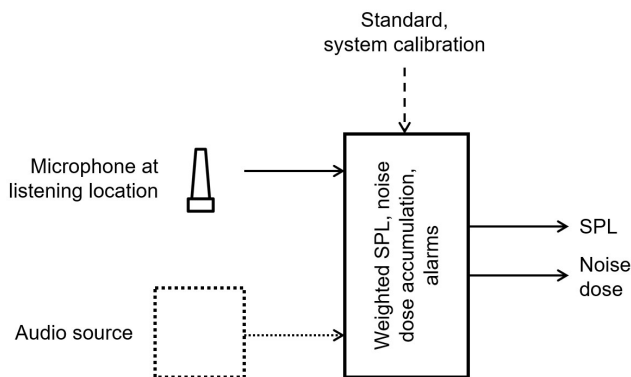

Fig. 35. Inputs to the sound exposure support both the microphone SPL measurement and measurement at the audio source.

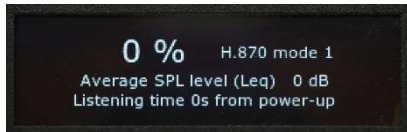

Fig. 36. Accumulated sound exposure dose display. In this case, the ITU-T Recommendation H.870 settings are used for dose accumulation. Also the average SPL level and the accumulation time are shown.

Table 5. Source of sound exposure audio level.

Output	Mic connected	Sound exposure (noise dose) accumulation
Headphone	Yes	From headphone signals
	No	From headphone signals
Analog	Yes	From mic signal
	No	Dose does not accumulate
Digital	Yes	From mic signal
	No	Dose does not accumulate
GLM control Audio does not go through 9320	Yes	From mic signal
	No	Dose does not accumulate

8.9 Measurement Microphone and SPL Weighting

The frequency weighting used for the sound level measurement and the sound exposure measurement are set in the 9320 configuration page, accessible in the GLM software.

When the measurement microphone changes, the new measurement microphone can be configured in 9320 using GLM software. The measurement microphone configuration affects the GLM AutoCal system calibration accuracy, sound level metering and sound exposure calculation.

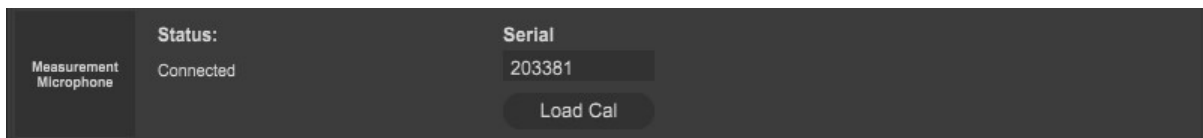

Fig. 37. Setting the microphone serial number.

The microphone is configured by setting the serial number on printed on the microphone body in the GLM software and by pressing 'Load Cal' to find the correct microphone calibration. The microphone calibration is fetched in the Genelec Cloud, and for the calibration setting to succeed, the user must be registered as a MyGenelec user and be logged in on his personal MyGenelec account. After reading, the microphone calibration is stored into the 9320 Reference Controller, and thereafter GLM reads the microphone calibration in the 9320 Reference Controller.

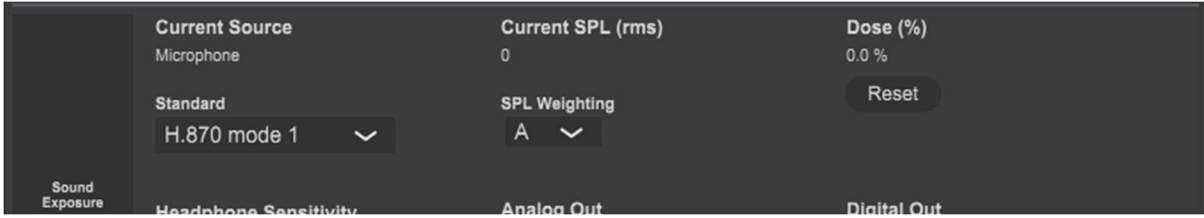

Fig. 38. Seeing the current SPL and selecting the SPL reading weighting.

9 Independent Use of 9320 Without GLM

Before the independent operation, the 9320 should be configured using GLM software and computer. Configuration of the 9320 always uses a computer and the GLM software. Consult the GLM User Manual section on 9320 configuration for more details.

Once the 9320 device configuration has been completed using the GLM software, settings inside 9320 have been set. After this, these settings are available in the Independent use.

Use the GLM software to write the settings into the monitors ("Store the Settings") in order to make the AutoCal calibration available when the 9320 is used in the stand-alone mode.

After the 9320 has been configured, 9320 can be used as an independent Monitoring Controller, without the GLM software or computer. For this use, USB power supply is connected to one of the USB type C connectors on 9320A.

In the independent mode, the following functions are available

- Headphone functions
- Audio input and output on line in/out and AES/EBU digital audio
- Volume control functions including MUTE, DIM, PRESET
- MONO, DIFF and INVERT functions for the stereo outputs
- Sound exposure (noise dose) monitoring
- SPL monitoring

The GROUP and BASS M keys are not available in the independent mode. The light at these keys turns off in the independent mode to indicate this.

In the independent mode, the GLM and Aural ID Plug-In specific functions are not available in 9320 as these functions are implemented in GLM and Aural ID Plug-In software and not in 9320.

10 Function Reference

This section present details on the functions available in 9320A.

10.1 MONO

MONO is a mono signal produced by $SUM = 0.5 (L+R)$ inserted into L and R channels. Note that the sum signal is attenuated by 6 dB, preventing significant subjective level change, and clipping when the MONO is used.

The MONO signal is attenuated by 3 dB.

Pressing the MONO key reproduces the sum on the left and right channel. MONO amplifies the correlated content, the content that is the same in the left and right channels, and this is useful for checking the level and content that is the same in left and right channels.

The MONO key is also very handy for understanding the location of the centre image. Pressing the MONO key produces a signal that should appear in the midpoint between the left and right monitors. This helps the listener quickly find the optimal listening position by moving slightly to the left or right such that the mono image is located at the correct middle location. Moving to this location ensures that the stereo stage has the correct left-right structure for monitoring.

10.2 DIFF

DIFF is a mono signal produced by subtracting the right channel content from the left channel content, $DIFF = 0.5 (L-R)$, and inserting the difference signal into the L and R channels.

The DIFF signal is attenuated by 3 dB.

Pressing the DIFF key enables quick listening of the uncorrelated content in the stereo recording. Frequently the uncorrelated content is related to the acoustical ambience and background sound, such as audience sound and applauds.

The DIFF key reduces the level when the left and right channel content is correlated, while DIFF amplifies the level for the content that is out of phase in the left and right channels. Therefore, the DIFF key is an effective method for understanding the level of the out-of-phase content in the stereo signal.

The DIFF function can also make certain quality problems in recording more audible as it attenuates the content that is the same in the left and right channels.

10.3 INVERT

INVERT is a stereo signal (L, -R), and if there is content in the centre of the original stereo input, this becomes small, close to zero, and the differences in stereo are amplified.

The common content in the stereo signal moves to undefined directions when the INVERT is engaged while the uncorrelated content may become more apparent in the centre of the sound stage. This can help understanding the structure of the stereo recording.

10.4 MUTE

MUTE key silences all outputs. Then, the MUTE text has red colour. Pressing the MUTE key again unmutes all the outputs. MUTE state is also visible in GLM software.

10.5 DIM

DIM key reduces the output level by a fixed amount (-20 dB) on all outputs. Then, the MUTE text has yellow colour. Pressing the DIM key again un-mutes all the outputs. DIM key is also visible in GLM software.

10.6 PRESET

PRESET key sets the level to the value set as the first preset level in GLM. The first preset level in GLM defaults to -40 dB FS, but this can be set by the user. When the level is at the PRESET value, the PRESET text has green colour. Turning the knob to change the level causes the green colour to turn white, indicating that the listening level is no longer at the PRESET level. The PRESET key state also in the GLM software.

To set the value of the preset level, use the GLM software. In GLM software, adjust the level to the desired value, then select the menu item 'Group Preset' | 'Set Preset Level' and then select 'Set Current Level to Preset 1' option. This is the preset level activated when clicking the PRESET key on 9320A.

10.7 BASS M

BASS M key bypasses bass management when active. This function is available when a Genelec Smart Subwoofer is in use and the bass management has been set up using GLM.

The BASS M enables quick comparison of the sound quality when the lowest frequencies are reproduced in the loudspeaker instead of the subwoofer. Using this control may be useful to understand how the use of subwoofer affects the low frequency reproduction. For a properly calibrated subwoofer, the effect of using the bass management bypass is small.

11 Operating Environment

11.1 Operating and Storage Environment

The device is designed for indoor use only. The operating ambient temperature of 9320 should be 15-35 °C (50-95 °F) and the non-condensing relative humidity 20-80 %.

When the product has been stored or transported in cold and is then taken into a warm room, the product should warm up to ambient temperature inside an unopened packing for at least three hours before opening the packing and connecting to the USB power. This is needed to prevent condensation of moisture inside the device.

11.2 Technical data and graphs for 9320A

The 9320 uses power from one USB connector at a time. When both connectors are connected, the PWR connector is used for power. The computer USB-C power input limits to 2.5 W input power (500mA input current). When the PWR connector is in used, the output power available to the headphone is slightly higher; the benefit is +0 dB to 2.5 dB more output, depending on the load impedance. The PWR input connector is designed to work with a standard 5 V 1A USB power adapter.

Table 6. Mechanical and power

Parameter	Unit	Value
Weight	kg (lbs)	0.890 (2.0)
Height	mm (in)	60 (2 3/8)
Width	mm (in)	190 (7 1/2)
Depth	mm (in)	139 (5 1/2)
Supply voltage, USB type C connector	VDC	5
Operating power consumption, no outputs driven	W	1.5
Operating power consumption, using computer connector USB-C	W	< 2.5 (typ. 2.25)
Operating power consumption, using PWR connector USB -C	W	< 3.5
Sleep mode power consumption	W	0.125
Operating temperature	C (F)	15 – 35 (60 – 95)
Operating humidity, noncondensing	%	10 – 80

Table 7. Typical system performance

Parameter	Unit	AES/EBU input to headphone output	AES/EBU input to line output	Line input to line output	Line input to headphone output	Line input to AES/EBU output
Frequency response, -3 dB point	kHz	0 – 46	0 – 46	0,2 Hz – 46	0,2 Hz – 46	0,2 Hz – 46
Frequency response flatness, measurement range 10Hz – 40 kHz	dB	± 0,1	± 0,1	± 0,1	± 0,1	± 0,1
Channel gain difference	dB	< 0,1	< 0,1	< 0,1	< 0,1	< 0,1
Dynamic range	dB	126	126			
Lo Gain		(250-600Ω)		121	121	123
Hi Gain				118	118	121
Noise (A weighted), measurement range 20 Hz – 20 kHz, (Vol. -0dBFS)	μV	3	3			n.a.
Lo Gain				5,5	5,5	
Hi Gain				7,5	7,5	
THD+N distortion and noise (Lo Gain), maximum volume setting, input signal -6 to 0 dBFS 1 kHz, measurement range 20 Hz - 20 kHz	%	< 0,0004	< 0,0004	< 0,0005	< 0,0005	< 0,0004
	dB	< -108	< -108	< -106	< -106	< -108
THD+N distortion and noise (Hi Gain), maximum volume setting, input signal -6 to 0 dBFS 1 kHz, measurement range 20 Hz - 20 kHz	%	n.a	n.a	< 0,0006	< 0,0006	< 0,0005
	dB	n.a	n.a	-104	-104	-106
Input to output latency	ms	3,2	3,2	2,1	2,1	2,0
Crosstalk 10kHz -10dBFS Load impedances	dB		-120	-120		-120
100 kΩ,		-120			-120	
150 Ω,		-87			-87	
32 Ω		-74*			-74*	
* When using small headphone loads, most of the crosstalk is caused by impedance of common ground of TRS connector.						

Table 8. Typical output performance

Parameter	Unit	Headphone output	Analog line output	AES/EBU output
Connector		1/4 in TRS	1/4 in TRS	XLR male
Electrical interface		Split supply, ground referenced	Balanced	AES 3
Maximum output voltage	V RMS (dBu)	6 (17.8)	6 (17.8)	n.a.
	V peak	10.6	10.6	n.a.
	V peak-to-peak	21.3	21.3	n.a.
Output impedance	Ω (ohm)	1.5	80	110
Max output current	mA	120	n.a.	n.a.
Headphone maximum output power. Both left and right channels loaded. The power feed from the computer USB-C connector (in parenthesis when the PWR USB-C input is used for power).	mW (16 Ω)	90 (123)	n.a.	n.a.
	mW (32 Ω)	120 (211)	n.a.	n.a.
	mW (100 Ω)	123 (203)		
	mW (150 Ω)	141 (173)	n.a.	n.a.
	mW (250 Ω)	100 (144)	n.a.	n.a.
	mW (600 Ω)	53 (53)	n.a.	n.a.
Frequency response (-3 dB point)	kHz	0 – 46	0 – 46	0 – 46
Frequency response flatness, range 10Hz – 40 kHz	dB	± 0.1	± 0.1	± 0.01
Channel gain difference	dB	< 0.05	< 0.05	< 0.01
Dynamic range	dB	126 (Load 250-600 Ω)	126	138
Noise A weighted (20-20 kHz)	μ V	3	3	n.a.
Distortion and noise (250-600 Ω) Input -6 to 0 dBFS 1 kHz input 20 Hz to 20 kHz measurement range.	%	< 0.0004	< 0.0004	n.a.
	dB	< -108	< -108	n.a.

Table 9. Typical input performance

Parameter	Unit	Analogue line input	USB input	AES/EBU input
Connector	mm (in)	6.3 (1/4) TRS	USB-C	XLR female
Interface type, electrical		Balanced	USB 2.0 High Speed	AES 3
Maximum input voltage (Lo Gain)	dBu	24	n.a.	n.a.
Maximum input voltage (Hi Gain)	dBu	12	n.a.	n.a.
Input impedance, differential	Ω (ohm)	6600	n.a.	110
Frequency response, -3 dB	kHz	0.2 Hz - 46	0 – 46	0 – 46
Samplerates	kHz	n.a.	44.1 48 88.2 96 176.4 192	32 – 192
Sample word length	bit	n.a.	24	16 – 24
Frequency response flatness 20 Hz - 40 kHz	dB	± 0.05	± 0.01	± 0.01
Channel gain difference	dB	< 0.05	< 0.01	< 0.01
Dynamic range (A weighted) 20-20kHz Lo Gain Hi Gain	dB	123 121	138 (24 bit)	138 (24 bit)
Equivalent input noise (A weighted) 20-20kHz Lo Gain Hi Gain	μ V	9 3	n.a.	n.a.
THD+N distortion and noise (Hi Gain), input signal -6 to 0 dBFS 1 kHz, measurement range 20 Hz - 20 kHz	%	0.0005	n.a.	n.a.
	dB	-106	n.a.	n.a.
Distortion and noise (Low Gain), input signal -6 to 0 dBFS 1 kHz, measurement range 20 Hz - 20 kHz	%	0.0004	n.a.	n.a.
	dB	-108	n.a.	n.a.

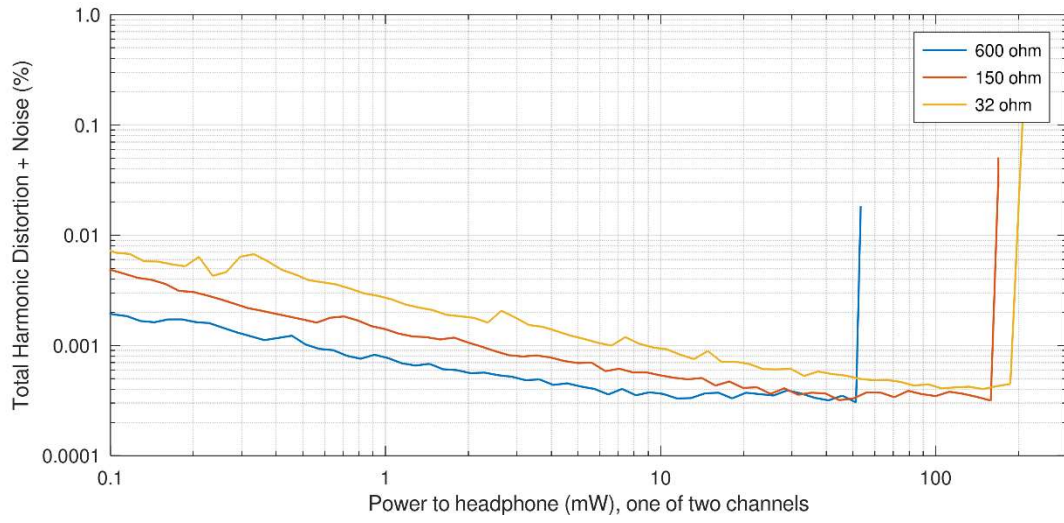

Fig. 39. Typical total harmonic distortion + noise performance of the headphone output at various headphone impedances.

12 Notes

12.1 Maintenance

Use moist soft textile cloth for wiping the surfaces on the 9320A. The device is not intended to be operated out of doors and is not sealed for moisture or dust. Do not expose 9320 to direct sunlight for extended periods as this can affect the materials and can heat the electronics to excessively.

12.2 Safety Warnings

Although this product has been designed in accordance with international safety standards, to ensure safe operation and to maintain the monitor under safe operating conditions, the following warnings and precautions must be observed:

Servicing and adjustment must only be performed by a certified Genelec service. The enclosure or the 9320 unit must not be opened as this may result in loss of performance.

To prevent fire or electric shock, do not expose any part of the product to water or moisture.

Do not place any objects filled with liquid, such as vases on or near any part of the product.

12.3 Symbols

WEEE Directive 2012/19/EU.

Power/standby switch

12.4 Compliance to FCC Rules

This device complies with part 15 of the FCC Rules. Operation is subject to the following two conditions:

- This device may not cause harmful interference, and
- This device must accept any interference received, including interference that may cause undesired operation.

Note: This equipment has been tested and found to comply with the limits for a Class B digital device, pursuant to part 15 of the FCC Rules. These limits are designed to provide reasonable protection against harmful interference in a residential installation. This equipment generates, uses and can radiate radio frequency energy and, if not installed and used in accordance with the instructions, may cause harmful interference to radio communications. However, there is no guarantee that interference will not occur in a particular installation. If this equipment does cause harmful interference to radio or television reception, which can be determined by turning the equipment off and on, the user is encouraged to try to correct the interference by one or more of the following measures:

- Reorient or relocate the receiving antenna.
- Increase the separation between the equipment and receiver.
- Connect the equipment into an outlet on a circuit different from that to which the receiver is connected.
- Consult the dealer or an experienced radio/TV technician for help.

Modifications not expressly approved by the manufacturer could void the user's authority to operate the equipment under FCC rules.

13 Guarantee

This product is guaranteed for a period of two years against faults in materials or workmanship. The guarantee can be extended three years by registering the product at www.genelec.com. Refer to your supplier for full sales and guarantee terms in your region.