

Frontplattenausschnitt (Rückseite)  
Panel cut out (rear side)

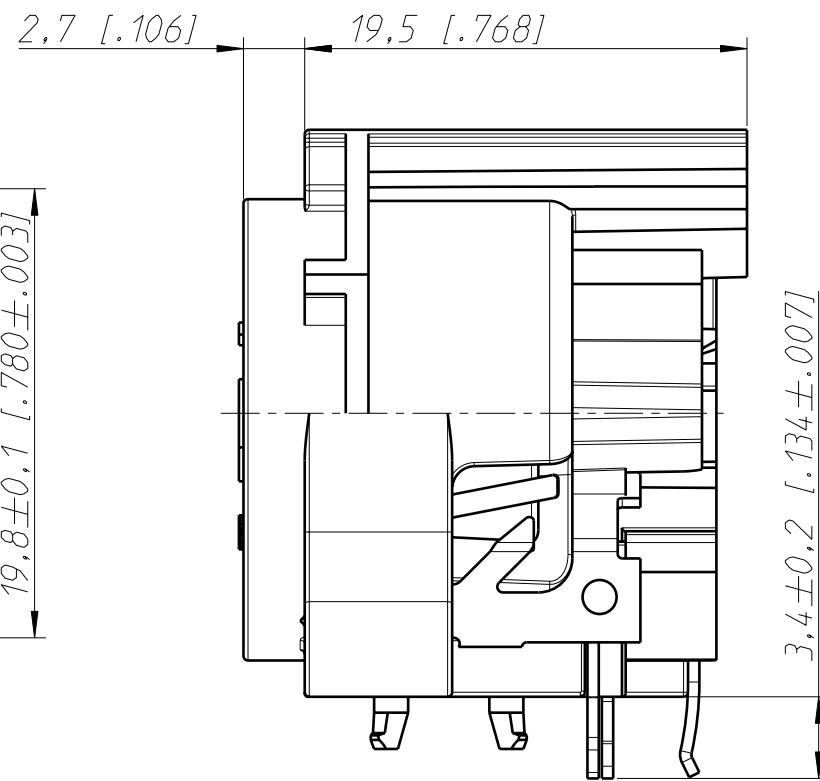

Print-Bohrplan (Bestückungsseite)  
PCB-Layout (component side)

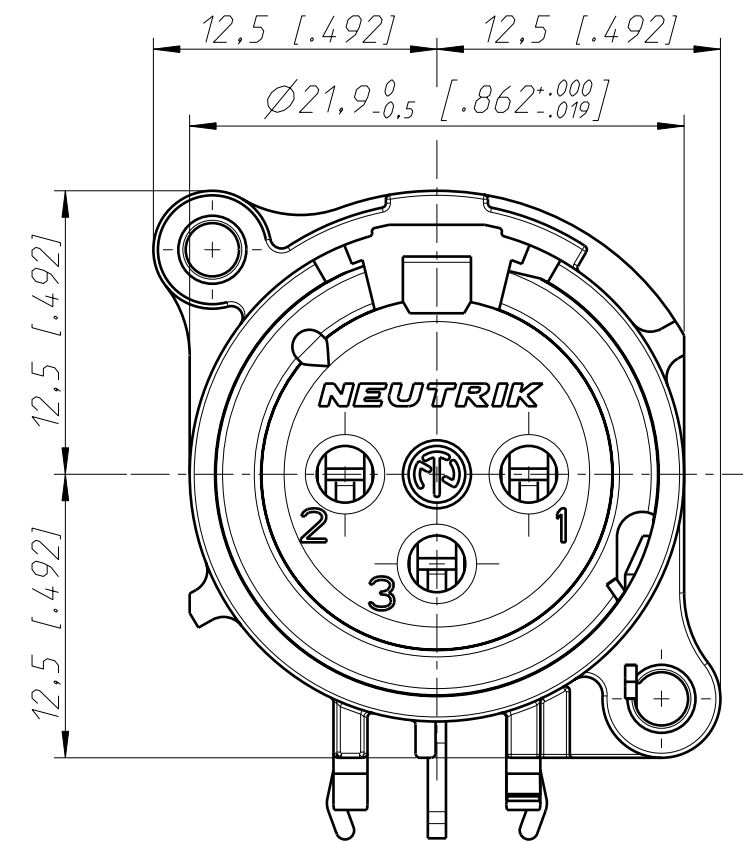

min. Einbauabstand  
min assembling distance

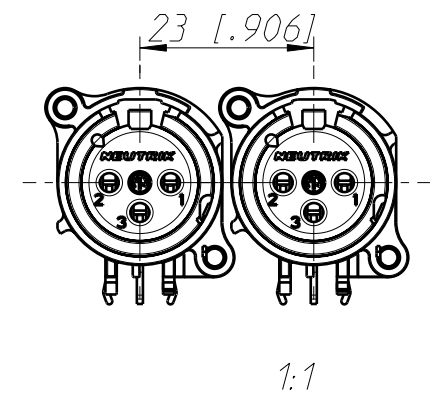
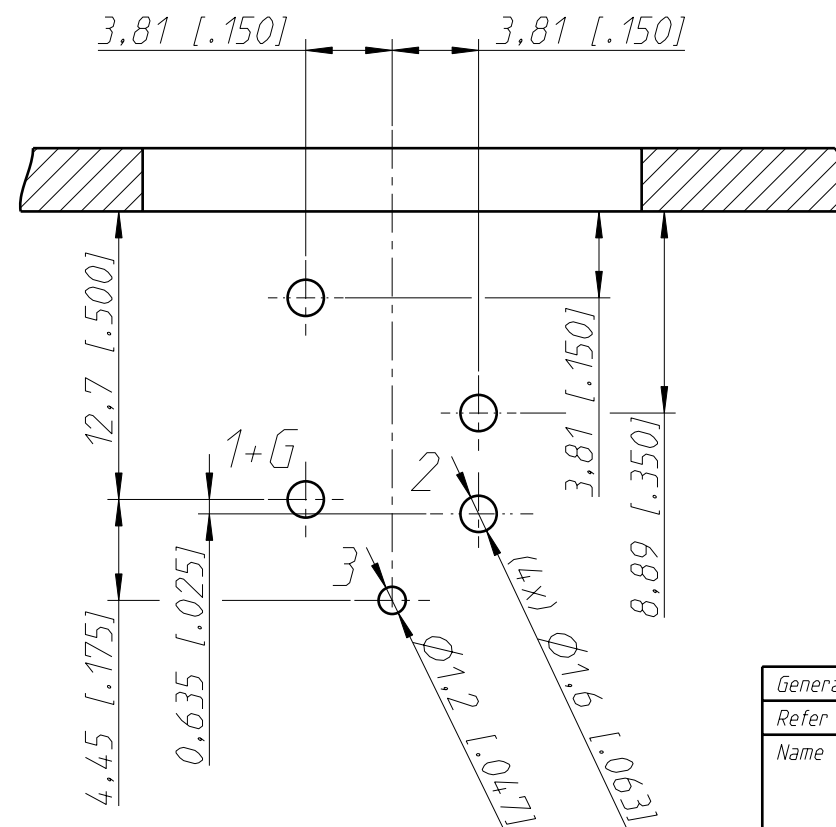
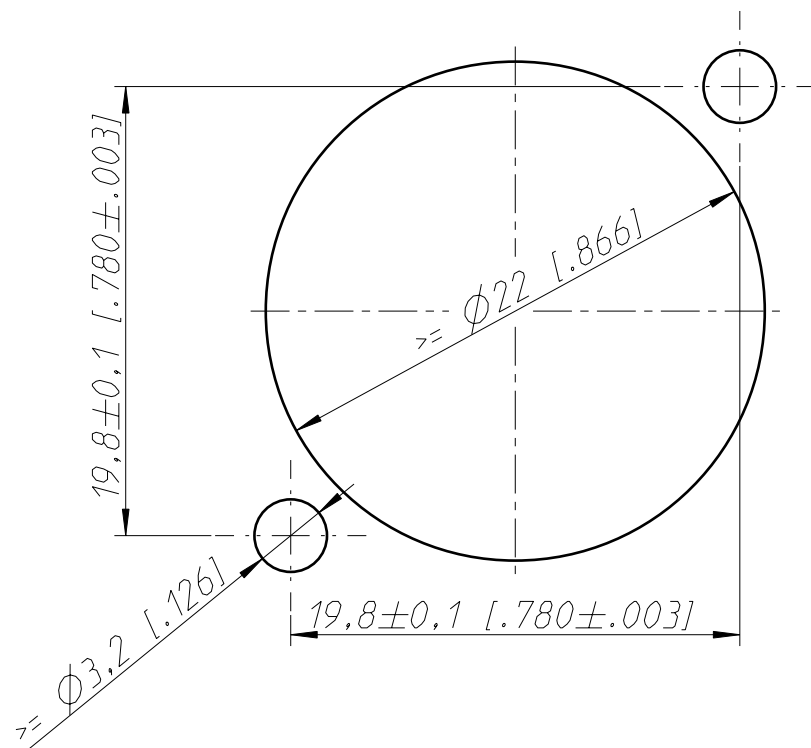

General tolerances ISO 2768-m	Scale	Date	Name
Refer to protection notice ISO 16016.	3:1 (A3)	27.11.02	Dobler
Name	NC3FAAH1-0	Modified	07.03.19
	NC3FAAH1-0	Change-No.	2018-0140
		Sheet-No.	1 / 1
		Index	B
Replacement for:		Drawing-No.	
NEUTRIK		ST-NC3FAAH1-0	