

Frontplattenausschnitt (Rueckseite)
Panel cut out (rear side)

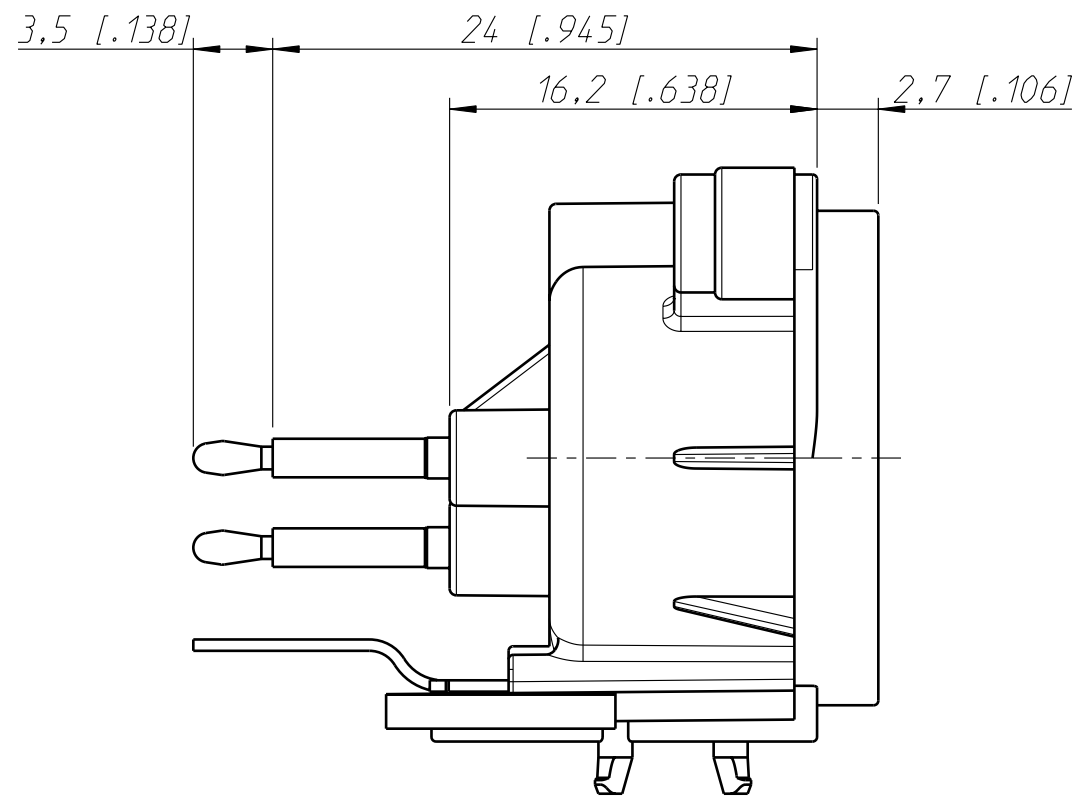

Print Bohrplan (Bestueckungsseite)
PCB-Layout (component side)

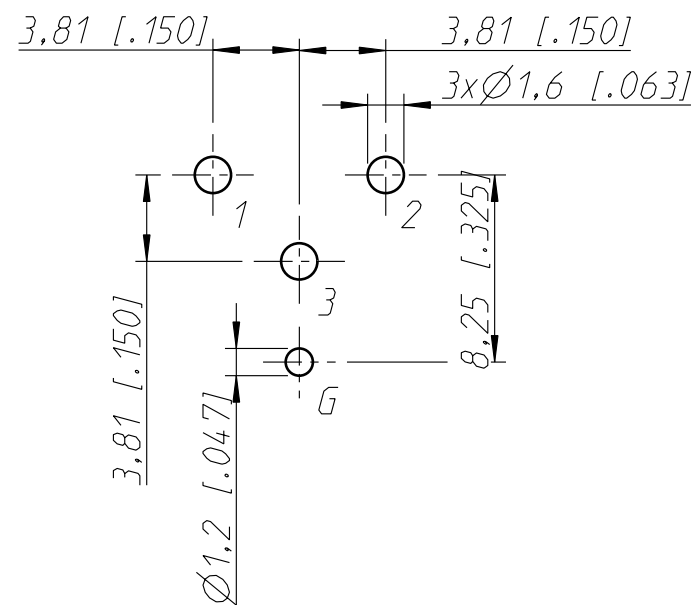
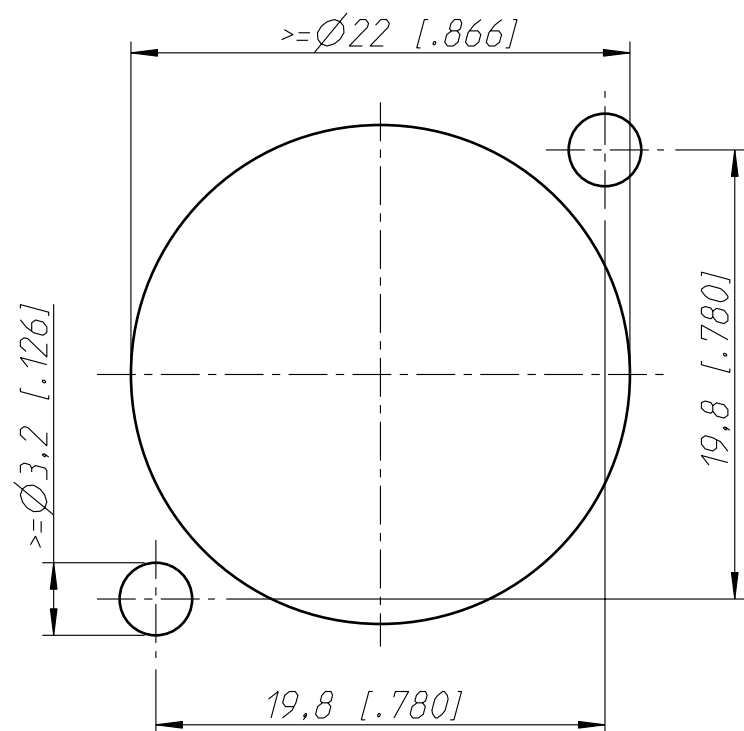
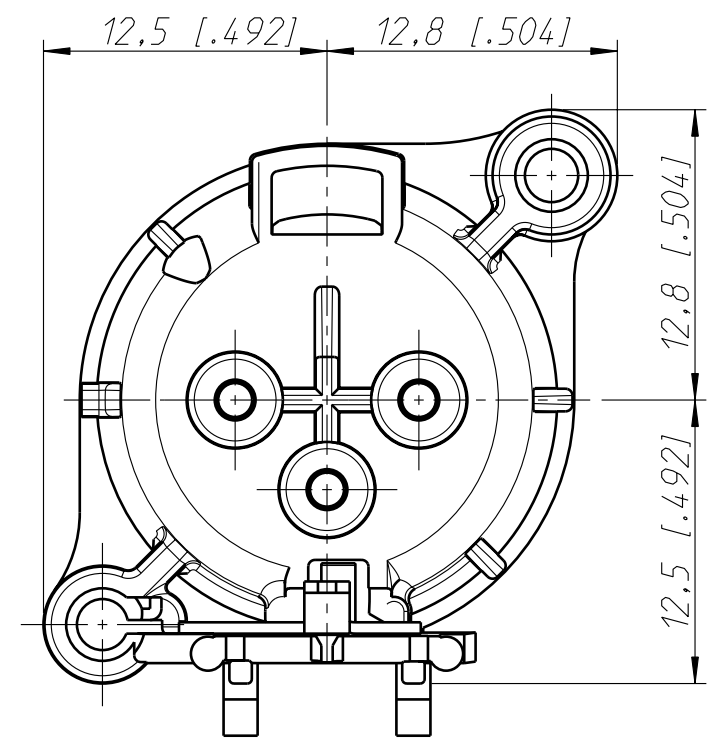

Allgemeintoleranzen ISO 2768-m	Werkstoff -	Massstab: 3:1 (A3)	Gezeichnet	Datum	Name
			Freigegeben	21.06.04	Payr
Zeichnung urheberrechtlich geschuetzt (DIN 34) (C)	-	-	Geaendert	30.03.09	Mijatovic
			Aend.-Nr.	-	Aend.-Index A
Benennung XLR Chassis Connectors NC3MAAV-0			Ersatz fuer:	Blatt 1 von 1 Bl.	
NEUTRIK AG FL-9494 SCHAAN			Zeichn. Nr.	ST-NC3MAAV-0	