



# S2 Digital I/O Analogue Radio Broadcast Mixer **User Handbook**



**SONIFEX**



For the latest Sonifex handbook information please visit the Sonifex website at [www.sonifex.co.uk](http://www.sonifex.co.uk)



**Revision 2.21 February 2020**

**©Sonifex Ltd, 2000-2020**

**All Rights Reserved**

**Sonifex Ltd, 61, Station Road, Irthlingborough,  
Northants, NN9 5QE, England.**

**Tel : +44 (0)1933 650 700**

**Fax : +44 (0)1933 650 726**

**Email : [sales@sonifex.co.uk](mailto:sales@sonifex.co.uk) or [technical.support@sonifex.co.uk](mailto:technical.support@sonifex.co.uk)**

**Web : <http://www.sonifex.co.uk>**

Information in this document is subject to change without notice and does not represent a commitment on the part of Sonifex Ltd. Sonifex Ltd shall not be liable for any loss or damage whatsoever arising from the use of information or any error contained in this manual.

No part of this manual may be reproduced or transmitted in any form or by any means, electronic or mechanical, including photocopying, recording, or information storage and retrieval systems, for any purpose other than the purchaser's personal use, without the express written permission of Sonifex Ltd.

Unless otherwise noted, all names of companies, products and persons contained herein are part of a completely fictitious adaptation and are designed solely to document the use of Sonifex products.



<b>Warranty &amp; Safety Information</b>	<b>i</b>
Warranty and Liability	i
Returning the Warranty Card	iii
Unpacking the S2	iii
Safety of Mains Operated Equipment	iv
Fuse Rating	iv
Power Cable and Connection	iv
WEEE & RoHS Directives - Sonifex Statement	v
Reporting Faults	vi
<b>1 Introduction</b>	<b>1</b>
Innovative Design	1
Superb Audio Quality and Unquestionable Reliability	3
Features	3
<b>2 Installation Notes</b>	<b>4</b>
Atmosphere	4
Electromagnetic Radiation	4
Dimensions and Cut-Out Sizes	4
Channel Configuration	5
Connectors and Cabling	5
System Block Diagrams	9
Applications	11
Removing & Replacing Channels	13
Connecting A Split Desk	14
<b>3 Power Supply</b>	<b>16</b>
S2-PSU Power Supply (Old Version)	16
Front Panel	16
Rear Panel	17
Safety of Mains Operated Equipment	17
Ordering the Correct Mains Lead	18
Power Cable and Connection	18
Fuse Rating	18
S2-PSU Power Supply (New Version)	19
Front Panel Indicators	21
Rear Panel	22
<b>4 Input Channels</b>	<b>25</b>
S2-CML Mic/Line Input Channel	25
S2-CMM Mic/Mic Input Channel	25
S2-CS Dual Stereo Line Input Channel	25
S2-CSE Dual Stereo Line Input with EQ Channel	26
S2-CSG Stereo Line with Gram Input Channel	26
S2-CDS Digital Dual Stereo Input Channel	26
S2-CDSE Digital Dual Stereo Input with EQ Channel	26
S2-C6SS 6 Way Stereo Line Source Select Channel	26
S2-CT Telco Input Channel	26
S2-CSMM Stereo Mix-Minus Channel	27
S2-PG S2 Penny & Giles Conductive Plastic Fader	27
<b>5 S2-CML Mic/Line Channel With EQ</b>	<b>28</b>
Panel Controls	28
Rear Panel	29
Channel Options, Jumper Settings and Presets	30



# CONTENTS



## CONTENTS

<b>6 S2-CMM Mic/Mic Channel With EQ</b>	<b>36</b>
Panel Controls	36
Rear Panel	37
Channel Options, Jumper Settings and Presets	38
<b>7 S2-CSE/S2-CS Dual Stereo Line Channel With &amp; Without EQ</b>	<b>43</b>
Panel Controls	43
Rear Panel	44
Channel Options, Jumper Settings and Presets	45
<b>8 S2-CSGE/S2-CSG Stereo Line And Gram Channel With &amp; Without EQ</b>	<b>52</b>
Panel Controls	52
Rear Panel	53
Channel Options, Jumper Settings and Presets	54
<b>9 S2-CDSE/S2-CDS Digital Dual Stereo Line Channel With &amp; Without EQ</b>	<b>61</b>
Panel Controls	61
Rear Panel	62
Channel Options, Jumper Settings and Presets	63
<b>10 S2-C6SS 6 Way Stereo Line Source Select Channel With EQ</b>	<b>70</b>
Panel Controls	70
Channel Options, Jumper Settings and Presets	72
<b>11 S2-CT Telco Channel With EQ</b>	<b>76</b>
Panel Controls	76
Rear Panel	77
Channel Options, Jumper Settings and Presets	78
<b>12 S2 CSMM Stereo Mix Minus Channel With EQ</b>	<b>83</b>
Panel Controls	83
Rear Panel	84
Channel Options, Jumper Settings and Presets	85
<b>13 Output Channels</b>	<b>92</b>
S2-ODP Digital PGM Output Channel & S2-ODPF Digital PGM Output Channel With Master Fader	92
S2-ODA Digital AUD Output Channel & S2-ODAF Digital AUD Output Channel With Master Fader	92
S2-OMC Control Room Monitor Channel	92
S2-OMS Studio Monitor Channel	93
<b>14 S2-ODPF/S2-ODP Digital Output PGM Channel With &amp; Without Master Fader (Version 1)</b>	<b>94</b>
Panel Controls	94
Rear Panel	95
Channel Options, Jumper Settings and Presets	96
<b>15 S2-ODPF/S2-ODP Digital Output PGM Channel With &amp; Without Master Fader (Version 2)</b>	<b>101</b>
Panel Controls	101
Rear Panel	102
Channel Options, Jumper Settings and Presets	103



<b>16 S2-ODAF/S2-ODA Digital Output AUD Channel With &amp; Without Master Fader (Version 1)</b>	<b>108</b>
Panel Controls	108
Rear Panel	109
Channel Options, Jumper Settings and Presets	110
<b>17 S2-ODAF/S2-ODA Digital Output AUD Channel With &amp; Without Master Fader (Version 2)</b>	<b>115</b>
Panel Controls	115
Rear Panel	115
Channel Options, Jumper Settings and Presets	117
<b>18 S2-OMC Control Room Monitor Channel</b>	<b>122</b>
Panel Controls	122
Rear Panel	123
Channel Options and Jumper Settings	124
<b>19 S2-OMS Studio Monitor Channel</b>	<b>128</b>
Panel Controls	128
Rear Panel	129
Channel Options and Jumper Settings	130
<b>20 Meterbridge Modules</b>	<b>134</b>
Meterbridge Module Types	134
Meterbridge Distribution Board	135
S2-MB1-5 Meterbridge Blanking Plates	136
S2-ML Meterbridge Loudspeaker Monitor Panel	136
S2-MVU Meterbridge VU Meter Panel, S2-MPPM PPM Meter Panel & S2-ML53 LED Meter Panel	137
S2-MPH Meterbridge Phase Meter Panel	139
S2-MTB6 Meterbridge 6 Way Talkback Panel	140
S2-MTBS Meterbridge Station Master Talkback Panel	141
S2-MSB1 Meterbridge Switch Panel With 1 Button	145
S2-MSB3 Meterbridge Switch Panel With 3 Buttons	145
S2-MT Meterbridge Timer Panel	146
Overview	146
Panel Controls	146
Rear Panel	147
Configuring The Timer	147
<b>21 Technical Specifications</b>	<b>152</b>
S2 Mixer Weights and Boxed Dimensions	154
<b>Glossary</b>	<b>155</b>





### Figures

Fig 1-1 :	S2-15 Chassis Complete with Channels.	1	Fig 12-1 :	S2 Stereo Mix-Minus Board Layout.	86
Fig 1-2 :	S2-7SS Script Space.	2	Fig 14-1 :	S2 Digital PGM Output Board Layout.	97
Fig 2-1 :	Mixer Profile.	4	Fig 14-2 :	S2 Digital PGM Output With Fader Board Layout.	98
Fig 2-2 :	Mixer Cut-Out Details.	5	Fig 15-1 :	S2 Digital PGM Output Board Layout.	105
Fig 2-3 :	XLR Connectors.	6	Fig 15-2 :	S2 Digital PGM Output With Fader Board Layout.	105
Fig 2-4 :	RCA Phono Connector.	6	Fig 16-1 :	S2 Digital AUD Output Board Layout.	111
Fig 2-5 :	BNC Connector.	6	Fig 16-2 :	S2 Digital AUD Output With Fader Board Layout.	112
Fig 2-6 :	1/4" Jack Connectors.	7	Fig 17-1 :	S2 Digital AUD Output Board Layout.	118
Fig 2-7 :	9 Pin & 15 Pin D-Type Connectors.	7	Fig 17-2 :	S2 Digital AUD Output With Fader Board Layout.	118
Fig 2-8 :	25 Pin D-Type Connectors.	8	Fig 18-1 :	Control Room Monitor Board Layout.	124
Fig 2-9 :	9 Pin D-Type Power Connectors.8		Fig 19-1 :	Studio Monitor Board Layout.	130
Fig 2-10 :	System Block Diagram (Sheet 1).	9	Fig 20-1 :	Meterbridge Distribution Board Layout.	135
Fig 2-11 :	System Block Diagram (Sheet 2).	10	Fig 20-2 :	Blanking Plate.	136
Fig 2-12 :	Using the Sonifex RB-LC3 to control an On-Air Light.	11	Fig 20-3 :	Loudspeaker Monitor Panel.	136
Fig 2-13 :	Mixer Bus Cable Slots.	14	Fig 20-4 :	PPM & True PPM Meter Panel.	137
Fig 2-14 :	Mixer Bus Cable Screen Connection.	14	Fig 20-5 :	VU Meter Panel.	137
Fig 2-15 :	Cable & Channel Connection.	15	Fig 20-6 :	VU & PPM LED Meter Panel.	138
Fig 2-16 :	Meterbridge Interconnection.	15	Fig 20-7 :	Phase Meter Panel.	139
Fig 3-1 :	S2-PSU Front Panel.	16	Fig 20-8 :	Meterbridge 6 Way Talkback Panel.	140
Fig 3-2 :	S2-PSU Rear Panel.	16	Fig 20-9 :	Meterbridge Station Master Talkback Panel.	141
Fig 3-3 :	New S2-PSU Front Panel.	19	Fig 20-10a :	S2-M6SS Panel.	143
Fig 3-4 :	New S2-PSU Rear Panel.	20	Fig 20-10b :	S2-M6SS Diagram.	144
Fig 3-5 :	S2-PSUS Front Panel.	21	Fig 20-11a :	S2-MSB1 S2 Meterbridge Switch Panel With 1 Button.	145
Fig 3-6 :	S2-PSUS Rear Panel.	22	Fig 20-11b :	S2-MSB1 Diagram.	145
Fig 3-7 :	New S2-PSU Diagram.	24	Fig 20-12a :	S2-MSB3 S2 Meterbridge Switch Panel With 3 Buttons.	145
Fig 5-1 :	S2 Mic/Line Input Board Layout.	32	Fig 20-12b :	S2-MSB3 Diagram.	145
Fig 6-1 :	S2 Mic/Mic Input Board Layout.	40	Fig 20-13 :	Meterbridge Timer Panel.	146
Fig 7-1 :	S2 Dual Stereo Input With & Without EQ Board Layout.	46			
Fig 8-1 :	S2 Stereo Line & Gram With & Without EQ Board Layout.	55			
Fig 9-1 :	S2 Digital Dual Stereo Input Board Layout.	64			
Fig 10-1 :	S2 6 Way Source Selector Board Layout.	73			
Fig 11-1 :	S2 Telco Input Board Layout.	79			

## Warranty & Safety Information

### Warranty and Liability

**Important: the purchaser is advised to read this clause**

- (a) The Company agrees to repair or (at its discretion) replace Goods which are found to be defective (fair wear and tear excepted) and which are returned to the Company within 12 months of the date of despatch provided that each of the following are satisfied:
- (i) notification of any defect is given to the Company immediately upon its becoming apparent to the Purchaser;
  - (ii) the Goods have only been operated under normal operating conditions and have only been subject to normal use (and in particular the Goods must have been correctly connected and must not have been subject to high voltage or to ionising radiation and must not have been used contrary to the Company's technical recommendations);
  - (iii) the Goods are returned to the Company's premises at the Purchaser's expense;
  - (iv) any Goods or parts of Goods replaced shall become the property of the Company;
  - (v) no work whatsoever (other than normal and proper maintenance) has been carried out to the Goods or any part of the Goods without the Company's prior written consent;
  - (vi) the defect has not arisen from a design made, furnished or specified by the Purchaser;
  - (vii) the Goods have been assembled or incorporated into other goods only in accordance with any instructions issued by the Company;
  - (viii) the defect has not arisen from a design modified by the Purchaser;
  - (ix) the defect has not arisen from an item manufactured by a person other than the Company. In respect of any item manufactured by a person other than the Company, the Purchaser shall only be entitled to the benefit of any warranty or guarantee provided by such manufacturer to the Company.





- (b) In respect of computer software supplied by the Company the Company does not warrant that the use of the software will be uninterrupted or error free.
- (c) The Company accepts liability:
  - (i) for death or personal injury to the extent that it results from the negligence of the Company, its employees (whilst in the course of their employment) or its agents (in the course of the agency);
  - (ii) for any breach by the Company of any statutory undertaking as to title, quiet possession and freedom from encumbrance.
- (d) Subject to conditions (a) and (c) from the time of despatch of the Goods from the Company's premises the Purchaser shall be responsible for any defect in the Goods or loss, damage, nuisance or interference whatsoever consequential economic or otherwise or wastage of material resulting from or caused by or to the Goods. In particular the Company shall not be liable for any loss of profits or other economic losses. The Company accordingly excludes all liability for the same.
- (e) At the request and expense of the Purchaser the Company will test the Goods to ascertain performance levels and provide a report of the results of that test. The report will be accurate at the time of the test, to the best of the belief and knowledge of the Company, and the Company accepts no liability in respect of its accuracy beyond that set out in Condition (a).
- (f) Subject to Condition (e) no representation, condition, warranty or other term, express or implied (by statute or otherwise) is given by the Company that the Goods are of any particular quality or standard or will enable the Purchaser to attain any particular performance or result, or will be suitable for any particular purpose or use under specific conditions or will provide any particular capacity, notwithstanding that the requirement for such performance, result or capacity or that such particular purpose or conditions may have been known (or ought to have been known) to the Company, its employees or agents.
- (g)
  - (i) To the extent that the Company is held legally liable to the Purchaser for any single breach of contract, tort, representation or other act or default, the Company's liability for the same shall not exceed the Price of the Goods.
  - (ii) The restriction of liability in Condition (g)(i) shall not apply to any liability accepted by the Seller in Condition (c).
- (h) Where the Goods are sold under a consumer transaction (as defined by the Consumer Transactions (Restrictions on Statements) Order 1976) the statutory rights of the Purchaser are not affected by these Conditions of Sale.



### Returning the Warranty Card

In order to register the date of purchase so that we can keep you informed of any design improvements or modifications, it is important to complete the warranty registration document that is enclosed and return it to Sonifex Ltd in the UK, or register online at [www.sonifex.co.uk/register](http://www.sonifex.co.uk/register)

For your own records you should write down the serial number of both the power supply and the mixer chassis (2 for a split desk).

1st Mixer Serial Number	
2nd Mixer Serial Number (split desk only)	
Power Supply Serial Number	

### Unpacking the S2

Each product is shipped in protective packaging and should be inspected for damage before use. Where an item is found to have transit damage, notify your supplier immediately with all the relevant details of the shipment. Packing materials should be kept for inspection and also for if the product needs to be returned.





### Safety of Mains Operated Equipment



This equipment has been designed to meet the safety regulations currently advised in the country of purchase and it conforms to the safety regulations specified by use of the CE Mark.

The power supply is rated to 95 - 265VAC at 47 – 63Hz with a fuse of 2A.

**Warning: There are no user serviceable parts inside the machine. If you should ever need to look inside the unit, always disconnect the mains supply before removing the equipment covers.**

### Fuse Rating

The product is supplied with a single fuse in the live conducting path of the power-in feed at the power supply. For reasons of safety it is important that the correct rating and type of fuse is used. Incorrectly rated fuses could present a possible fire hazard, under equipment fault conditions.

### Power Cable and Connection

An IEC power connector is supplied with the product, which has a moulded plug attached – this is a legal requirement. If no moulded plug has been supplied with your product, please contact your supplier, because an IEC connector is always supplied from the Sonifex factory.

If for any reason, you need to use the product with a different power cable, you should use the following wiring guidelines

Wire Colour	Connection
Green, or green and yellow	Earth (E)
Blue, or Black	Neutral (N)
Brown, or Red	Live (L)

## WEEE & RoHS Directives - Sonifex Statement



The Waste Electrical and Electronic Equipment (WEEE) Directive was agreed on 13 February 2003, along with the related Directive 2002/95/EC on Restrictions of the use of certain Hazardous Substances in electrical and electronic equipment (RoHS).

The Waste Electrical and Electronic Equipment Directive (WEEE) aims to minimise the impacts of electrical and electronic equipment on the environment during their life times and when they become waste. It applies to a huge spectrum of products. It encourages and sets criteria for the collection, treatment, recycling and recovery of waste electrical and electronic equipment. All products manufactured by Sonifex Ltd have the WEEE directive label placed on the case. It gives a contact for individuals who are unsure about the correct procedure when the product has reached its “end of use”.

Sonifex Ltd will be happy to give you information about local organisations that can reprocess the products, or alternatively all products that have reached “end of use” can be returned to Sonifex and will be reprocessed correctly free of charge.

Sonifex Ltd has phased out the use of certain hazardous substances identified in the European Union’s Restriction of Hazardous Substances (RoHS) directive. The RoHS directive limits the use of certain hazardous substances currently used in EEE manufacture, including lead, mercury, cadmium, hexavalent chromium, and halide-containing compounds PBB (polybrominated biphenyl) and PBDE (polybrominated diphenyl ether). Elimination of these substances will result in more environmentally friendly recycling of electronic equipment. For the products which Sonifex manufacture, the main area where products were affected was in the use of lead for manufacturing and assembling electronics circuit boards.

Sonifex Ltd practices lead-free (LF) manufacturing processes. LF solder is used on the surface-mount PCB manufacturing processes and for hand soldering. The printed circuit boards (PCBs) used are either gold plated, or immersion tin plated, both of which use no lead. Historically the PCBs were hot air solder levelled (HASL) PCBs which used tin/lead based solder.

The manufacturing processes include the assembly of purchased components from various sources. Product is offered as RoHS compliant, or LF, only after sufficient evidence is received from the component manufacturers that their components are RoHS compliant. Sonifex Ltd relies solely on the distributor, or manufacturer, of the components for identification of RoHS compliance. Thus whilst every effort is made to ensure compliance, Sonifex Ltd makes no warranty, or certification, or declaration of compliance concerning said components.

Sonifex Ltd defines “Lead Free” as pertaining to any product, which has been manufactured by Sonifex Ltd using components which have been declared by the manufacturers as “Lead Free”. All statements by Sonifex Ltd of RoHS compliance are based on component manufacturer documentation.



# REPORTING A FAULT



REPORTING A FAULT

## Reporting Faults

Although this Sonifex product is manufactured to the highest standards, it is possible that minor faults may appear in the equipment over its normal lifetime. If you find any problems with the product, please contact your Sonifex distributor, or contact Sonifex directly at the following address, or fax with a copy of this completed sheet :

To :	From:
Sonifex Ltd,	Name
61, Station Road,	Position
Irthlingborough,	Company
Northants.	Address
NN9 5QE, UK	
Tel : +44 (0)1933 650 700	Tel
Fax : +44 (0)1933 650 726	Fax
Email : technical.support@sonifex.co.uk	Email

For the Serial No. of your machine, see the back panel of the unit.

**Serial No.**

Please describe the error in as much detail as possible (for example what you were doing when the problem occurred, what actually happened, etc)

**Description of Error**

Also, if you have any suggestions for additions or upgrades to the unit , we would like to hear what they are :

**Additions that I Would Like to See**

## 1 Introduction

S2 is a new breed of radio broadcast mixer. Using the latest technology components, S2 offers digital audio quality with analogue reliability in a modular format. S2 has both digital and analogue input channels, together with simultaneous analogue and digital outputs.

Following on from the Sovereign range of audio mixers, S2 combines all the features needed of a radio broadcast mixer in a stylish, flush-mounting chassis: a wide range of input and output channels, PFL/Cue, fader-start operation of equipment, automatic monitor muting on mic-live, light switching remote outputs, optional EQ on input modules, gram amp input options and 2 main audio buses, allowing you to broadcast on the PGM bus while recording on the AUD bus, with bus output selection on each module.



INTRODUCTION



Fig 1-1 : S2-15 Chassis Complete with Channels.

### Innovative Design

- The S2 chassis is available in 5 channel width sections, allowing 5, 10, 15, 20, 25 and 30 channel width mixers. This means S2 can be used for small newsrooms or large on-air situations. The following table shows the model number along with the total channel width.

Model No.	Number of Channels
S-05	5
S-10	10
S-15	15

Model No.	Number of Channels
S-20	20
S-25	25
S-30	30



- The Script Space (S2-7SS) occupies an area of 7 channel widths, and is designed to hold documents/scripts for the mixer operator when desk space is at a premium. It is most commonly placed in the centre of the mixer, although it can be positioned anywhere within the mixer chassis. It has a hole in the rear of the front section to allow a keyboard/mouse cable to pass through and a 10 channel Script Space (S2-10SS), is also available.

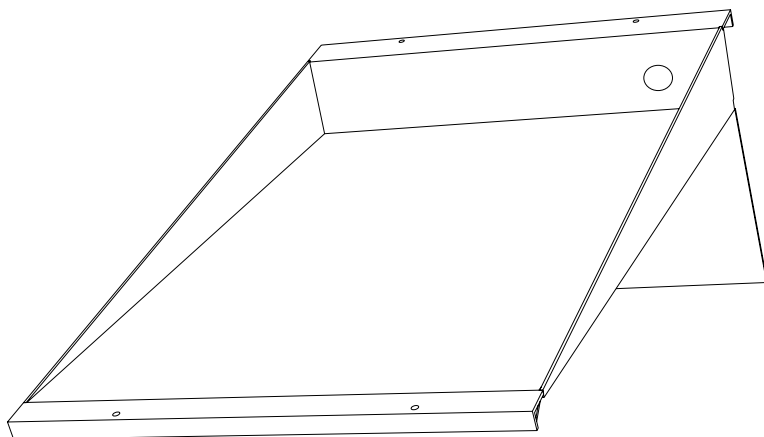

Fig 1-2 : S2-7SS Script Space.

- Blank channels (S2-CB) can be used to fill spaces in the chassis not occupied by active channels.
- Modular “pop-up” input and output channels means that the mixer can be maintained simply and quickly. Input channels can be individually removed and repaired whilst still on-air.
- The angle of the meterbridge can be varied and set for best viewing position.
- Any channel can be in any position so that customizing the mixer for your own purposes is easy.
- Large backlit buttons allow you to see the status of the mixer at all times.
- The fitted rear panel hides all cable connections but can be simply removed for maintenance.
- The modular design of the desk gives you the flexibility to expand it at a later date. You can even add another S2 mixer and link them together with a bus connector cable to allow for split desk configurations.

## Superb Audio Quality and Unquestionable Reliability

- The S2 uses the latest Crystal semiconductor technology to allow input and output of digital audio signals up to 24 bit, 96kHz sample rate.
- The analogue signal paths use low noise circuitry to provide superb audio performance well capable of satisfying radio listeners worldwide.
- The high reliability and build quality of S2 minimizes the chance of failure, avoiding lost air-time. Each channel is individually checked twice before being assembled into the finished chassis and the whole unit is tested before shipping.
- ALPS long throw 100mm faders give a smooth, repeatable response and the Neutrik XLR connectors used are an industry standard.
- The use of VCAs controlled by the faders ensures tight stereo tracking and eliminates mechanical and electronic noise.
- S2 has a separate 1U power supply providing regulated, ripple-free power to the mixer.
- High quality stainless steel is used for the chassis and screws to prevent corrosion in high humidity environments.



## Features

- Fully modular build with six different frame sizes available.
- Optional script space.
- Digital and analogue inputs.
- Digital and analogue PGM and AUD outputs as standard.
- Mono analogue output.
- True cleanfeed output on each telco input.
- Stereo cleanfeed channel available.
- VCA faders.
- VU and PPM metering.
- Optional master faders on outputs for production use.
- Dual digital timers with real time clock.
- Separate control room and studio monitor channels.
- Optional RIAA inputs for dual stereo channel.



## 2 Installation Notes

### Atmosphere

The S2 mixer should be installed in an area which is not subject to excessive heat or cold. Also, you should avoid installing it in atmospheric conditions which are dusty, smoky, or dirty, or where there is moisture or vibration.

Do not use any liquids to clean the fascia of the mixer: a soft dry brush is ideal. Use a clean cloth moistened with water or ethyl alcohol to clean the trim and scribe pads. Other solvents may cause damage to paint or plastic parts.

### Electromagnetic Radiation

Avoid using the S2 mixer close to strong sources of electromagnetic radiation such as, video monitors or high power electric cabling. This may cause degradation of the audio quality due to induced voltages in connecting leads and chassis. The S2 power supply should also be sited at least 1 metre from the mixer.

In all cases the S2 mixer and power supply should be installed and serviced by qualified personnel.

### Dimensions and Cut-Out Sizes

The S2 mixer consists of a stainless steel chassis with plastic side and top mouldings and aluminium front trim. The dimensions for the mixer below include the mouldings and trim. The cut-out size is for reference only and should be checked with your mixer.

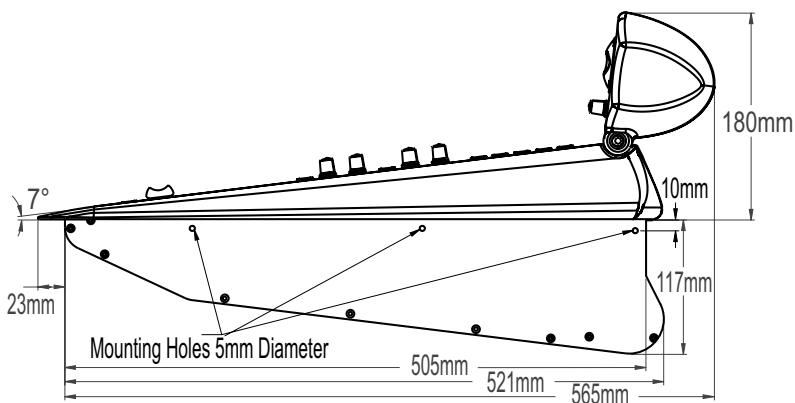

Fig 2-1 : Mixer Profile.



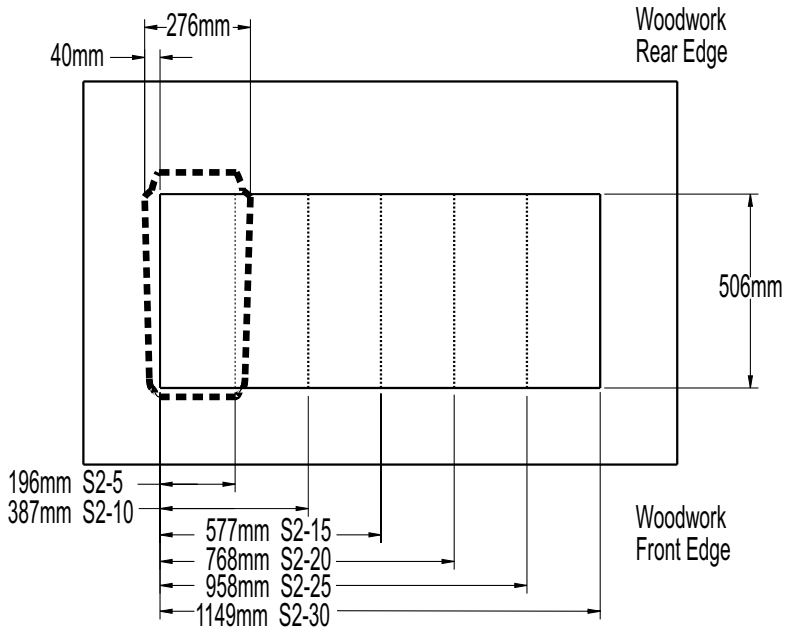

Fig 2-2 : Mixer Cut-Out Details.

### Channel Configuration

Each of the channels can be re-configured by jumpers, which are displayed in the “Channel Options and Jumper Settings” section of each chapter. You should ensure that you are thoroughly familiar with the settings available for each channel before attempting installation of the mixer. This is because some options may involve moving jumpers on several channels to change the configuration of the mixer.

### Connectors and Cabling

Many of the problems associated with installing and maintaining a mixing console are due to the use of poor cables or faulty connections. It is recommended that, wherever possible, pre-wired cables are purchased from recommended manufacturers. If you need bespoke cables making, please ensure that a qualified engineer carries out the work.



The main types of connectors used with the S2 mixers are the following:

### XLR 3 Pin Connectors

The following diagram shows the pin details for the 3 pin XLR sockets and plugs:

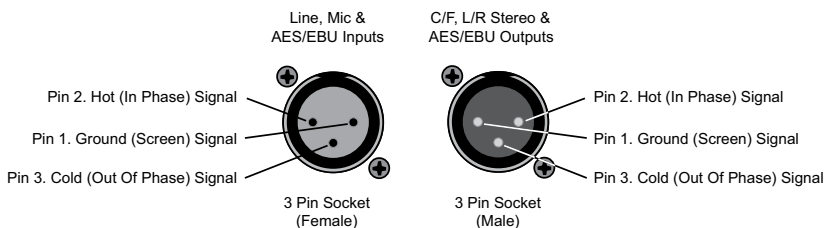

Fig 2-3 : XLR Connectors.

### RCA Phono Connector

This connector is used on the Stereo Gram Channel and the S/PDIF inputs on the digital input/output channels.

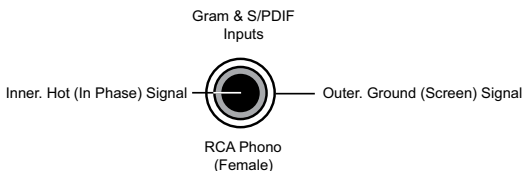

Fig 2-4 : RCA Phono Connector.

### BNC Connector

This connector is used for the Word clock inputs on the PGM and AUD output channels.

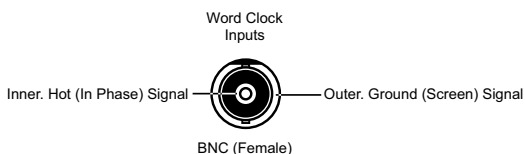

Fig 2-5 : BNC Connector.

### 6.35mm 'A' Gauge Stereo Jack Plugs

'A' Gauge Stereo Jack Plugs can be connected as follows:

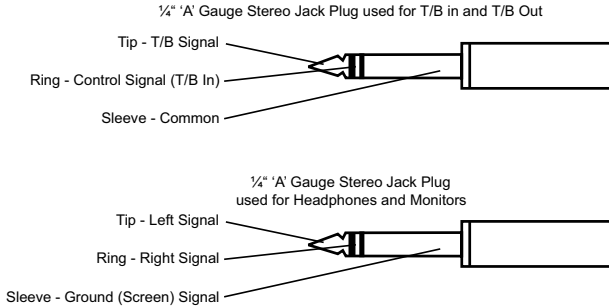

Fig 2-6 : 1/4" Jack Connectors.

### D Type Connectors

Several different D type connectors are used on the S2. A 9 pin plug is used for the remotes on input channels and external inputs on monitor channels. A 15 pin socket is used for the analogue outputs and mute relays on the output channels. A 25 pin socket is used for the audio inputs, and a 25 pin plug for the remotes, on the 6 way stereo select channel. A 9 pin plug & socket is used for the power connections from the PSU to the mixer.

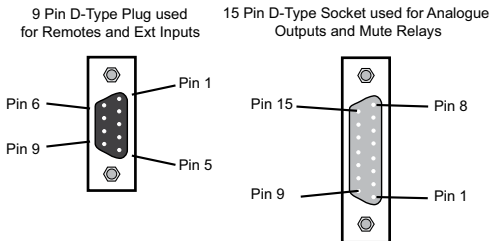
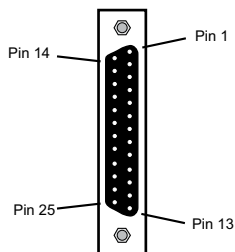

Fig 2-7 : 9 Pin & 15 Pin D-Type Connectors.





25 Pin D-Type Plug  
used for Audio Inputs



25 Pin D-Type Socket  
used for Remotes

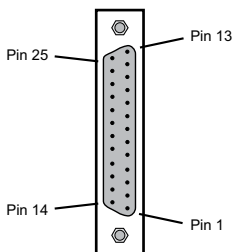
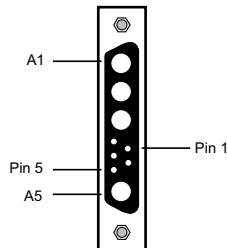

Fig 2-8 : 25 Pin D-Type Connectors.

9 Pin D-Type Plug used  
for Power Connections



9 Pin D-Type Socket used  
for Power Interconnect Cable

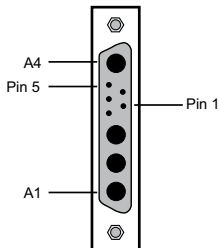
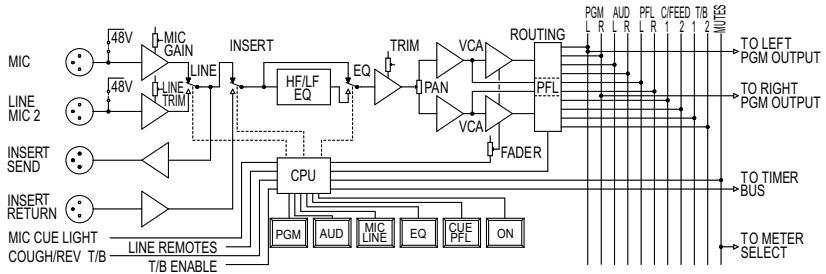

Fig 2-9 : 9 Pin D-Type Power Connectors.

## System Block Diagrams

### Input Channels Diagram - CMM & CML



### Input Channel Diagram - CT Telco

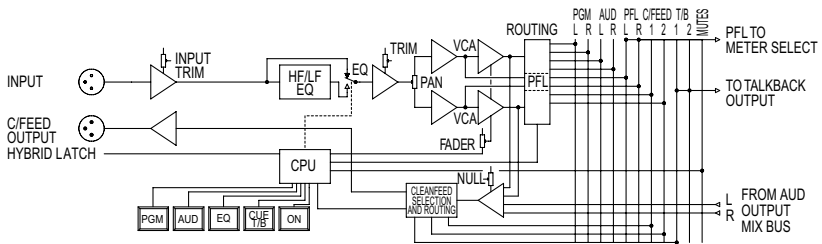

### Input Channels Diagram - CSG,CSGE,CS,CSE,CD,S,CDSE, and CSMM C6SS

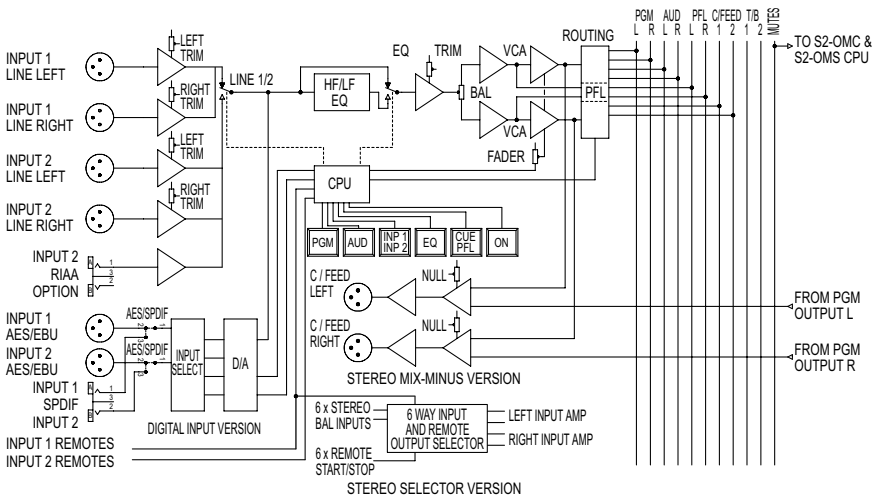
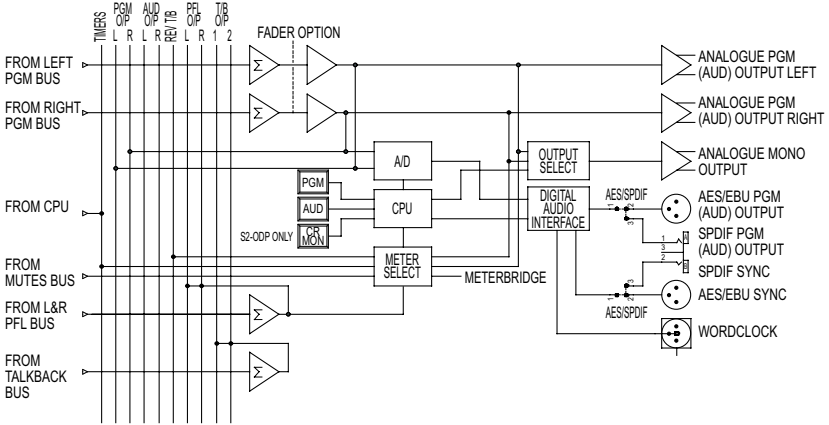

Fig 2-10: System Block Diagram (Sheet 1).





### Output Channels Diagram - ODP,ODPF,ODA, and ODAF



### Output Channels Diagram - OMS and OMC

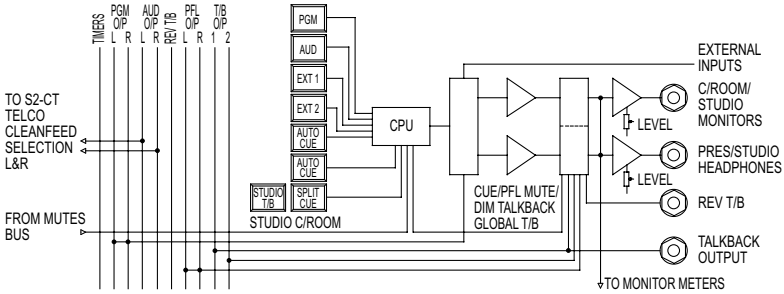

### Meterbridge Diagram - MPPM/T, PPM, MVU, VU, ML53, MPH, MTBS, MTB6, MT, and ML

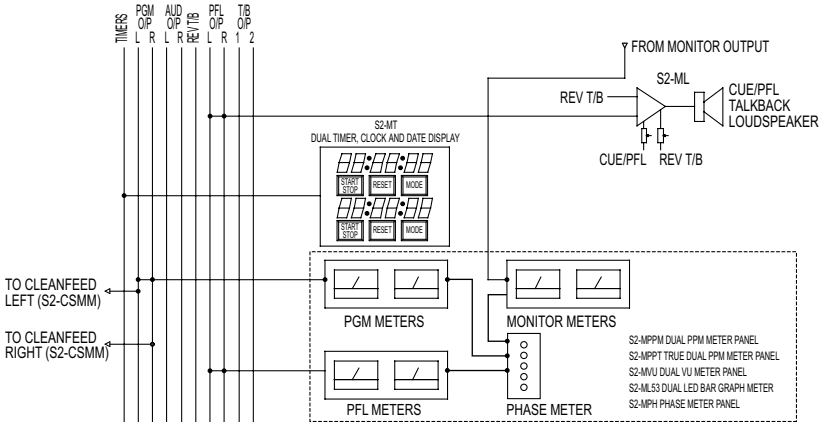

Fig 2-11 : System Block Diagram (Sheet 2).

## Applications

This section of the handbook provides examples of how to configure the different types of modules for typical applications:

### Controlling an On-Air Light Using the Output Modules

The On-Air light, also known as Mic Live, is used to indicate to everyone inside or outside of the Control Room and/or Studio that microphones are live and on-air.

Two sets of latching relay contacts, activated by a control room mute, are available on the 15 way D type socket on the rear panel of the PGM and AUD modules for the Control Room On-Air light and Studio On-Air light respectively. See the Remote Connector pin-outs of the relevant modules for details.

Shown below is an example of connecting one of the latching relay contacts on the PGM or AUD modules to a Sonifex RB-LC3. The remote connection on the RB-LC3 is active low.

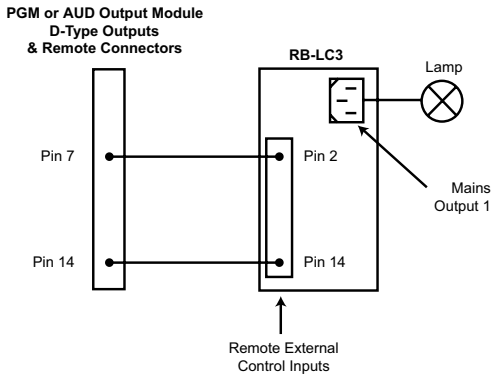

Fig 2-12 : Using the Sonifex RB-LC3 to control an On-Air Light.

### Controlling a Mic Cue Light using the Input Modules

The mic cue light is used to indicate to a guest, etc, situated in a talks studio, that they should speak. The cue light is usually green, and there is usually one per microphone. This should not be confused with a mic live light, which is red and there is one per studio or control room, also known as "On Air light" (see above).

Opto-isolated outputs for a mic cue light are provided on the remote connectors of the Mic/Mic and Mic/Line modules. See the Remote Connector pin-outs of the relevant modules for details.

**NOTE:** It is vital that mains voltages are **NOT** connected to any of the connectors on the mixer. If your On-Air light is to be mains operated then you should use a suitable opto-isolated solid-state mains relay. The Sonifex Redbox RB-LC3 Light/Power controller is a suitable unit that will control up to three On-Air lights and/or Mic cue lights.





### Enabling Talkback On Mic Modules

Talkback is used for off-air communication between studios, or between the Presenter, the Studio guests and callers on the telephone line. The presenter's microphone module can be configured to be the talkback source to the studio guests and telephone callers by connecting pin 9 to pin 7 on the presenters Mic/Mic or Mic/Line modules remote connector. This talkback audio also appears on the talkback output connector on the control room monitor module as a continuous feed. It can be used for routing talkback to other destinations.

### Cough Switch and Talkback On Mic Modules

A cough switch is used to momentarily mute the output of a live microphone channel when you wish to clear your throat. Closing pin 8 to pin 7 on a Mic/Mic or Mic/Line modules remote connector performs the cough function when the module is live, i.e. when the mic input is selected, the channel is routed, the channel is ON and the fader is up. This function can be used for the presenters mic but is more usually only provided for the studio microphones.

The cough switch performs the function of talkback to the presenter when the module is not live. In this case, when a studio guest presses his cough switch the microphone module is put in to PFL, which routes the pre fade mic signal to the control room monitoring where it can be heard by the presenter via his headphones or monitor loudspeakers. The presenter can talk back to the studio by using the Studio T/B button situated on the studio monitor module. For the presenter to hear the talkback from the studio automatically, either or both the control room monitor loudspeakers and the headphones should be set to Auto Cue/PFL. While the Cough switch is enabled, if PGM and/or AUD are enabled then they will flash quickly to indicate that Cough is enabled.

### Using Voice Processors On Mic Channels

The Insert point on Mic input channels is useful for hooking up an outboard effects unit to be used with the microphone, for example, a voice processor. The insert send signal is always available as a line level balanced output. The insert return signal is enabled by placing jumper J10 on the channel, over pins 1 & 2. The insert return function is disabled in Line mode except when jumper J5, Mic on Line Input, is set.

### Remote Start and Stop

When an input module is being used in line mode (e.g a Mic/Line on input 2 or a Dual Stereo module) it is usually necessary to control external equipment by means of the remote start and stop functions. See the relevant modules for pin out details.

If your equipment has a remote facility for "Fader Start" then this normally requires a latching contact to start, opening the contact will cause the equipment to stop. In this case it is only necessary to use the start remote, but you will need to make the contact latching by setting a jumper (See the relevant module for jumper settings).



If your equipment has remote facilities for "Play", "Stop", "Re-Cue", it will be necessary to use both start and stop remotes. In this case you will need a momentary start. It should be noted that pins 2 & 5 on the input modules remote connector is common to start and stop and should be connected to the common pins on your equipments remote connector. Pins 1 & 4 on the remote should be connected to the "Play" pins on your equipment, and pins 3 & 6 should be connected to the "Stop" pins. Sometimes it may be useful to connect the mixer stop remote to the "Re-Cue" pin.

### Adding Telco Channels

When adding a Telco channel to the mixer there are certain requirements that need to be met for the correct operation of the cleanfeed buses. Depending on whether you have 1, 2 or no telco channels fitted, you may have to alter the cleanfeed bus termination on the digital PGM and AUD Output channels. If the console is supplied without Telco channels then both cleanfeed mix buses will need to be terminated. With one Telco channel, only the unused cleanfeed bus will require termination. With two Telco channels no termination is required. Please refer to that section of the handbook for further info.

The jumpers J11 and J12 on the Telco channel determine which of the two true cleanfeed buses the channel uses. There can only be a maximum of two telco channels in each mixer and they must not share a cleanfeed bus. If you have only one telco channel, the jumpers are fitted over pins 1 & 2 of J11, using cleanfeed bus 1. If a second telco channel is present in the mixer, then this second channel will have the jumpers fitted over pins 2 & 3 of J12, using cleanfeed bus 2 only.

### Removing & Replacing Channels

When installing the mixer it may be necessary to change certain characteristics of a channel to suit your specific needs, e.g. jumper settings, internal gain pots, etc. To do this the channel must be removed from the chassis to gain access to the jumpers and pots. Particular care must be taken when performing this procedure.

To remove a channel, first disconnect any attached cables from the rear of the channel, and remove the two screws from the front panel of the channel. The channel should now be lifted slightly from the chassis with the aid of springs situated at the two fixing points, with enough room to grab both ends of the channel, so that you can carefully lift it from the chassis. Be careful not to lay the channel across the mixer, as the underside of the channel PCB may cause scratching.

Once the necessary changes have been made, ensure that the main bus cable is still firmly attached and carefully position the channel directly above the space where it was removed from, holding it at a tilt, so that the fader end of the mixer will make contact with the chassis first. Slowly lower it down into the mixer, making sure that the main bus cable is formed correctly and the slack does not get trapped beneath the channel. Once the fader end has made contact, continue lowering the rear end of the channel down until that also makes contact, ensuring that it is flush with the channels beside it. Replace the screws, and reattach the cables to the rear of the channel.





### Connecting A Split Desk

There are three cables used when connecting an S2 mixer split desk configuration. A 16 way IDC cable which connects the two meterbridge distribution boards, A 60 way jacketed IDC cable which connects the two main mixer bus cables and an earth braid cable which connects the two chassis. When shipped, these three cables will already be attached to one of the mixers and will require attaching to the other mixer. The procedure to do this is described below.

### Connecting The Mixer Bus Interconnect Cable

On the under side of the mixer chassis are two slots at each end. These are where the mixer bus interconnect cable feeds through (Fig 2-13). The first thing to do is to remove the channel from the end of the mixer where the cable is going to be connected. If the interconnect cable is to be connected to the left handside mixer then this will be the right most channel of the mixer. If the interconnect cable is to be connected to the right handside mixer then this will be the left most channel.

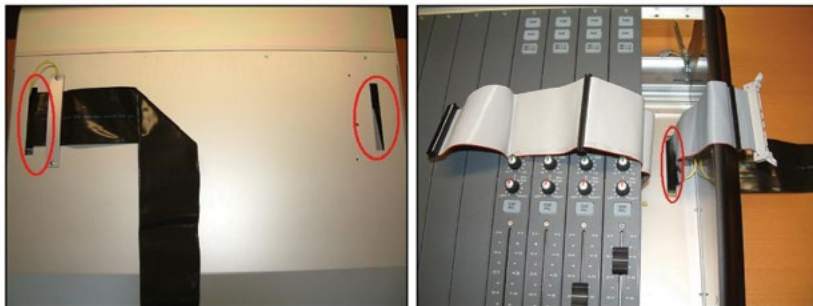

Fig 2-13 : Mixer Bus Cable Slots.



Fig 2-14 : Mixer Bus Cable Screen Connection.

Once the channel has been removed, pull the cable through the slot making sure that the cable has not twisted coming from the first mixer. Pull it through so that about 2 inches (5 cm) of the cable jacketing is inside the chassis. Connect the screening wire to one of the clamping plate screws and screw in the plate to the underside of the chassis to secure the cable, and stop it from moving (Fig 2-14).

Then loop the cable back over itself and connect the 60 way IDC plug to the main mixer bus (Fig 2-15). Now reconnect the channel that was removed, to the free 60 way IDC socket, using the procedure described on page 13 for removing and replacing channels.



*Fig 2-15 : Cable & Channel Connection.*

### Connecting The Meterbridge Interconnect Cable

To connect this cable some of the panels on the meterbridge will require removing to locate the meterbridge distribution board. Once located, find the IDC header labelled on the distribution PCB as "From Output Module". At the back of the mixer chassis there is a slot just above where the output modules sit. Feed the Meterbridge Interconnect cable through the slot and plug it into the header. Once this has been done, replace the meterbridge panels that were removed earlier to locate the distribution board.

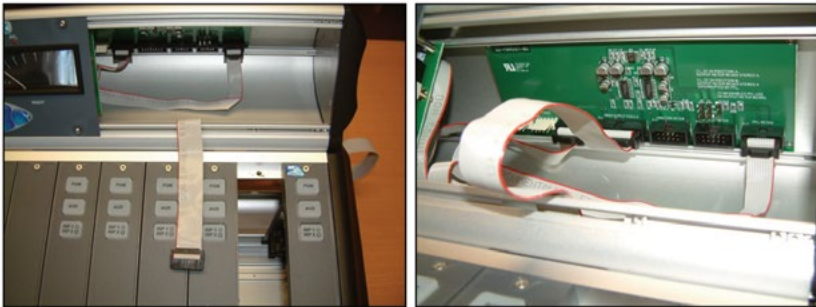

*Fig 2-16 : Meterbridge Interconnection.*

### Connecting The Earth Braid

As with the other cables, this will already be connected to one of the split desks. Simply connect the other end of the cable to the other desk, by unscrewing the outer M4 nut and removing the shakeproof washer. Then place the solder tag of the earth braid cable on the bolt and then replacing the shakeproof and M4 nut.





### 3 Power Supply

#### S2-PSU Power Supply (Old Version)

Each S2 is shipped with a separate power supply in protective packaging and should be inspected for damage before use. Where an item is found to have transit damage, notify the carrier immediately with all the relevant details of the shipment. Packing materials should be kept for inspection.



Fig 3-1 : S2-PSU Front Panel.

#### Front Panel

The S2-PSU is a 2U high rack-mount unit, which can supply power to the entire range of S2 mixers. A lead with a special 9 pin D-Type socket (see Fig 2-9) on each end is used to connect the power supply to the mixer.

The power supply should be installed where there is adequate ventilation for heat to circulate from the rear of the unit. The mixer has a heat sink attached to the rear panel, which radiates some heat.

Four LED's on the front of the unit indicate whether the power to the four voltage rails is being supplied correctly. If one of the LED's fails, then there is a problem with the power supply unit.



Fig 3-2 : S2-PSU Rear Panel.

## Rear Panel

It is important to connect the mains supply in accordance with the information given. Ensure that the rear panel mains voltage statement on the separate power supply indicates that your equipment is suitable for your mains supply voltage and that the mains supply fuse is correctly rated. The fuse as supplied is correct for the voltage setting.

The power cable supplied carries an EARTH conductor, which is connected internally to the equipment chassis ground. This connection through a properly wired power Connector is essential for safe operation. Disconnection of this earth connection may render the Equipment unsafe, with a consequential possible electrical shock hazard from exposed metallic parts.

## Safety of Mains Operated Equipment



This equipment has been designed to meet the safety regulations currently advised in the country of purchase and it conforms to the safety regulations specified by use of the CE Mark.

This equipment will operate in a horizontal position.

**WARNING: The power must be switched off at the supply or the power lead must be disconnected before attempting to remove the panels or cover. Removal of the panels and cover can expose dangerous voltages. The cover is connected to the chassis ground of the equipment by means of fixing screws. It is essential to maintain this earth-ground connection to maintain a safe operating environment.**

In addition, to provide an Electromagnetic Shield, contact between the cover and the chassis must be maintained when in use.

The power supply is switchable between 230V & 115V.

**Warning: There are no user serviceably parts inside the machine. If you should ever need to look inside the unit, always disconnect the mains supply before removing the equipment covers.**

The rear panel of the equipment carries the Serial Number of the machine. The operating voltage of the S2 power supply is selectable at the fuse carrier on the power inlet port of the S2-PSU unit. Ensure that the machine operating voltage is correct for your mains power supply.





### Ordering the Correct Mains Lead

When ordering an S2 from Sonifex, it is helpful if you can specify your required operating voltage and mains lead. After the product code add:

UK, for 230V, UK 3 pin to IEC lead



EC, for 230V, European Schuko 2 pin to IEC lead



US, for 115V, 3 pin to IEC lead



AU for 230V, Australasian 3 pin to IEC lead



### Power Cable and Connection

An IEC power connector is supplied with the S2, which has a moulded plug, attached – this is a legal requirement. If no moulded plug has been supplied with your S2, please contact your supplier, because an IEC connector is always supplied from the Sonifex factory.

The safety specification of your S2 power supply complies with local requirements and must be earthed through the mains connector.

If for any reason, you need to use the S2 with a different power cable, you should use the following wiring guidelines.

**NOTE: The colours of the wires in the mains lead may not correspond with the coloured markings identifying the terminals of your plug.**

Wire Colour	Connection
Green and Yellow wire:	must be connected to the terminal marked with E the colour green or green – yellow.
Blue wire:	must be connected to the terminal marked N or coloured black.
Brown wire:	must be connected to the terminal marked L or coloured red.

### Fuse Rating

The S2 is supplied with a single fuse in the live conducting path of the power infeed at the power supply. For reasons of safety it is important that the correct rating and type of fuse is used. Incorrectly rated fuses could present a possible fire hazard, under equipment fault conditions.

Voltage Setting	Fuse Rating
115V	3.15A (Anti-surge – 20 x 5mm)
230V	3.15A (Anti-surge – 20 x 5mm)



**Power Connector**

This 9 pin D type plug (see Fig 2-9) is used to supply power to the Mixer, and has the following connections;

- Pin A1: +16V.
- Pin A2: -16V.
- Pin A3: 0V.
- Pin A4: +VD.
- Pin 1: +16V Sense.
- Pin 2: -16V Sense.
- Pin 3: 0V Sense.
- Pin 4: +VD Sense.
- Pin 5: +48V.

+VD: Digital power rail.  
 V Sense: Voltage level sensing signals.

**Dimensions (S2-PSU)**

- (Raw): 48cm (W) x 24.3cm (D) x 8.8cm (H)  
 19" (W) x 10" (D) x 3.5" (H)
- (Boxed): 51cm (W) x 41.5cm (D) x 17cm (H)  
 20" (W) x 16.3" (D) x 6.7" (H)

**Weight (S2-PSU)**

Nett: 6kg (13.2lbs) Gross: 7.8kg (17lbs)

**S2-PSU Power Supply (New Version)**



Fig 3-3 : New S2-PSU Front Panel.

The new 1U sized S2-PSU is pin compatible with the original 2U sized S2-PSU power supply, so can be used as a straight like-for-like swap, using the same connection cables. The new units have a serial number greater than 16852 and have a great deal of improvements on the original design:



Increased power efficiency, so that less power is drawn and therefore less heat generated.

An improved over-current and over-voltage protection system to give increased reliability and stability.

A dynamically controlled quiet cooling fan which is only switched on when required by the load conditions and temperature (greater than 50° C).

A new 1U chassis so it takes up less space in a 19" rack.

A fan failure indicator LED on the front panel so that in the unlikely event that the cooling system should fail, a visible warning is given with the LED flashing red.



Fig 3-4: New S2-PSU Rear Panel.

#### Important Notes:

Please note that **ALL** connections to the mixer should be made before powering up the S2-PSU, otherwise this could trigger the over-current protection. If the over-current protection kicks in, then the unit needs to be powered down for approximately a minute to reset the over-current protection.

This 1U sized S2-PSU is incompatible with S2-PSUS power supply switchers with a serial number of 16948 or earlier. The S2-PSUS has been redesigned (from April 2011) to work with both 1U and 2U S2-PSU power supplies, but this is only for S2-PSUS switchers with a serial number higher than 16948. Contact Sonifex if you need to replace a 2U S2-PSU and are using an S2-PSUS power supply switcher - either a new version of the S2-PSUS will be required or a 2U S2-PSU power supply will need to be specifically requested.

The fan is started and run briefly every few minutes to check that it is in operation and to ensure that it doesn't freeze through lack of use over time.

#### Dimensions (S2-PSU)

(Raw):	48.3cm (W) x 23cm (D) x 4.4cm (H) 19" (W) x 9" (D) x 1.7" (H)
(Boxed):	51cm (W) x 41.5cm (D) x 17cm (H) 20" (W) x 16.3" (D) x 6.7" (H)
Weight (S2-PSU)	Nett: 2.9kg Gross: 4.3kg Nett: 6.4lbs Gross: 9.5lbs



## S2-PSUS Dual Power Supply Switcher

The S2-PSUS is a passive power switcher which takes the power feeds from 2 x S2-PSU units and switches between them in the event of failure. Two trailing leads 0.5 m in length connect to 2 x S2- PSU units. With LED failure indicators and GPI alarms the S2-PSUS is the perfect dual redundant power supply module.

### Functionality

As an intelligent unit, the S2-PSUS detects changes in the DC levels supplied to the S2. A failure in any one of the +VD, +VE, -VE or +48V power rails, defined by calibrated limits, results in switching to the secondary power unit. If the glitch was temporary and the primary power unit recovers, the S2-PSUS will switch back. Once it has switched back, the unit has to remain stable for one minute for the power supply to be deemed stable again.

A failure count is incremented every time the unit returns and fails within the minute period. Once three failures have occurred the rail is no longer used and the unit will only use the secondary power supply. If the secondary power supply fails, the unit will enter 'Joint Mode' and attempt to complete the power rail set from the primary power supply. Again, if the secondary power supply recovers, it is given a minute to stabilize. Three or more failures on the same rail will result in a permanent failure to that rail. If the same rail fails in both supplies, the unit will cut all power to the mixer except in the case of the phantom power +48V rail.

### Front Panel Indicators



Fig 3-5 : S2-PSUS Front Panel.

Two indicator LEDs on the front of the unit are used to display which power supply is currently supplying the mixer. There are also eight LEDs that display the status for each of the rails.

The LED will stay illuminated when the rail is stable. If the LED flashes quickly (1/4 second), then the level is too high on that rail or if the LED flashes slowly (1/2 second), then the level is too low on that particular rail. If the unit is in 'Joint Mode', then both active LEDs will be on. In this case, if the same rails are good on both, the primary S2-PSU will be supplying the power for those rails.





### Resetting the S2-PSU States

The S2-PSUS detects when a power supply has been removed or unplugged. If this occurs, the S2-PSUS assumes the power supply has been serviced and all failure statistics are refreshed. If a rail has failed permanently, removing or unplugging the supply will allow the rail to be fully tested again, once reinstated. Removing both power supplies will reset the S2-PSUS, indicated by the alternating front led sequence.

### Usage Advice

The unit has been designed to give the user as little down time as possible. If an S2-PSU rail reaches an unrecoverable state, please remove and service it. If an extreme fault occurs (total loss of power) on the +VD rail, the switch over can cause a reset of digital modules which will result in a small audio glitch.

### Rear Panel



Fig 3-6: S2-PSUS Rear Panel.

There are alarm outputs on the rear of the unit, created using opto-isolator switches. These alarm outputs mimic those on the front panel and there is also an alarm relay which operates as a warning for total unit failure. This will come on if the both power supplies have failed.

### Power Input Connectors

Two trailing leads 0.5m in length are used to connect 2 x S2-PSU units to the power switcher.

### Power Output Connector

This 9 pin D type connector (see Fig 2-9) is used to route power to the Mixer from either the master or slave power supply. It has the same connections as the output from the PSU (see above).

### Alarm & Status Connector

This 25 pin D type socket provides alarm and status output for the power switcher and has the following connections;

Pin 1: 0V.

Pin 2: Opto isolated +VE master alarm NPN collector.

Pin 3: Opto isolated +VE master alarm NPN emitter.

Pin 4: Opto isolated +VE slave alarm NPN collector.

- Pin 5: Opto isolated +VE slave alarm NPN emitter.
- Pin 6: Opto isolated -VE master alarm NPN collector.
- Pin 7: Opto isolated -VE master alarm NPN emitter.
- Pin 8: Opto isolated -VE slave alarm NPN collector.
- Pin 9: Opto isolated -VE slave alarm NPN emitter.
- Pin 10: Opto isolated +VD master alarm NPN collector.
- Pin 11: Opto isolated +VD master alarm NPN emitter.
- Pin 12: Opto isolated +VD slave alarm NPN collector.
- Pin 13: Opto isolated +VD slave alarm NPN emitter.
- Pin 14: Opto isolated +48 master alarm NPN collector.
- Pin 15: Opto isolated +48 master alarm NPN emitter.
- Pin 16: Opto isolated +48 slave alarm NPN collector.
- Pin 17: Opto isolated +48 slave alarm NPN emitter.
- Pin 18: Opto isolated master active NPN collector.
- Pin 19: Opto isolated master active NPN emitter.
- Pin 20: Opto isolated slave active NPN collector.
- Pin 21: Opto isolated slave active NPN emitter.
- Pin 22: Master alarm relay contact 1 (makes to pin 23).
- Pin 23: Master alarm relay contact 2 (makes to pin 22).
- Pin 24: 0V.
- Pin 25: 0V.

#### Dimensions (S2-PSUS)

(Raw): 48cm (W) x 23cm (D) x 4.4cm (H)  
19" (W) x 9" (D) x 1.7" (H)

(Boxed): 55cm (W) x 39.3cm (D) x 8.5cm (H)  
21.6" (W) x 15.5" (D) x 3.4" (H)

#### Weight (S2-PSUS)

Nett: 1.58kg (3.5lbs) Gross: 2kg (4.4lbs)

#### Important Notes:

Note 1: S2-PSU units manufactured before June 2006 will need to be modified for use with the S2-PSUS. Contact Sonifex with the serial number of your unit if you wish to add-on the S2-PSUS power supply switcher.

Note 2: The S2-PSUS has been redesigned (from April 2011) to work with both the new 1U S2-PSU and older 2U S2-PSU power supplies. S2-PSUS units with a serial number greater than 16948 are able to work with either S2 power supply, but serial numbers lower than this, only operate with the 2U S2-PSU.

#### Please Note:

There are two jumpers inside the unit to configure it to work with the two types of S2 Power Supply that have been manufactured: the original 2U 19" rack power supply and the new universal input voltage 1U 19" rack style power supply.



# 3

## POWER SUPPLY



### POWER SUPPLY

The factory default is set to the new 1U S2-PSU. Should you be configuring the S2-PSUS to work with a 2U S2-PSU, you have to modify the appropriate jumper/jumpers as shown overleaf.

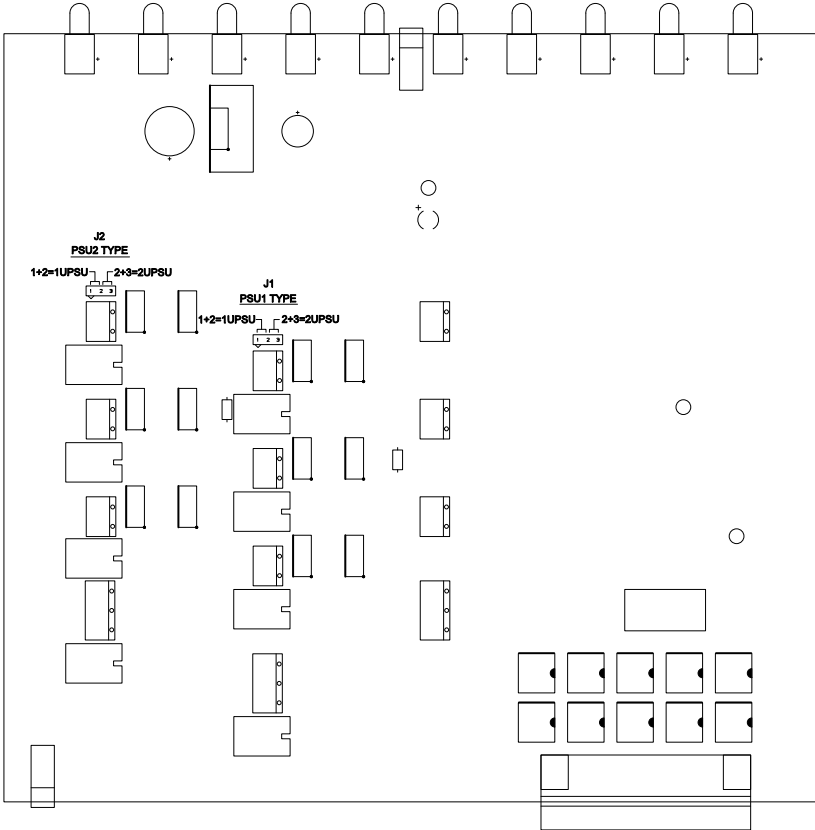

Fig 3-7: New S2-PSU Diagram.

## 4 Input Channels

There are eleven different input channels available for installation in the mixer as well as a blank channel and script space.

The modules carry some common features, such as the ability to select the output as PRG and/or AUD and each button on a module can be programmed in different modes, depending on your requirements. The channels are each covered in the following chapters, but a summary follows:



### S2-CML Mic/Line Input Channel

The Mic/Line Input channel is a mono input with a button switch to select either Mic or Mono Line. If the Mic input is used for the presenter's mic it can also become the talkback mic. The talkback function will be retained when the channel input is switched to Line. Equalisation is fitted as standard on this channel and is enabled by the EQ button, providing 7dB cut and boost at HF (6.5kHz) and LF (100Hz). The Mic input has a jumper selectable high pass filter to remove low frequency intrusions. A Pan control is available to facilitate stereo imaging. A balanced line level insert send and return is available for the Mic input but is disabled in Line mode.

Channel coarse gain is set by internal presets for mic and line – fine gain is trimmed by the front panel Trim control providing  $\pm 12$ dB of gain. The channel has a Pre Fade Listen (CUE/PFL) facility that can be automatically disabled when the fader is opened. There are logic remote input controls for Mic Cough muting and Reverse Talkback, and output controls for Mic cue lights and Line remote start/stop by fader or ON button. The remote outputs on the 9 way D type plug are fed from NPN opto-isolators. The Mic input provides a jumper selectable output to facilitate either Control Room or Studio Muting and Timer functions. In addition the Line input can be configured with all the features of the Mic input when used as a Mic input with an external mic amp.

### S2-CMM Mic/Mic Input Channel

The Mic/Mic Input channel has all the features of the Mic/Line Input channel except that the Line input is replaced by a second Mic input.

### S2-CS Dual Stereo Line Input Channel

The Dual Stereo Input channel has two balanced stereo inputs with a button switch to select between them. Each input is on XLR connectors with internal coarse gain adjustment. Fine gain is trimmed by the front panel Trim control providing  $\pm 12$ dB of gain. A Balance control is available for small adjustments of the stereo image. The channel has a Pre Fade Listen (CUE/PFL) facility that can be automatically disabled when the fader is opened.

There are logic remote output controls for each of the two inputs providing start/stop functions by fader or ON button. The start function can be configured to be either momentary (500mS) or latched for each input. The remote outputs on the 9 way D type plug are fed from NPN opto-isolators.



### S2-CSE Dual Stereo Line Input with EQ Channel

This channel is the Dual Stereo Input channel as above but fitted with equalisation, providing 7dB cut and boost at HF (6.5kHz) and LF (100Hz).

### S2-CSG Stereo Line with Gram Input Channel

This channel is the Dual Stereo Input channel fitted with a RIAA input amplifier on the second input. Input connections for this are unbalanced on phono sockets. This channel is also available with equalisation, type number S2-CSGE.

### S2-CDS Digital Dual Stereo Input Channel

The Digital Dual Stereo Input channel has two 24-bit 96kHz digital inputs with a button switch to select between them. Either input can be configured to be balanced AES/EBU on standard XLR, or S/PDIF on phono sockets, selected by internal jumpers. The digital signals are converted to analogue and from this point the channel functions are the same as the Dual Stereo Line Input channel.

### S2-CDSE Digital Dual Stereo Input with EQ Channel

This channel is the Digital Dual Stereo Input channel as above but fitted with equalisation, providing 7dB cut and boost at HF (6.5kHz) and LF (100Hz).

### S2-C6SS 6 Way Stereo Line Source Select Channel

The 6 Way Stereo Line Source Select channel has 6 balanced stereo inputs on a 25 way D type connector selectable by a 6 way mechanical interlocking switch bank. The switch bank also controls 6 sets of remote outputs allowing each source to have a set of start/stop remotes. The channel is fitted with EQ as standard and other functions similar to the dual stereo input channel.

### S2-CT Telco Input Channel

The Telco Input channel controls the connection to the telephone balance unit (hybrid). It has only one mono input with EQ fitted as standard. Equalisation is enabled by the EQ button, providing 7dB cut and boost at HF (6.5kHz) and LF (100Hz). A Pan control is available to facilitate stereo imaging. A balanced line level output is provided for the cleanfeed back to the hybrid.

Channel coarse gain is set by an internal preset and fine gain is trimmed by the front panel Trim control providing  $\pm 12$ dB of gain. The channel has a Pre Fade Listen (CUE/PFL) facility that automatically routes talkback to the caller when selected. PFL can be automatically disabled when the fader is opened. There is a logic remote output to place the hybrid "on hold" by using the LINE HOLD button. The remote output on the 9 way D type plug is fed from an NPN opto-isolator.

The bus system allows for two true cleanfeed systems when routed to the PGM outputs. Off line phone conversations can be recorded via the AUD bus where a cleanfeed is generated by the mix-minus method.

### S2-CSMM Stereo Mix-Minus Channel

The Stereo Mix-Minus channel has one balanced stereo input and a balanced stereo mix-minus output, on XLR connectors. The channel is intended for use where a remote stereo source, such as another studio connected via ISDN, requires a stereo cleanfeed return. The cleanfeed is generated by the mix-minus method from either the PGM or AUD outputs, depending on the routing selection.

The outputs on this channel can also be configured by jumpers as a mono sum of mix-minus on the left channel and continuous talkback on the right channel (for use with some ISDN codec applications and telephone balance units).

Equalisation is fitted as standard on this channel and is enabled by the EQ button, providing 7dB cut and boost at HF (6.5kHz) and LF (100Hz). Coarse input gain is adjusted internally. Fine gain is trimmed by the front panel Trim control providing  $\pm 12$ dB of gain. A Balance control is available for small adjustments of the stereo image. The channel has a Pre Fade Listen (CUE/PFL) facility that can be automatically disabled when the fader is opened.

There is a logic remote output function controlled by fader or ON button. The remote function can be configured to be either momentary (500mS) or latched. The remote outputs on the 9 way D type plug are fed from NPN opto-isolators.

### S2-PG S2 Penny & Giles Conductive Plastic Fader

The input and output channels of an S2 mixer can optionally be fitted with high quality Penny & Giles faders.





## 5 S2-CML Mic/Line Channel With EQ

### Panel Controls

#### PGM and AUD Selection

Selecting the PGM, AUD buttons routes the channel audio output to the PGM and/or AUD mix buses. The buttons are illuminated in green to indicate the routing status. Changing the status of the PGM button is inhibited when the channel is “live”.

#### MIC/LINE Selection

Selecting the MIC/LINE button changes the channel input connection between Mic and Line. The button is illuminated in red to indicate when Line is selected. The operation of the button is inhibited when the channel is “live”.

#### Equalisation Controls

The HF and LF controls are used to adjust the equalisation of the signal. The HF control boosts and cuts the signal by  $\pm 7$ dB at 6.5kHz. The LF control boosts and cuts the signal by  $\pm 7$ dB at 100Hz. The EQ button places the equalisation in and out of the signal path. The button is illuminated in yellow when the EQ is active.

#### TRIM Control

The Trim control provides an additional  $\pm 12$ dB of gain to fine tune the input signal level.

#### BAL/PAN Control

The Bal control is used to pan the mono input signal in the stereo image. Full anti-clockwise pans the signal to the left and increases the signal by 3dB (right channel reduces by 70dB); full clockwise pans the signal to the right and increases the signal by 3dB (left channel reduces by 70dB).

#### CUE/PFL Selection

Selecting the CUE/PFL button routes the pre-fader input signal to the monitoring system where the signal can be heard via headphones and/or loudspeakers. The level may be checked on meters and adjusted via the TRIM control and panned via the BAL/PAN control. The button is illuminated in green when CUE/PFL is active. There is a jumper option to cancel the CUE/PFL selection when the fader is raised. This button works with both a momentary and latched operation. If held down, the selection is cancelled when released, otherwise the button is alternate action.

#### Fader

The 100mm VCA fader provides unity gain when fully open. The channel input signal is routed to the outputs whenever the fader is open, the ON button is selected and either or both of the routing buttons are selected.



S2-CML



### ON Selection

The ON button works in conjunction with the fader and is used to control channel remotes, routing, timers, etc. The button shows various states. When unlit the channel is off. Flashing red indicates that the channel has been selected to ON but remains unrouted i.e. neither PGM or AUD is selected. Steady red indicates that the channel is ON and “armed”, ready for the fader to be raised. Raising the fader changes the illumination to green indicating that the channel is live. Alternatively, with the button unlit the fader may be raised and the channel can be operated simply by selecting ON. The illumination in this case toggles between unlit, channel OFF and green, channel ON. Remotes, etc, are triggered when the fader is up and the channel ON button shows green.



### Scribble Pad

A scribble pad is provided at the bottom for user labelling of the channel function e.g. “Pres. Mic”

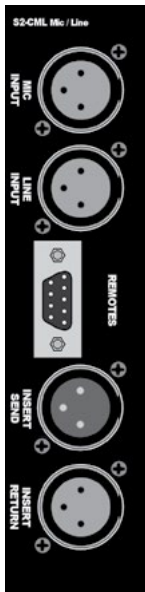

### Rear Panel

#### Mic Input Connector

This XLR 3 pin socket is used for the microphone input and has the following connections;

- Pin 1: Screen.
- Pin 2: Phase.
- Pin 3: Non-phase.

#### Line Input Connector

This XLR 3 pin socket is used for the electronically balanced line input and has the following connections;

- Pin 1: Screen.
- Pin 2: Phase.
- Pin 3: Non-phase.

#### Remotes Connector

This 9 pin D type plug provides inputs and outputs for the following channel functions;

- Mic cue light
- Line remote start
- Line remote stop
- Cough/reverse talkback switch
- Talkback mic enable



The connector pin-out is as follows;

Pin 1: Opto isolated mic cue light NPN collector.

Pin 2: Common NPN emitter for above.

Pin 3: No connection.

Pin 4: Opto isolated Line start NPN collector.

Pin 5: Common NPN emitter for Line start and stop.

Pin 6: Opto isolated Line stop NPN collector.

Pin 7: 0V logic.

Pin 8: Cough/reverse talkback switch (make to 0V to activate).

Pin 9: Talkback mic enable (make to 0V to enable the mic input as the T/B mic).

#### **Insert Send Connector**

This XLR 3 pin plug is a balanced line level pre-EQ output intended to be fed to an effects processor for the microphone input, and has the following connections;

Pin 1: Screen.

Pin 2: Phase.

Pin 3: Non-phase.

#### **Insert Return Connector**

This XLR 3 pin socket is intended for the input signal from the equipment fed by the Insert Send. The connections are the same as the Insert Send connector. The Insert function is disabled in Line mode except when the "Mic on Input 2" jumper is set. See Channel Options.

#### **Channel Options, Jumper Settings and Presets**

The Mic/Line channel with EQ can be configured in a number of different ways depending on the jumper options set on the board. The on-board processor's software is configured by jumpers J1 to J5 and channel identifying links. The Mic/Line channel is identified by having links LK14 and LK15 fitted. Other, customer specific, options can be programmed into the software by special order. Special logic options will be identified by having links LK23 and LK24 fitted.

The standard options available are;

- Using a phantom powered microphone.
- Enable full LF response on microphone input.
- Enable the Insert Point.
- Select momentary or latched start.
- Select monitor mute for studio or control room.
- Select timer option.
- Enable or disable Cue/PFL cancel from fader.
- Enable continuous momentary start from ON button.
- Enable mic on Input 2.

**Summary of Jumper Settings for the Mic/Line Channel With EQ**



Jumper	Set over Pins	Effect
J1	<b>1 &amp; 2</b> None	Latching contact for Mic cue light. Momentary contact for Mic cue light.
J2	1 & 2 <b>None</b>	Latching contact for Line remote start. Momentary contact for Line remote start.
J3	1 & 2 <b>None</b>	Continuous momentary start from ON button, see following description. Normal start function.
J4	1 & 2 <b>None</b>	Fader up signal cancels previously selected Cue/PFL. Normal Cue/PFL function.
J5	1 & 2 <b>None</b>	Microphone on Line input. Normal Line input.
J6	1 & 2 <b>2 &amp; 3</b>	Phantom power to Microphone. Normal operation.
J7	<b>1 &amp; 2</b> None	Full LF response on Microphone input. LF roll off.
J8	Not Fitted	
J9	Not Fitted	
J10	1 & 2 <b>None</b>	Insert point enabled (Insert in). Insert out only.
J11	Not Fitted	
J12	Not Fitted	
J13	<b>1 &amp; 2</b> 2 & 3 None	Control room monitor mute from Microphone input. Studio monitor mute from Microphone input. No mute function.
J14	1 & 2 2 & 3 <b>None</b>	Auto start Timer 1. Auto start Timer 2. No timer function.
J15	1 & 2 2 & 3 <b>None</b>	Control room monitor mute from Line input. Studio monitor mute from Line input. No mute function.
J16	<b>1&amp;2</b> 2&3 None	MIC1 is selected as Talkback input Reserved No Talkback input

**Note:** Options in **bold** are set as default when shipped.

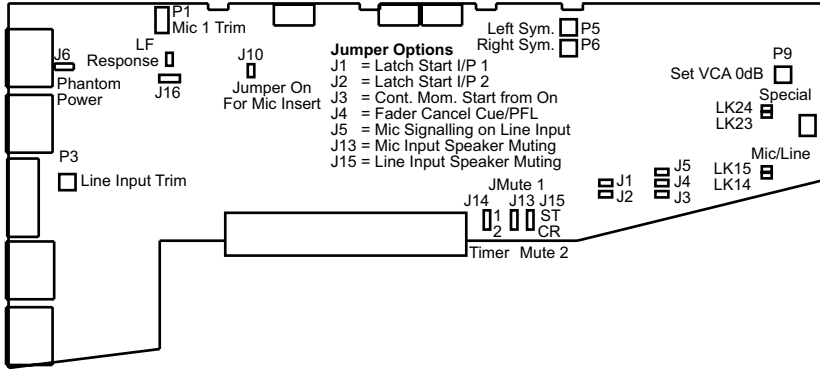

Fig 5-1 : S2 Mic/Line Input Board Layout.

### Remote for Mic Cue Light

The remote output for the Microphone input (Input 1) can be used to operate a Mic Cue light when the channel is ON and the fader is up. This should not be confused with a Mic Live light. The Mic Cue light is used for indicating to presenter or guest that they should talk into the microphone. Jumper J1 is placed over pins 1 & 2. This is the default setting and produces a latched remote output.

### Remote for Line

The remote output for the Line input (Input 2) can be used for starting a machine such as a CD or MD player. The default setting produces a momentary remote output. If a latched output is required then a jumper should be placed over pins 1 & 2 of J2. The remote stop output for the Line input is always momentary.

### Continuous Momentary Start

The continuous momentary start function is rarely used on the Mic/Line channel and therefore J3 should be left in the default setting.

### CUE/PFL Cancel

The CUE/PFL function is normally an alternate action. Press the button to select and press again to de-select. However it may be desirable to have the fader up signal cancel a Cue/PFL selection. Placing a jumper over J4 pins 1 & 2 will enable a previously selected Cue/PFL function to be cancelled when the fader is up and the channel is ON. The default setting is none (not fitted).

### Mic Signalling on Line Input

In certain circumstances it may be desirable that a line input is treated as mic input by the mixers internal logic whilst still being a line level input. For instance, when a mic is used with an external pre-amp or effects unit. A mic pre-amp can therefore be placed on the line input and act in the same way as the standard mic input.

( Please note for external signalling or muting the control room or studio muting functions must still be enabled.)

Placing jumper J5 over pins 1 & 2 will enable the muting functions on the line input. The default setting is none (not fitted).

### **Phantom Power**

If you will be using a phantom powered microphone, jumper J6 must be placed over pins 1 & 2. If a normal microphone is used the jumper should be left over pins 2 & 3. With phantom power selected a voltage of +48V is applied to pins 2 & 3 of the XLR connector. The voltage is applied through 6k8 resistors limiting the current to 14mA. The default setting is with the jumper over pins 2 & 3.

### **Microphone LF Response**

The default setting of J7 is with the jumper over pins 1 & 2 which gives a full LF response to the microphone. However, if your studio is acoustically poor and suffers from a lot of low frequency rumbles the LF response of the microphone can be rolled off at 125Hz, 6dB per octave, to reduce these acoustic problems. This is achieved by removing jumper J7. Jumpers J8 and J9 are not fitted to the Mic/Line channel.

### **Enabling the Insert Point**

The Insert point is useful for hooking up an outboard effects unit to be used with the microphone, for example, a voice processor. The insert send signal is always available as a line level balanced output. The insert return signal is enabled by placing jumper J10 over pins 1 & 2. The insert return function is disabled in Line mode except when jumper J5, Mic on Line Input, is set. The default setting of J10 is none (not fitted).

Jumpers J11 and J12 are not fitted to the Mic/line channel.

### **Mic Live Muting**

The microphone input can be set to mute the control room or studio monitors. The default setting of J13 over pins 1 & 2 will enable a live microphone to mute the control room monitors. If it is required to mute the studio monitors the jumper should be shifted to pins 2 & 3. If no muting is required, the jumper should be removed. When a line level mic is used on input 2, J15 sets the muting function. A jumper over pins 1 & 2 will mute the control room monitors and over pins 2 & 3 will mute the studio monitors. Line input (input 2) muting is only enabled when jumper J5, Mic on Line Input, is set. The default setting of J15 is none (not fitted).

### **Timer Auto Start**

The dual timer in the meterbridge can be set to start automatically from a fader open/channel On signal. Jumper J14 determines which timer is set to auto-start. A jumper over pins 1 & 2 will start Timer 1, shifting the jumper to pins 2 & 3 will start Timer 2. The default setting of J14 is none (not fitted). Please note that the Timer Auto Start is only available on the Line Input.

### **Mic On Talkback Bus**

To enable the microphone input to be added to the talkback bus, connect pins 7 (0V logic) and 9 (Talkback mic enable) on the remote connector. This is useful if, for example, you want to use the mic channel to talk to a caller connected to the cleanfeed output of the telco channel.





### Presets

Two presets are available for adjustment of the input gain for the mic and line levels. The mic preset, P1, provides 59dB of gain adjustment, allowing an input range of -7dB to -66dB. The preset should be adjusted to give 0dB output for the chosen microphone in use. The level is preset for -50dB input when shipped.

The line preset, P3, provides 16dB of gain adjustment, allowing an input range of +6dB to -10dB referenced to 0dB output. The preset should be adjusted to give 0dB output for the chosen source, and will cater for professional equipment with nominal output levels up to +4dB and non-professional equipment with nominal output levels down to -10dBV. The level is preset for 0dB input when shipped.

Presets P5 & P6 are for altering the audio waveform symmetry (i.e. distortion). They are factory set on final test and should not be adjusted further.

A third preset, P9, sets the VCA fader gain to 0dB when the fader is fully open. This is preset on final test and should not require further adjustment, unless it has been found necessary to replace the fader or other VCA components.

### Button Mode Settings

To make the S2 modules as flexible as possible, every button on each channel can be set to a number of different modes. These will aid in the use of the mixer and allow for extra functionality. To make use of these modes, you must enter a setup mode which is exactly the same for every module. It is only necessary to perform this procedure once.

To enter the setup mode, hold down the PGM and AUD buttons together for 5 seconds. After which all the buttons will start a recurring flashing sequence, at this point it is ok to release the PGM and AUD buttons. This sequence indicates the mode which each button is currently set to. One flash equals mode one, two flashes equals mode two etc. To change the mode for a particular button simply press it once and watch the number of flashes increase. Once the maximum mode number has been reached it will simply wrap around to mode one and continue as before. To exit this setup procedure press and hold both the PGM and AUD buttons as before for 2 seconds and the module will start operating as normal.

Each button and their corresponding modes are listed below.

#### PGM

**Mode 1 :** Normal. The program bus can be selected as normal.

**Mode 2 :** Always on. The program bus is permanently selected.

**Mode 3 :** Always off. The program bus is permanently deselected.

#### AUD

**Mode 1 :** Normal. The audition bus can be selected as normal.

**Mode 2 :** Always on. The audition bus is permanently selected.

**Mode 3 :** Always off. The audition bus is permanently deselected.

### MIC/LINE

**Mode 1:** Normal. Can be selected as normal.

**Mode 2:** Always Line. Line is permanently selected.

**Mode 3:** Always MIC. MIC is permanently selected.

### EQ

**Mode 1:** Normal. Equalization can be enabled or disabled as normal.

**Mode 2:** Always enabled. Equalization controls are permanently enabled.

**Mode 3:** Always disabled. Equalization controls are permanently disabled.

### Cue/PFL

**Mode 1:** Normal. Cue/PFL is selected as normal, with both a momentary or latched operation.

**Mode 2:** Latched. Cue/PFL is selected as normal, but will only work with a latched operation.

**Mode 3:** Momentary. Cue/PFL is selected as normal, but will only work with a momentary operation.

### ON

**Mode 1:** Normal.

**Mode 2:** Always on. The channel cannot be turned off.

**Mode 3:** Always on and no LED indication. The channel cannot be turned off and the On button LEDs are never active.





## 6 S2-CMM Mic/Mic Channel With EQ

### Panel Controls

#### PGM and AUD Selection

Selecting the PGM, AUD buttons routes the channel audio output to the PGM and/or AUD mix buses. The buttons are illuminated in green to indicate the routing status. Changing the status of the PGM button is inhibited when the channel is “live”.

#### MIC 1/MIC 2 Selection

Selecting the MIC 1/MIC 2 button changes the channel input connection between MIC 1 and MIC 2. The button is illuminated in red to indicate when MIC 2 is selected. The operation of the button is inhibited when the channel is “live”.

#### Equalisation Controls

The HF and LF controls are used to adjust the equalisation of the signal. The HF control boosts and cuts the signal by  $\pm 7$ dB at 6.5kHz. The LF control boosts and cuts the signal by  $\pm 7$ dB at 100Hz. The EQ button places the equalisation in and out of the signal path. The button is illuminated in yellow when the EQ is active.

#### TRIM Control

The TRIM control provides an additional  $\pm 12$ dB of gain to fine tune the input signal level.

#### BAL/PAN Control

The BAL/PAN control is used to pan the mono input signal in the stereo image. Full anti-clockwise pans the signal to the left and increases the signal by 3dB (right channel reduces by 70dB); full clockwise pans the signal to the right and increases the signal by 3dB (left channel reduces by 70dB).

#### CUE/PFL Selection

Selecting the CUE/PFL button routes the pre-fader input signal to the monitoring system where the signal can be heard via headphones and/or loudspeakers. The level may be checked on meters and adjusted via the Trim control and panned via the Bal control. The button is illuminated in green when CUE/PFL is active. There is a jumper option to cancel the CUE/PFL selection when the fader is raised. This button works with both a momentary and latched operation. If held down, the selection is cancelled when released, otherwise the button is alternate action.

#### Fader

The 100mm VCA fader provides unity gain when fully open. The channel input signal is routed to the outputs whenever the fader is open, the ON button is selected and either or both of the routing buttons are selected.



S2-CMM



### ON Selection

The ON button works in conjunction with the fader and is used to control channel remotes, routing, timers, etc. The button shows various states. When unlit the channel is off. Flashing red indicates that the channel has been selected to ON but remains unrouted i.e. neither PGM or AUD is selected. Steady red indicates that the channel is ON and “armed”, ready for the fader to be raised. Raising the fader changes the illumination to green indicating that the channel is live. Alternatively, with the button unlit the fader may be raised and the channel can be operated simply by selecting ON. The illumination in this case toggles between unlit, channel OFF and green, channel ON. Remotes, etc, are triggered when the fader is up and the channel ON button shows green.



### Scribble Pad

A scribble pad is provided at the bottom for user labelling of the channel function e.g. “Pres. Mic”

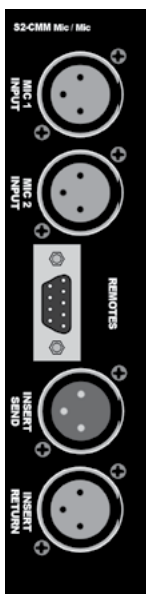

### Rear Panel

#### Mic 1 Input Connector

This XLR 3 pin socket is used for the first microphone input, and has the following connections;

- Pin 1: Screen.
- Pin 2: Phase.
- Pin 3: Non-phase.

#### Mic 2 Input Connector

This XLR 3 pin socket is used for the second microphone input, and has the following connections;

- Pin 1: Screen.
- Pin 2: Phase.
- Pin 3: Non-phase.

#### Remotes Connector

This 9 pin D type plug provides inputs and outputs for the following channel functions;

- Mic 1 cue light
- Mic 2 cue light
- Cough/reverse talkback switch
- Talkback mic enable



The connector pin-out is as follows;

Pin 1: Opto isolated mic 1 cue light NPN collector.

Pin 2: Common NPN emitter for above.

Pin 3: No connection.

Pin 4: Opto isolated mic 2 cue light NPN collector.

Pin 5: Common NPN emitter for above.

Pin 6: No connection.

Pin 7: 0V logic.

Pin 8: Cough/reverse talkback switch (make to 0V to activate).

Pin 9: Talkback mic enable (make to 0V to enable the mic input as the T/B mic).

#### **Insert Send Connector**

This XLR 3 pin plug is a balanced line level pre-EQ output intended to be fed to an effects processor for the microphone input, and has the following connections;

Pin 1: Screen.

Pin 2: Phase.

Pin 3: Non-phase.

#### **Insert Return Connector**

This XLR 3 pin socket is intended for the input signal from the equipment fed by the Insert Send. The connections are the same as the Insert Send connector.

#### **Channel Options, Jumper Settings and Presets**

The Mic/Mic channel can be configured in a number of different ways depending on the jumper options set on the board. The on-board processor's software is configured by jumpers J1 to J4 and channel identifying links. The Mic/Mic channel is identified by having links LK16 and LK17 fitted. Other, customer specific, options can be programmed into the software by special order. Special logic options will be identified by having links LK23 and LK24 fitted.

The standard options available are;

- Using a phantom powered microphone.
- Enable full LF response on microphone inputs.
- Enable the Insert Point.
- Select momentary or Cue Light.
- Select monitor mute for studio or control room.
- Enable or disable Cue/PFL cancel from fader.
- Talkback input selection

### Summary of Jumper Settings for the Mic/Mic Channel With EQ

Jumper	Set over Pins	Effect
J1	<b>1 &amp; 2</b> None	Latching contact for Mic 1 cue light. Momentary contact for Mic 1 cue light.
J2	<b>1 &amp; 2</b> None	Latching contact for Mic 2 cue light. Momentary contact for Mic 2 cue light.
J3	1 & 2 <b>None</b>	Continuous momentary start from ON button, see following description. Normal start function.
J4	1 & 2 <b>None</b>	Fader up signal cancels previously selected Cue/PFL. Normal Cue/PFL function.
J5	Not Fitted	
J6	1 & 2 <b>2 &amp; 3</b>	Phantom power to Microphone 1. Normal operation.
J7	<b>1 &amp; 2</b> None	Full LF response on Microphone 1 input. LF roll off.
J8	1 & 2 <b>2 &amp; 3</b>	Phantom power to Microphone 2. Normal operation.
J9	<b>1 &amp; 2</b> None	Full LF response on Microphone 2 input. LF roll off.
J10	1 & 2 <b>None</b>	Insert point enabled (Insert in). Insert out only.
J11	Not Fitted	
J12	Not Fitted	
J13	<b>1 &amp; 2</b> 2 & 3 None	Control room monitor mute from Microphone 1 input. Studio monitor mute from Microphone 1 input. No mute function.
J14	Not Fitted	
J15	1 & 2 <b>2 &amp; 3</b> None	Control room monitor mute from Microphone 2 input. Studio monitor mute from Microphone 2 input. No mute function.
J16	<b>1&amp;2</b> 2&3 None	MIC1 is selected as Talkback input MIC2 is selected as Talkback input No Talkback input

**Note:** Options in **bold** are set as default when shipped.



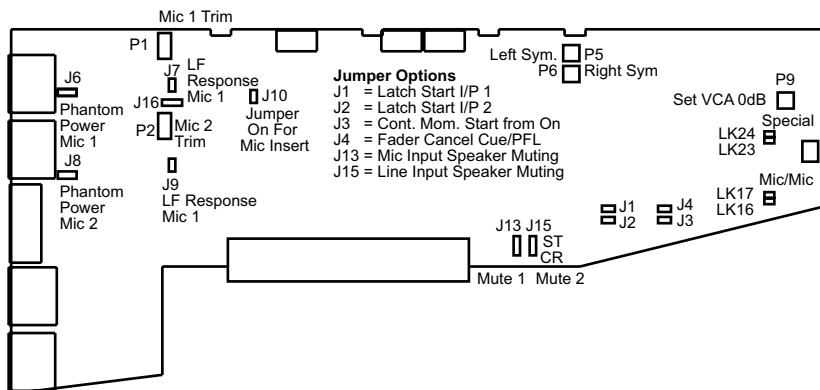

Fig 6-1 : S2 Mic/Mic Input Board Layout.

### Remote for Mic 1 Cue Light

The remote output for the Microphone 1 input can be used to operate a Mic Cue light when the channel is ON and the fader is up. This should not be confused with a Mic Live light. The Mic Cue light is used for indicating to presenter or guest that they should talk into the microphone. Jumper J1 is placed over pins 1 & 2. This is the default setting and produces a latched remote output.

### Remote for Mic 2 Cue Light

The remote output for the Microphone 2 input can be used to operate a Mic Cue light when the channel is ON and the fader is up. This should not be confused with a Mic Live light. The Mic Cue light is used for indicating to presenter or guest that they should talk into the microphone. Jumper J2 is placed over pins 1 & 2. This is the default setting and produces a latched remote output.

### CUE/PFL Cancel

The CUE/PFL function is normally an alternate action. Press the button to select and press again to de-select. However it may be desirable to have the fader up signal cancel a CUE/PFL selection. Placing a jumper over J4 pins 1 & 2 will enable a previously selected CUE/PFL function to be cancelled when the fader is up and the channel is ON. The default setting is none (not fitted).

### Phantom Power Mic 1

If you will be using a phantom powered microphone, jumper J6 must be placed over pins 1 & 2. If a normal microphone is used the jumper should be left over pins 2 & 3. With phantom power selected a voltage of +48V is applied to pins 2 & 3 of the XLR connector. The voltage is applied through 6k8 resistors limiting the current to 14mA. The default setting is with the jumper over pins 2 & 3.

### Mic 1 LF Response

The default setting of J7 is with the jumper over pins 1 & 2 which gives a full LF response to the microphone. However, if your studio is acoustically poor and suffers from a lot of low

frequency rumbles the LF response of the microphone can be rolled off, at 125kHz, 6dB per octave, to reduce these acoustic problems. This is achieved by removing jumper J7.

### Phantom Power Mic 2

If you will be using a phantom powered microphone, jumper J8 must be placed over pins 1 & 2. If a normal microphone is used the jumper should be left over pins 2 & 3. With phantom power selected a voltage of +48V is applied to pins 2 & 3 of the XLR connector. The voltage is applied through 6k8 resistors limiting the current to 14mA. The default setting is with the jumper over pins 2 & 3.

### Mic 2 LF Response

The default setting of J9 is with the jumper over pins 1 & 2 which gives a full LF response to the microphone. However, if your studio is acoustically poor and suffers from a lot of low frequency rumbles the LF response of the microphone can be rolled off, at 125kHz, 6dB per octave, to reduce these acoustic problems. This is achieved by removing jumper J9.

### Enabling the Insert Point

The Insert point is useful for hooking up an outboard effects unit to be used with the microphone. The insert send signal is always available as a line level balanced output. The insert return signal is enabled by placing jumper J10 over pins 1 & 2. The default setting of J10 is none (not fitted).

Jumpers J11 and J12 are not fitted to the Mic/Mic channel.

### Mic Live Muting

The microphone inputs can be set to mute the control room or studio monitors. The default setting of J13 over pins 1 & 2 will enable a live microphone on Mic 1 input to mute the control room monitors. If it is required to mute the studio monitors the jumper should be shifted to pins 2 & 3. If no muting is required, the jumper should be removed. Similarly, J15 sets the muting function for the microphone on Mic 2 input. A jumper over pins 1 & 2 will mute the control room monitors and over pins 2 & 3 will mute the studio monitors. The default setting of J15 is none (not fitted).

### Talkback Mic Selection

When the channel is enabled as a talkback MIC, the talkback input can be selected from either MIC1 or MIC2 using jumper J16. This is independent of the active MIC input. To enable the microphone input to be added to the talkback bus, connect pins 7 (0V logic) and 9 (Talkback mic enable) on the remote connector. This is useful if, for example, you want to use the mic channel to talk to a caller connected to the cleanfeed output of the telco channel.

### Presets

Two presets are available for adjustment of the input gain for mic 1 and mic 2 levels. Mic 1 preset, P1, and Mic 2 preset, P2, provide 59dB of gain adjustment, allowing an input range of -7dB to -66dB. The presets should be adjusted to give 0dB output for the chosen microphones in use. The level is preset for -50dB input when shipped.

Presets P5 & P6 are for altering the audio waveform symmetry (i.e. distortion). They are factory set on final test and should not be adjusted further.





A third preset, P9, sets the VCA fader gain to 0dB when the fader is fully open. This is preset on final test and should not require further adjustment, unless it has been found necessary to replace the fader or other VCA components.

### Button Mode Settings

To make the S2 modules as flexible as possible, every button on each channel can be set to a number of different modes. These will aid in the use of the mixer and allow for extra functionality. To make use of these modes, you must enter a setup mode which is exactly the same for every module. It is only necessary to perform this procedure once.

To enter the setup mode, hold down the PGM and AUD buttons together for 5 seconds. After which all the buttons will start a recurring flashing sequence, at this point it is ok to release the PGM and AUD buttons. This sequence indicates the mode which each button is currently set to. One flash equals mode one, two flashes equals mode two etc. To change the mode for a particular button simply press it once and watch the number of flashes increase. Once the maximum mode number has been reached it will simply wrap around to mode one and continue as before. To exit this setup procedure press and hold both the PGM and AUD buttons as before for 2 seconds and the module will start operating as normal.

Each button and their corresponding modes are listed below.

#### PGM

**Mode 1** : Normal. The program bus can be selected as normal.

**Mode 2** : Always on. The program bus is permanently selected.

**Mode 3** : Always off. The program bus is permanently deselected.

#### AUD

**Mode 1** : Normal. The audition bus can be selected as normal.

**Mode 2** : Always on. The audition bus is permanently selected.

**Mode 3** : Always off. The audition bus is permanently deselected.

#### MIC1/MIC2

**Mode 1** : Normal. Can be selected as normal.

**Mode 2** : Always MIC2. MIC2 is permanently selected.

**Mode 3** : Always MIC1. MIC1 is permanently selected.

#### EQ

**Mode 1** : Normal. Equalization can be enabled or disabled as normal.

**Mode 2** : Always enabled. Equalization controls are permanently enabled.

**Mode 3** : Always disabled. Equalization controls are permanently disabled.

#### Cue/PFL

**Mode 1** : Normal. Cue/PFL is selected as normal, with both a momentary or latched operation.

**7 S2-CSE/S2-CS Dual Stereo Line Channel With & Without EQ**

**Panel Controls**

**PGM and AUD Selection**

Selecting the PGM, AUD buttons routes the channel audio output to the PGM and/or AUD mix buses. The buttons are illuminated in green to indicate the routing status. Changing the status of the PGM button is inhibited when the channel is “live”.

**INP 1/INP 2 Selection**

Selecting the INP 1/INP 2 button changes the channel input connection between Input 1 and Input 2. The button is illuminated in red to indicate when Input 2 is selected. The operation of the button is inhibited when the channel is “live”.

**Equalisation Controls (S2-CSE only)**

The HF and LF controls are used to adjust the equalisation of the signal. The HF control boosts and cuts the signal by  $\pm 7$ dB at 6.5kHz. The LF control boosts and cuts the signal by  $\pm 7$ dB at 100Hz. The EQ button places the equalisation in and out of the signal path. The button is illuminated in yellow when the EQ is active.

**TRIM control**

The TRIM control provides an additional  $\pm 12$ dB of gain to fine tune the input signal level.

**BAL/PAN Control**

The BAL/PAN control can be set to function as either a Balance or Pan control, depending on the setting of J12 & J13. As a balance control, full anti-clockwise shifts the signal to the left and increases the signal by 6dB (right channel reduces by 6dB); full clockwise shifts the signal to the right and increases the signal by 6dB (left channel reduces by 6dB). As a pan control, full anti-clockwise pans the signal to the left and increases the signal by 6dB (right channel reduces by 70dB); full clockwise pans the signal to the right and increases the signal by 6dB (left channel reduces by 70dB).

**CUE/PFL Selection**

Selecting the CUE/PFL button routes the pre-fader input signal to the monitoring system where the signal can be heard via headphones and/or loudspeakers. The level may

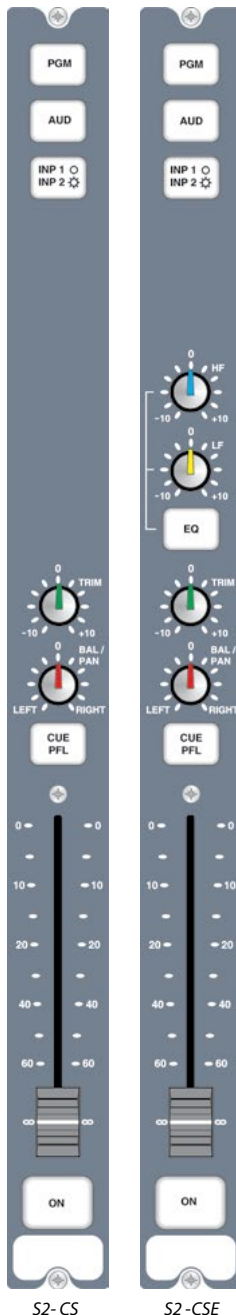

**S2-CSE/S2-CS DUAL STEREO LINE CHANNEL WITH & WITHOUT EQ**

# 7 S2-CSE/S2-CS DUAL STEREO LINE CHANNEL WITH & WITHOUT EQ



be checked on meters and adjusted via the Trim control and balanced via the Bal control. The button is illuminated in green when CUE/PFL is active. There is a jumper option to cancel the CUE/PFL selection when the fader is raised. This button works with both a momentary and latched operation. If held down, the selection is cancelled when released, otherwise the button is alternate action.

## Fader

The 100mm VCA fader provides unity gain when fully open. The channel input signal is routed to the outputs whenever the fader is open, the ON button is selected and either or both of the routing buttons are selected.

## ON Selection

The ON button works in conjunction with the fader and is used to control channel remotes, routing, timers, etc. The button shows various states. When unlit the channel is off. Flashing red indicates that the channel has been selected to ON but remains unrouted i.e. neither PGM or AUD is selected. Steady red indicates that the channel is ON and “armed”, ready for the fader to be raised. Raising the fader changes the illumination to green indicating that the channel is live. Alternatively, with the button unlit the fader may be raised and the channel can be operated simply by selecting ON. The illumination in this case toggles between unlit, channel OFF and green, channel ON. Remotes, etc, are triggered when the fader is up and the channel ON button shows green.

## Scribble Pad

A scribble pad is provided at the bottom for user labelling of the channel function e.g. “MD 1”

## S2-CSE/S2-CS DUAL STEREO LINE CHANNEL WITH & WITHOUT EQ

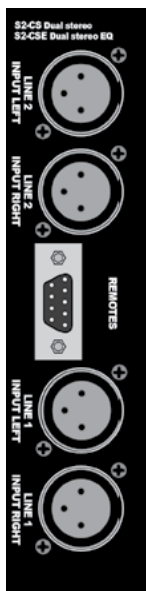

## Rear Panel

### Line 2 Left Input Connector

This XLR 3 pin socket is used for the left analogue channel of input 2, and has the following connections;

- Pin 1: Screen.
- Pin 2: Phase.
- Pin 3: Non-phase.

### Line 2 Right Input Connector

This XLR 3 pin socket is used for the right analogue channel of input 2, and has the following connections;

- Pin 1: Screen.
- Pin 2: Phase.
- Pin 3: Non-phase.

### Remotes Connector

This 9 pin D type plug provides inputs and outputs for the following channel functions;

- Line 1 remote start
- Line 1 remote stop



- Line 2 remote start
- Line 2 remote stop

The connector pin-out is as follows;

- Pin 1: Opto isolated Line 1 start NPN collector.
- Pin 2: Common NPN emitter for Line 1 start and stop.
- Pin 3: Opto isolated Line 1 stop NPN collector.
- Pin 4: Opto isolated Line 2 start NPN collector.
- Pin 5: Common NPN emitter for Line 2 start and stop.
- Pin 6: Opto isolated Line 2 stop NPN collector.
- Pin 7: 0V logic.
- Pin 8: General purpose I/O 1.
- Pin 9: General purpose I/O 2.

#### Line 1 Left Input Connector

This XLR 3 pin socket is used for the left analogue channel of input 1, and has the following connections;

- Pin 1: Screen.
- Pin 2: Phase.
- Pin 3: Non-phase.

#### Line 1 Right Input Connector

This XLR 3 pin socket is used for the right analogue channel of input 1, and has the following connections;

- Pin 1: Screen.
- Pin 2: Phase.
- Pin 3: Non-phase.

### Channel Options, Jumper Settings and Presets

The dual stereo channel with and without EQ can be configured in a number of different ways depending on the jumper options set on the board. The on board processors software is configured by jumpers J1 to J5 and channel identifying links. The dual stereo channel without EQ is identified by having links LK4 and LK11 fitted. The dual stereo channel with EQ is identified by having links LK5 and LK11 fitted. Other, customer specific, options can be programmed into the software by special order. Special logic options will be identified by having links LK9 and LK10 fitted.

The standard options available are;

- Select momentary or latched start for Input 1.
- Select momentary or latched start for Input 2.
- Enable continuous momentary start from ON button.
- Enable or disable Cue/PFL cancel from fader.
- Select timer option.
- Bal/Pan Control Setup





### Summary of Jumper Settings for the Dual Stereo Channel With & Without EQ

Jumper	Set over Pins	Effect
J1	1 & 2 <b>None</b>	Latching contact for Line 1 remote start. Momentary contact for Line 1 remote start.
J2	1 & 2 <b>None</b>	Latching contact for Line 2 remote start. Momentary contact for Line 2 remote start.
J3	1 & 2 <b>None</b>	Continuous momentary start from ON button, see following description. Normal start function.
J4	1 & 2 <b>None</b>	Fader up signal cancels previously selected CUE/PFL. Normal CUE/PFL function.
J5	Not Fitted	
J6	1 & 2 2 & 3 <b>None</b>	Auto start Timer 1. Auto start Timer 2. No timer function.
J7	Not Fitted	
J8	Not Fitted	
J9	Not Fitted	
J10	Not Fitted	
J11	Not Fitted	
J12	1&2 <b>None</b>	Bal/Pan control is a Pan control Bal/Pan control is a Balance control
J13	1&2 <b>None</b>	Bal/Pan control is a Pan control Bal/Pan control is a Balance control

Note: Options in bold are set as default when shipped.

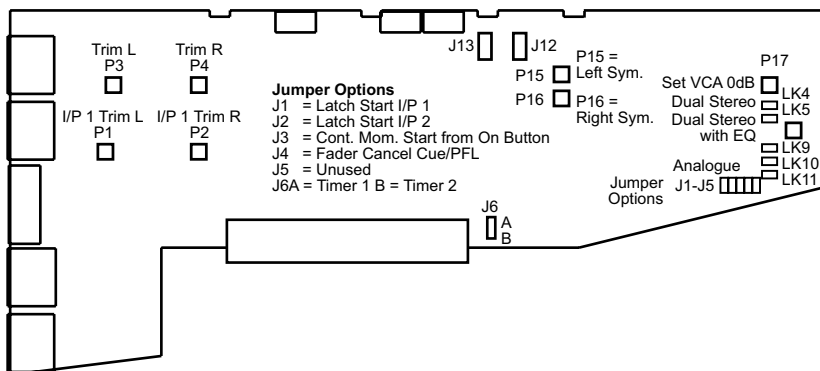

Fig 7-1 : S2 Dual Stereo Input With & Without EQ Board Layout.



### Remote for Line 1 Input

The remote output for the Line 1 input can be used for a start and stop function wired to other studio equipment such as CD or MD players. The default setting for J1 is none (not fitted), which produces a momentary remote contact. If your equipment requires a latching contact for remote start then a jumper should be placed over pins 1 & 2 of J1. The remote stop for Input 1 is always momentary.

### Remote for Line 2 Input

The remote output for the Line 2 input can be used for a start and stop function wired to other studio equipment such as CD or MD players. The default setting for J2 is none (not fitted), which produces a momentary remote contact. If your equipment requires a latching contact for remote start then a jumper should be placed over pins 1 & 2 of J2. The remote stop for Input 2 is always momentary.

### Continuous Momentary Start

The continuous momentary start function can be used for equipment that only ever requires a remote start but not a stop. Placing a jumper over J3 pins 1 & 2 enables the function. When enabled the operation of the ON button is changed to a continuous start button. With the fader down, the button shows red. With the fader up, the button shows green and each press of the ON button will trigger a momentary start from the remote contacts. The default setting for J3 is none (not fitted). It is not possible to configure a latching remote start output when the continuous momentary start option has been selected.

### CUE/PFL Cancel

The CUE/PFL function is normally an alternate action. Press the button to select and press again to de-select. However it may be desirable to have the fader up signal cancel a CUE/PFL selection. Placing a jumper over J4 pins 1 & 2 will enable a previously selected CUE/PFL function to be cancelled when the fader is up and the channel is ON. The default setting is none (not fitted).

Jumper J5 is not fitted to this channel.

### Timer Auto Start

The dual timer in the meterbridge can be set to start automatically from a fader open/channel On signal. Jumper J6 determines which timer is set to auto-start. A jumper over pins 1 & 2 will start Timer 1, shifting the jumper to pins 2 & 3 will start Timer 2. The default setting of J6 is none (not fitted).

Jumpers J7 to J10 are not fitted to this channel.

### Presets

Four presets are available for adjustment of the input gain, left and right, for the two line inputs. Presets, P1 (left), P2 (right) adjust the levels for Line input 1 and P3 (left), P4 (right) for Line input 2. They provide 16dB of gain adjustment, allowing an input range of +6dB to





-10dB referenced to 0dB output. The presets should be adjusted to give 0dB output for the chosen source, and will cater for professional equipment with nominal output levels up to +4dB and non-professional equipment with nominal output levels down to -10dBV. The levels are preset for 0dB input when shipped.

Presets P15 & P16 are for altering the audio waveform symmetry (i.e. distortion). They are factory set on final test and should not be adjusted further.

A seventh preset, P17, sets the VCA fader gain to 0dB when the fader is fully open. This is preset on final test and should not require further adjustment, unless it has been found necessary to replace the fader or other VCA components.

### General Purpose I/O

Two I/O pins are available on the remotes connector that can be configured for general purpose use. They are completely configurable and can be set as inputs or outputs, latching or momentary and active high or active low.

The setup procedure for configuring the pins is described in the following steps. Since the settings are stored in non-volatile RAM, this only needs to be done once.

- To initiate setup, press and hold down the PGM button while pressing the AUD button five times. Once completed, all the buttons will turn off and after a short while will display the current setting for GPIO 1's function (pin 8 on the remote connector).
- Using the PGM button, cycle through the following options (shown in the table below) until the desired setting is selected. For example to set GPIO 1 to a latching, active high input, press the PGM button until only the CUE/PFL button is illuminated ON. This setting is then applied by pressing the ON button. The PGM button will flash quickly for about a second to indicate that the setting is stored.

### General Purpose I/O Function Options

GPIO Function			ON Button	Cue/PFL Button	AUD Button
Input/Output	Latching/ Momentary	Active Low/ Active High			
I	L	AL	OFF	OFF	OFF
I	M	AL	ON	OFF	OFF
I	L	AH	OFF	ON	OFF
I	M	AH	ON	ON	OFF
O	L	AL	OFF	OFF	ON
O	M	AL	ON	OFF	ON
O	L	AH	OFF	ON	ON
O	M	AH	ON	ON	ON

- Now select GPIO 1's action using the PGM button as before.

### General Purpose I/O Action Options

The functions available are dependent on whether the remote is set as an input or an output. The two tables below describe the different functions available.

#### Input Functions

GPIO Action	Description	ON Button	Cue/PFL Button	AUD Button
None	-	OFF	OFF	OFF
Channel ON	The remote pin replicates the ON button in the module. Activating this control will turn the channel on or off.	ON	OFF	OFF
Red ON Indicator	The remote pin activates the Red LED in the ON Button. The ON button mode must be set to mode 5 or 6 when using this action.	OFF	ON	OFF
Green ON Indicator	The remote pin activates the Green LED in the ON Button. The ON button mode must be set to mode 5 or 6 when using this action.	ON	ON	OFF
Fader On	The remote pin controls the fader open function. When active, the fader is fully open.	OFF	OFF	ON

#### Output Functions

GPIO Action	Description	ON Button	Cue/PFL Button	AUD Button
None	-	OFF	OFF	OFF
Channel ON	The remote pin goes active when the channel is LIVE.	ON	OFF	OFF

- As before, press the ON button to apply the setting, noticing that the PGM button flashes.
- The module will now display the current setting of GPIO 2's function. This is changed in exactly the same way as GPIO 1, selecting from the options in the above table.
- Once the ON button is pressed, this setting is stored and the action can be selected.
- After the next ON button press, the module will exit the setup procedure and the module can now be used as normal.

### Button Mode Settings

To make the S2 modules as flexible as possible, every button on each channel can be set to a number of different modes. These will aid in the use of the mixer and allow for extra functionality. To make use of these modes, you must enter a setup mode which is exactly the same for every module. It is only necessary to perform this procedure once.





To enter the setup mode, hold down the PGM and AUD buttons together for 5 seconds. After which all the buttons will start a recurring flashing sequence, at this point it is ok to release the PGM and AUD buttons. This sequence indicates the mode which each button is currently set to. One flash equals mode one, two flashes equals mode two etc. To change the mode for a particular button simply press it once and watch the number of flashes increase. Once the maximum mode number has been reached it will simply wrap around to mode one and continue as before. To exit this setup procedure press and hold both the PGM and AUD buttons as before for 2 seconds and the module will start operating as normal.

Each button and their corresponding modes are listed below.

#### PGM

**Mode 1:** Normal. The program bus can be selected as normal.

**Mode 2:** Always on. The program bus is permanently selected.

**Mode 3:** Always off. The program bus is permanently deselected.

#### AUD

**Mode 1:** Normal. The audition bus can be selected as normal.

**Mode 2:** Always on. The audition bus is permanently selected.

**Mode 3:** Always off. The audition bus is permanently deselected.

#### INP1/INP2

**Mode 1:** Normal. Can be selected as normal.

**Mode 2:** Always INP2. INP2 is permanently selected.

**Mode 3:** Always INP1. INP1 is permanently selected.

#### EQ (S2-CSE only)

**Mode 1:** Normal. Equalization can be enabled or disabled as normal.

**Mode 2:** Always enabled. Equalization controls are permanently enabled.

**Mode 3:** Always disabled. Equalization controls are permanently disabled.

#### Cue/PFL

**Mode 1:** Normal. Cue/PFL is selected as normal, with both a momentary or latched operation.

**Mode 2:** Latched. Cue/PFL is selected as normal, but will only work with a latched operation.



# S2-CSE/S2-CS DUAL STEREO LINE CHANNEL WITH & WITHOUT EQ 7

**Mode 3:** Momentary. Cue/PFL is selected as normal, but will only work with a momentary operation.

**Mode 4:** Normal with remotes. Cue/PFL is selected as normal, with both a momentary or latched operation and will also activate the remotes if the channel is not live.

**Mode 5:** Latched with remotes. Cue/PFL is selected as normal, but with only a latched operation and will also activate the remotes if the channel is not live.

**Mode 6:** Momentary with remotes. Cue/PFL is selected as normal, but with only a momentary operation and will also activate the remotes if the channel is not live.

## ON

**Mode 1:** Normal.

**Mode 2:** Operates as normal, but the remote start function is only activated by the ON button, and generates a START whenever the button is pressed while the fader is up.

**Mode 3:** Always on and no LED indication. The channel cannot be turned off and the On button LEDs are never active.

**Mode 4:** Always on. The channel cannot be turned off.

**Mode 5:** Always on. The LEDs in the ON button are controlled via GPIO.

**Mode 6:** Always on. The LEDs in the ON button are controlled via GPIO and the remote START/STOP functions are generated by the ON button only, but are dependent on the GPIO state. This mode allows the module to interact with the VCS playout system.

Red LED	Green LED	State
OFF	OFF	Not ready. Pressing the ON button will do nothing
ON	OFF	Ready. Pressing the ON button will generate a START.
OFF	ON	Playing. Pressing the ON button will generate a STOP.
ON	ON	Not used.

**Mode 7:** Always on. The remote start function is activated whenever the ON button is pressed, regardless of the fader position.

**Mode 8:** Always on. The remote start function is activated whenever the ON button is pressed and the fader is up or when PFL is active while the fader is down.



## S2-CSE/S2-CS DUAL STEREO LINE CHANNEL WITH & WITHOUT EQ



## 8 S2-CSGE/S2-CSG Stereo Line And Gram Channel With & Without EQ

### Panel Controls

#### PGM and AUD Selection

Selecting the PGM, AUD buttons routes the channel audio output to the PGM and/or AUD mix buses. The buttons are illuminated in green to indicate the routing status. Changing the status of the PGM button is inhibited when the channel is “live”.

#### LINE/GRAM Selection

Selecting the Line/Gram button changes the channel input connection between Stereo Line on XLR and RIAA on phono. The button is illuminated in red to indicate when Gram (RIAA) is selected. The operation of the button is inhibited when the channel is “live”.

#### Equalisation Controls (S2-CSGE only)

The HF and LF controls are used to adjust the equalisation of the signal. The HF control boosts and cuts the signal by  $\pm 7\text{dB}$  at 6.5kHz. The LF control boosts and cuts the signal by  $\pm 7\text{dB}$  at 100Hz. The EQ button places the equalisation in and out of the signal path. The button is illuminated in yellow when the EQ is active.

#### TRIM Control

The TRIM pot provides an additional  $\pm 12\text{dB}$  of gain to fine tune the input level.

#### BAL/PAN Control

The BAL/PAN control can be set to function as either a Balance or Pan control, depending on the setting of J12 & J13. As a balance control, full anti-clockwise shifts the signal to the left and increases the signal by 6dB (right channel reduces by 6dB); full clockwise shifts the signal to the right and increases the signal by 6dB (left channel reduces by 6dB). As a pan control, full anti-clockwise pans the signal to the left and increases the signal by 6dB (right channel reduces by 70dB); full clockwise pans the signal to the right and increases the signal by 6dB (left channel reduces by 70dB).

#### CUE/PFL Selection

Selecting the CUE/PFL button routes the pre-fader input signal to the monitoring system where the signal can be heard via headphones and/or loudspeakers. The level may

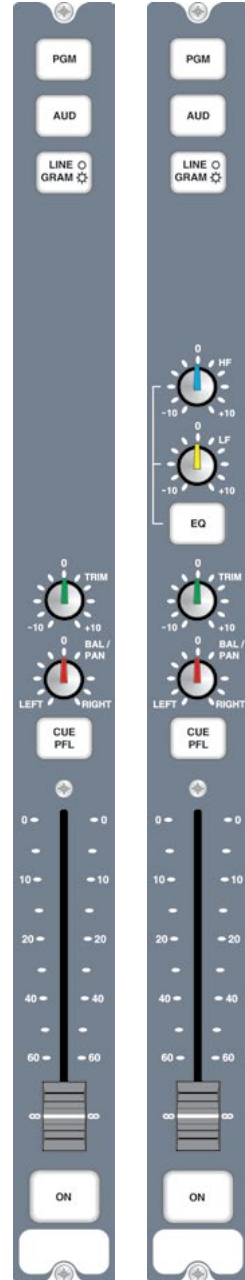

S2-CSG

S2-CSGE



be checked on meters and adjusted via the Trim control and balanced via the Bal control. The button is illuminated in green when CUE/PFL is active. There is a jumper option to cancel the CUE/PFL selection when the fader is raised. This button works with both a momentary and latched operation. If held down, the selection is cancelled when released, otherwise the button is alternate action.

**Fader**

The 100mm VCA fader provides unity gain when fully open. The channel input signal is routed to the outputs whenever the fader is open, the ON button is selected and either or both of the routing buttons are selected.

**ON Selection**

The ON button works in conjunction with the fader and is used to control channel remotes, routing, timers, etc. The button shows various states. When unlit the channel is off. Flashing red indicates that the channel has been selected to ON but remains unrouted i.e. neither PGM or AUD is selected. Steady red indicates that the channel is ON and “armed”, ready for the fader to be raised. Raising the fader changes the illumination to green indicating that the channel is live. Alternatively, with the button unlit the fader may be raised and the channel can be operated simply by selecting ON. The illumination in this case toggles between unlit, channel OFF and green, channel ON. Remotes, etc, are triggered when the fader is up and the channel ON button shows green.

**Scribble Pad**

A scribble pad is provided at the bottom for user labelling of the channel function e.g. “Gram 1”



S2-CSGE/S2-CSG STEREO LINE AND GRAM CHANNEL WITH & WITHOUT EQ

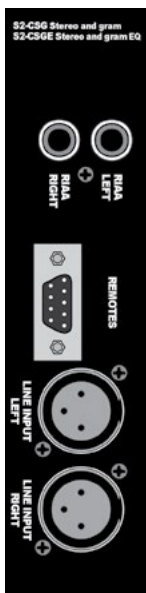

**Rear Panel**

**GRAM Input (RIAA) Left and Right Connector**

These phono connectors are used for the gram RIAA (turntable) left and right inputs. These inputs have on-board RIAA equalisation suitable for magnetic pick up cartridges.

Inner: Phase.  
Outer: Screen.

**Remotes Connector**

This 9 pin D type plug provides inputs and outputs for the following channel functions;

- Line 1 remote start
- Line 1 remote stop
- Line 2 remote start
- Line 2 remote stop



The connector pin-out is as follows;

- Pin 1: Opto isolated Line 1 start NPN collector.
- Pin 2: Common NPN emitter for Line 1 start and stop.
- Pin 3: Opto isolated Line 1 stop NPN collector.
- Pin 4: Opto isolated Gram input start NPN collector.
- Pin 5: Common NPN emitter for Gram input start and stop.
- Pin 6: Opto isolated Gram input stop NPN collector.
- Pin 7: 0V logic.
- Pin 8: General purpose I/O 1.
- Pin 9: General purpose I/O 2.

#### Line 1 Left Input Connector

This XLR 3 pin socket is used for the left channel of input 1, and has the following connections;

- Pin 1: Screen.
- Pin 2: Phase.
- Pin 3: Non-phase.

#### Line 1 Right Input Connector

This XLR 3 pin socket is used for the right channel of input 1, and has the following connections;

- Pin 1: Screen.
- Pin 2: Phase.
- Pin 3: Non-phase.

### Channel Options, Jumper Settings and Presets

The Stereo Line and Gram channel with and without EQ can be configured in a number of different ways depending on the jumper options set on the board. The on-board processor's software is configured by jumpers J1 to J5 and channel identifying links. The Stereo Line and Gram channel without EQ is identified by having links LK6 and LK11 fitted. The Stereo Line and Gram channel with EQ is identified by having links LK7 and LK11 fitted. Other, customer specific, options can be programmed into the software by special order. Special logic options will be identified by having links LK9 and LK10 fitted.

The standard options available are;

- Select momentary or latched start for Input 1.
- Select momentary or latched start for Input 2.
- Enable continuous momentary start from ON button.
- Enable or disable Cue/PFL cancel from fader.
- Select timer option.
- Bal/Pan Control Setup

## Summary of Jumper Settings for the Dual Stereo Gram Channel With & Without EQ

Jumper	Set over Pins	Effect
J1	1 & 2 <b>None</b>	Latching contact for Line 1 remote start. Momentary contact for Line 1 remote start.
J2	1 & 2 <b>None</b>	Latching contact for Gram input remote start. Momentary contact for Gram input remote start.
J3	1 & 2 <b>None</b>	Continuous momentary start from ON button, see following description. Normal start function.
J4	1 & 2 None	Fader up signal cancels previously selected Cue/PFL. Normal Cue/PFL function.
J5	Not Fitted	
J6	1 & 2 2 & 3 <b>None</b>	Auto start Timer 1. Auto start Timer 2. No timer function.
J7	Not Fitted	
J8	Not Fitted	
J9	Not Fitted	
J10	Not Fitted	
J11	Not Fitted	
J12	1&2 <b>None</b>	Bal/Pan control is a Pan control Bal/Pan control is a Balance control
J13	1&2 <b>None</b>	Bal/Pan control is a Pan control Bal/Pan control is a Balance control

**Note:** Options in bold are set as default when shipped.

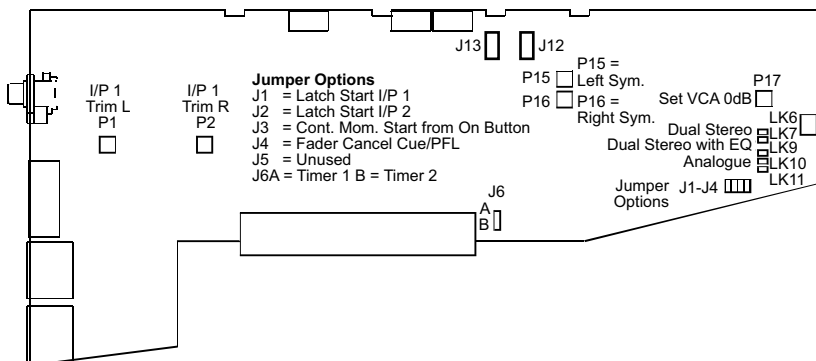

Fig 8-1 : S2 Stereo Line & Gram With & Without EQ Board Layout.



S2-CSGE/S2-CSG STEREO LINE AND GRAM CHANNEL WITH & WITHOUT EQ



### Remote for Line 1 Input

The remote output for the Line 1 input can be used for a start and stop function wired to other studio equipment such as CD or MD players. The default setting for J1 is none (not fitted), which produces a momentary remote contact. If your equipment requires a latching contact for remote start then a jumper should be placed over pins 1 & 2 of J1. The remote stop for Input 1 is always momentary.

### Remote for Gram Input

The remote output for the Gram input can be used for a start and stop function for turntables. The default setting for J2 is none (not fitted), which produces a momentary remote contact. If your equipment requires a latching contact for remote start then a jumper should be placed over pins 1 & 2 of J2. The remote stop for the Gram input is always momentary.

### Continuous Momentary Start

The continuous momentary start function can be used for equipment that only ever requires a remote start but not a stop. Placing a jumper over J3 pins 1 & 2 enables the function. When enabled the operation of the ON button is changed to a continuous start button. With the fader down, the button shows red. With the fader up, the button shows green and each press of the ON button will trigger a momentary start from the remote contacts. The default setting for J3 is none (not fitted). It is not possible to configure a latching remote start output when the continuous momentary start option has been selected.

### CUE/PFL Cancel

The CUE/PFL function is normally an alternate action. Press the button to select and press again to de-select. However it may be desirable to have the fader up signal cancel a CUE/PFL selection. Placing a jumper over J4 pins 1 & 2 will enable a previously selected CUE/PFL function to be cancelled when the fader is up and the channel is ON. The default setting is none (not fitted).

Jumper J5 is not fitted to this channel.

### Timer Auto Start

The dual timer in the meterbridge can be set to start automatically from a fader open/channel On signal. Jumper J6 determines which timer is set to auto-start. A jumper over pins 1 & 2 will start Timer 1, shifting the jumper to pins 2 & 3 will start Timer 2. The default setting of J6 is none (not fitted).

Jumpers J7 to J10 are not fitted to this channel.

### Presets

Two presets are available for adjustment of Line Input 1 gain, left and right. Presets, P1 (left), P2 (right) provide 16dB of gain adjustment, allowing an input range of +6dB to -10dB referenced to 0dB output. The presets should be adjusted to give 0dB output for the chosen source, and will cater for professional equipment with nominal output levels up to +4dB and non-professional equipment with nominal output levels down to -10dBV. The levels are preset for 0dB input when shipped.

The RIAA Gram input level (Input 2) is fixed.

Presets P15 & P16 are for altering the audio waveform symmetry (i.e. distortion). They are factory set on final test and should not be adjusted further.

A fifth preset, P17, sets the VCA fader gain to 0dB when the fader is fully open. This is preset on final test and should not require further adjustment, unless it has been found necessary to replace the fader or other VCA components.

### General Purpose I/O

Two I/O pins are available on the remotes connector that can be configured for general purpose use. They are completely configurable and can be set as inputs or outputs, latching or momentary and active high or active low.

The setup procedure for configuring the pins is described in the following steps. Since the settings are stored in non-volatile RAM, this only needs to be done once.

- To initiate setup, press and hold down the PGM button while pressing the AUD button five times. Once completed, all the buttons will turn off and after a short while will display the current setting for GPIO 1's function (pin 8 on the remote connector).
- Using the PGM button, cycle through the following options (shown in the table below) until the desired setting is selected. For example to set GPIO 1 to a latching, active high input, press the PGM button until only the CUE/PFL button is illuminated ON. This setting is then applied by pressing the ON button. The PGM button will flash quickly for about a second to indicate that the setting is stored.

### General Purpose I/O Function Options

GPIO Function			ON Button	Cue/PFL Button	AUD Button
Input/Output	Latching/ Momentary	Active Low/ Active High			
I	L	AL	OFF	OFF	OFF
I	M	AL	ON	OFF	OFF
I	L	AH	OFF	ON	OFF
I	M	AH	ON	ON	OFF
O	L	AL	OFF	OFF	ON
O	M	AL	ON	OFF	ON
O	L	AH	OFF	ON	ON
O	M	AH	ON	ON	ON

- Now select GPIO 1's action using the PGM button as before.





### General Purpose I/O Action Options

The functions available are dependent on whether the remote is set as an input or an output. The two tables below describe the different functions available.

#### Input Functions

GPIO Action	Description	ON Button	Cue/PFL Button	AUD Button
None	-	OFF	OFF	OFF
Channel ON	The remote pin replicates the ON button in the module. Activating this control will turn the channel on or off.	ON	OFF	OFF
Red ON Indicator	The remote pin activates the Red LED in the ON Button. The ON button mode must be set to mode 5 or 6 when using this action.	OFF	ON	OFF
Green ON Indicator	The remote pin activates the Green LED in the ON Button. The ON button mode must be set to mode 5 or 6 when using this action.	ON	ON	OFF
Fader On	The remote pin controls the fader open function. When active, the fader is fully open.	OFF	OFF	ON

#### Output Functions

GPIO Action	Description	ON Button	Cue/PFL Button	AUD Button
None	-	OFF	OFF	OFF
Channel ON	The remote pin goes active when the channel is LIVE.	ON	OFF	OFF

- As before, press the ON button to apply the setting, noticing that the PGM button flashes.
- The module will now display the current setting of GPIO 2's function. This is changed in exactly the same way as GPIO 1, selecting from the options in the above table.
- Once the ON button is pressed, this setting is stored and the action can be selected.
- After the next ON button press, the module will exit the setup procedure and the module can now be used as normal.

#### Button Mode Settings

To make the S2 modules as flexible as possible, every button on each channel can be set to a number of different modes. These will aid in the use of the mixer and allow for extra



functionality. To make use of these modes, you must enter a setup mode which is exactly the same for every module. It is only necessary to perform this procedure once.

To enter the setup mode, hold down the PGM and AUD buttons together for 5 seconds. After which all the buttons will start a recurring flashing sequence, at this point it is ok to release the PGM and AUD buttons. This sequence indicates the mode which each button is currently set to. One flash equals mode one, two flashes equals mode two etc. To change the mode for a particular button simply press it once and watch the number of flashes increase. Once the maximum mode number has been reached it will simply wrap around to mode one and continue as before. To exit this setup procedure press and hold both the PGM and AUD buttons as before for 2 seconds and the module will start operating as normal.

Each button and their corresponding modes are listed below.

#### PGM

**Mode 1 :** Normal. The program bus can be selected as normal.

**Mode 2 :** Always on. The program bus is permanently selected.

**Mode 3 :** Always off. The program bus is permanently deselected.

#### AUD

**Mode 1 :** Normal. The audition bus can be selected as normal.

**Mode 2 :** Always on. The audition bus is permanently selected.

**Mode 3 :** Always off. The audition bus is permanently deselected.

#### INP1/INP2

**Mode 1 :** Normal. Can be selected as normal.

**Mode 2 :** Always INP2. INP2 is permanently selected.

**Mode 3 :** Always INP1. INP1 is permanently selected.

#### EQ (S2-CSGE only)

**Mode 1 :** Normal. Equalization can be enabled or disabled as normal.

**Mode 2 :** Always enabled. Equalization controls are permanently enabled.

**Mode 3 :** Always disabled. Equalization controls are permanently disabled.

#### Cue/PFL

**Mode 1 :** Normal. Cue/PFL is selected as normal, with both a momentary or latched operation.

**Mode 2 :** Latched. Cue/PFL is selected as normal, but will only work with a latched operation.

**Mode 3 :** Momentary. Cue/PFL is selected as normal, but will only work with a momentary operation.



**Mode 4:** Normal with remotes. Cue/PFL is selected as normal, with both a momentary or latched operation and will also activate the remotes if the channel is not live.

**Mode 5:** Latched with remotes. Cue/PFL is selected as normal, but with only a latched operation and will also activate the remotes if the channel is not live.

**Mode 6:** Momentary with remotes. Cue/PFL is selected as normal, but with only a momentary operation and will also activate the remotes if the channel is not live.

#### ON

**Mode 1:** Normal.

**Mode 2:** Operates as normal, but the remote start function is only activated by the ON button, and generates a START whenever the button is pressed while the fader is up.

**Mode 3:** Always on and no LED indication. The channel cannot be turned off and the ON button LEDs are never active.

**Mode 4:** Always on. The channel cannot be turned off.

**Mode 5:** Always on. The LEDs in the ON button are controlled via GPIO.

**Mode 6:** Always on. The LEDs in the ON button are controlled via GPIO and the remote START/STOP functions are generated by the ON button only, but are dependent on the GPIO state. This mode allows the module to interact with the VCS playout system.

Red LED	Green LED	State
OFF	OFF	Not ready. Pressing the ON button will do nothing
ON	OFF	Ready. Pressing the ON button will generate a START.
OFF	ON	Playing. Pressing the ON button will generate a STOP.
ON	ON	Not used.

**Mode 7:** Always on. The remote start function is activated whenever the ON button is pressed, regardless of the fader position.

**Mode 8:** Always on. The remote start function is activated whenever the ON button is pressed and the fader is up or when PFL is active while the fader is down.



9 S2-CDSE/S2-CDS Digital Dual Stereo Line Channel With & Without EQ

**Panel Controls**

**PGM and AUD Selection**

Selecting the PGM, AUD buttons routes the channel analogue audio output to the PGM and/or AUD mix buses. The buttons illuminate green to indicate the routing status. Changing the status of the PGM button is inhibited for a “live” channel.

**INP 1/INP 2 Selection**

Selecting the INP 1/INP 2 button changes the channel input connection between Input 1 and Input 2. The digital inputs can be configured by internal jumpers to be either AES/EBU or S/PDIF. The button is illuminated in red to indicate when Input 2 is selected. The operation of the button is inhibited for a “live” channel.

**Equalisation Controls (S2-CDSE only)**

The HF and LF controls are used to adjust the equalisation of the signal. The HF control boosts and cuts the signal by ± 7dB at 6.5kHz. The LF control boosts and cuts the signal by ±7dB at 100Hz. The EQ button places the equalisation in and out of the signal path. The button is illuminated in yellow when the EQ is active.

**TRIM Control**

The TRIM pot provides an additional ±12dB of gain to fine tune the input level.

**BAL/PAN Control**

The BAL/PAN control can be set to function as either a Balance or Pan control, depending on the setting of J12 & J13. As a balance control, full anti-clockwise shifts the signal to the left and increases the signal by 6dB (right channel reduces by 6dB); full clockwise shifts the signal to the right and increases the signal by 6dB (left channel reduces by 6dB). As a pan control, full anti-clockwise pans the signal to the left and increases the signal by 6dB (right channel reduces by 70dB); full clockwise pans the signal to the right and increases the signal by 6dB (left channel reduces by 70dB).

**CUE/PFL Selection**

Selecting the CUE/PFL button routes the pre-fader input signal to the monitoring system where the signal can be

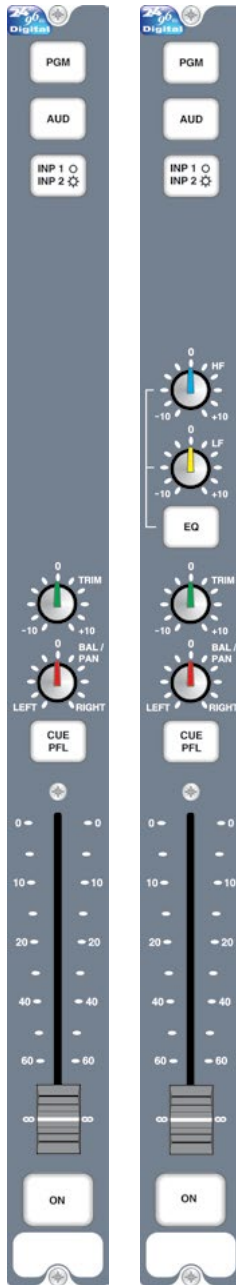

S2-CDS

S2-CDSE



S2-CDSE/S2-CDS DIGITAL DUAL STEREO LINE CHANNEL WITH & WITHOUT EQ



heard via headphones and/or loudspeakers. The level may be checked on meters and adjusted via the Trim control and balanced via the Bal control. The button is illuminated in green when CUE/PFL is active. There is a jumper option to cancel the CUE/PFL selection when the fader is raised. This button works with both a momentary and latched operation. If held down, the selection is cancelled when released, otherwise the button is alternate action.

### Fader

The 100mm VCA fader provides unity gain when fully open. The channel input signal is routed to the outputs whenever the fader is open, the ON button is selected and either or both of the routing buttons are selected.

### ON Selection

The ON button works in conjunction with the fader and is used to control channel remotes, routing, timers, etc. The button shows various states. When unlit the channel is off. Flashing green indicates that there is no valid digital input. Flashing red indicates that the channel has been selected to ON but remains unrouted i.e. neither PGM or AUD is selected. Flashing red and green indicates that both of the above states are valid. Steady red indicates that the channel is ON and "armed", ready for the fader to be raised. Raising the fader changes the illumination to green indicating that the channel is live. Alternatively, with the button unlit the fader may be raised and the channel can be operated simply by selecting ON.

The illumination in this case toggles between unlit, channel OFF and green, channel ON. Remotes, etc, are triggered when the fader is up and the channel ON button shows green.

### Scribble Pad

A scribble pad is provided at the bottom for user labelling of the channel function e.g. "CD 1"

### Rear Panel

#### S/PDIF Input Connector

Two phono connectors are used for S/PDIF Inputs 1 and 2. There are on board jumpers to configure this input in place of the AES/EBU inputs .

Inner: Signal.  
Outer: Screen.

#### Remotes Connector

This 9 pin D type plug provides inputs and outputs for the following channel functions;

- Line 1 remote start
- Line 1 remote stop
- Line 2 remote start
- Line 2 remote stop



The connector pin-outs are as follows;

- Pin 1: Opto isolated Line 1 start NPN collector.
- Pin 2: Common NPN emitter for Line 1 start and stop.
- Pin 3: Opto isolated Line 1 stop NPN collector.
- Pin 4: Opto isolated Line 2 start NPN collector.
- Pin 5: Common NPN emitter for Line 2 start and stop.
- Pin 6: Opto isolated Line 2 stop NPN collector.
- Pin 7: 0V logic.
- Pin 8: General purpose I/O 1.
- Pin 9: General purpose I/O 2.

### Input 1 AES/EBU Connector

This XLR 3 pin socket is used for AES/EBU Input 1, and has the following connections;

- Pin 1: Screen.
- Pin 2: Phase.
- Pin 3: Non-phase.

### Input 2 AES/EBU Connector

This XLR 3 pin socket is used for AES/EBU Input 2, and has the following connections;

- Pin 1: Screen.
- Pin 2: Phase.
- Pin 3: Non-phase.

### Channel Options, Jumper Settings and Presets

The digital dual stereo channel with and without EQ can be configured in a number of different ways depending on the jumper options set on the board. The on-board processor's software is configured by jumpers J1 to J5 and channel identifying links. The digital dual stereo channel without EQ is identified by having links LK4 and LK12 fitted. The digital dual stereo channel with EQ is identified by having links LK5 and LK12 fitted. Other, customer specific, options can be programmed into the software by special order. Special logic options will be identified by having links LK9 and LK10 fitted.

The standard options available are;

- Select momentary or latched start for Input 1 remote output.
- Select momentary or latched start for Input 2 remote output.
- Enable continuous momentary start from ON button.
- Enable or disable Cue/PFL cancel from fader.
- Select timer option.
- Select AES/EBU or S/PDIF for Input 1.
- Select AES/EBU or S/PDIF for Input 2.
- Bal/Pan Control Setup





### Summary of Jumper Settings for the Digital Dual Stereo Channel With & Without EQ

Jumper	Set over Pins	Effect
J1	1 & 2 <b>None</b>	Latching contact for Line 1 remote start. Momentary contact for Line 1 remote start.
J2	1 & 2 <b>None</b>	Latching contact for Line 2 remote start. Momentary contact for Line 2 remote start.
J3	1 & 2 <b>None</b>	Continuous momentary start from ON button, see following description. Normal start function.
J4	1 & 2 <b>None</b>	Fader up signal cancels previously selected CUE/PFL. Normal CUE/PFL function.
J5	1 & 2 <b>None</b>	De-emphasis at 50/15µs, enabled. De-emphasis disabled.
J6	1 & 2 2 & 3 <b>None</b>	Auto start Timer 1. Auto start Timer 2. No timer function.
J7	<b>1 &amp; 2</b> 2 & 3	Input 1 selected from AES/EBU. Input 1 selected from S/PDIF.
J8	<b>1 &amp; 2</b> 2 & 3	Input 2 selected from AES/EBU. Input 2 selected from S/PDIF.
J9	Not Fitted	
J10	Not Fitted	
J11	<b>1 &amp; 2</b> None	PFL is disabled when no digital input is detected Normal PFL function
J12	1&2 <b>None</b>	Bal/Pan control is a Pan control Bal/Pan control is a Balance control
J13	1&2 <b>None</b>	Bal/Pan control is a Pan control Bal/Pan control is a Balance control

Note: Options in bold are set as default when shipped.

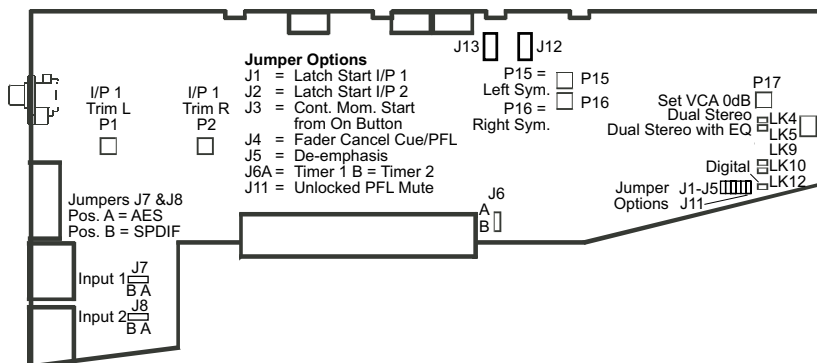

Fig 9-1 : S2 Digital Dual Stereo Input Board Layout.





### Remote for Digital Input 1

The remote output for Input 1 can be used for a start and stop function wired to other studio equipment such as CD or MD players. The default setting for J1 is none (not fitted), which produces a momentary remote contact. If your equipment requires a latching contact for remote start then a jumper should be placed over pins 1 & 2 of J1. The remote stop for Input 1 is always momentary.

### Remote for Digital Input 2

The remote output for Input 2 can be used for a start and stop function wired to other studio equipment such as CD or MD players. The default setting for J2 is none (not fitted), which produces a momentary remote contact. If your equipment requires a latching contact for remote start then a jumper should be placed over pins 1 & 2 of J2. The remote stop for Input 2 is always momentary.

### Continuous Momentary Start

The continuous momentary start function can be used for equipment that only ever requires a remote start but not a stop. Placing a jumper over J3 pins 1 & 2 enables the function. When enabled the operation of the ON button is changed to a continuous start button. With the fader down, the button shows red. With the fader up, the button shows green and each press of the ON button will trigger a momentary start from the remote contacts. The default setting for J3 is none (not fitted). It is not possible to configure a latching remote start output when the continuous momentary start option has been selected.

### CUE/PFL Cancel

The CUE/PFL function is normally an alternate action. Press the button to select and press again to de-select. However it may be desirable to have the fader up signal cancel a CUE/PFL selection. Placing a jumper over J4 pins 1 & 2 will enable a previously selected CUE/PFL function to be cancelled when the fader is up and the channel is ON. The default setting is none (not fitted).

### De-emphasis

Placing a jumper over pins 1 & 2 of J3 will decode 50/15 $\mu$ s emphasis when indicated by certain channel status bits in the incoming digital audio data.

### Disabling PFL When no Input is Detected

When J11 is fitted, if a digital input is not detected on the selected input, then PFL is disabled/muted.

### Timer Auto Start

The dual timer in the meterbridge can be set to start automatically from a fader open/channel On signal. Jumper J6 determines which timer is set to auto-start. A jumper over pins 1 & 2 will start Timer 1, shifting the jumper to pins 2 & 3 will start Timer 2. The default setting of J6 is none (not fitted).

Jumpers J7 to J10 are not fitted to this channel.



### AES/EBU, S/PDIF Select for Input 1

Input 1 can be either balanced AES/EBU or unbalanced S/PDIF. The default setting for J7, pins 1 & 2, is AES/EBU input via XLRs. Shifting the jumper to pins 2 & 3 enables the S/PDIF input on phonos.

### AES/EBU, S/PDIF Select for Input 2

Input 2 can be either balanced AES/EBU or unbalanced S/PDIF. The default setting for J8, pins 1 & 2, is AES/EBU input via XLRs. Shifting the jumper to pins 2 & 3 enables the S/PDIF input on phonos.

### Presets

Two presets are available for adjustment of the input level trim, left and right, for the digital inputs. Presets, P1 (left), P2 (right) provide 15dB of gain adjustment, to compensate for level differences in the digital input circuitry. These are preset on final test and should not require further adjustment.

Presets P15 & P16 are for altering the audio waveform symmetry (i.e. distortion). They are factory set on final test and should not be adjusted further.

A fifth preset, P17, sets the VCA fader gain to 0dB when the fader is fully open. This is preset on final test and should not require further adjustment, unless it has been found necessary to replace the fader or other VCA components.

### General Purpose I/O

Two I/O pins are available on the remotes connector that can be configured for general purpose use. They are completely configurable and can be set as inputs or outputs, latching or momentary and active high or active low.

The setup procedure for configuring the pins is described in the following steps. Since the settings are stored in non-volatile RAM, this only needs to be done once.

- To initiate setup, press and hold down the PGM button while pressing the AUD button five times. Once completed, all the buttons will turn off and after a short while will display the current setting for GPIO 1's function (pin 8 on the remote connector).
- Using the PGM button, cycle through the following options (shown in the table below) until the desired setting is selected. For example to set GPIO 1 to a latching, active high input, press the PGM button until only the CUE/PFL button is illuminated ON. This setting is then applied by pressing the ON button. The PGM button will flash quickly for about a second to indicate that the setting is stored.

### General Purpose I/O Function Options

GPIO Function			ON Button	Cue/PFL Button	AUD Button
Input/Output	Latching/Momentary	Active Low/Active High			
I	L	AL	OFF	OFF	OFF
I	M	AL	ON	OFF	OFF
I	L	AH	OFF	ON	OFF
I	M	AH	ON	ON	OFF
O	L	AL	OFF	OFF	ON
O	M	AL	ON	OFF	ON
O	L	AH	OFF	ON	ON
O	M	AH	ON	ON	ON

- Now select GPIO 1's action using the PGM button as before.

### General Purpose I/O Action Options

The functions available are dependent on whether the remote is set as an input or an output. The two tables below describe the different functions available.

#### Input Functions

GPIO Action	Description	ON Button	Cue/PFL Button	AUD Button
None	-	OFF	OFF	OFF
Channel ON	The remote pin replicates the ON button in the module. Activating this control will turn the channel on or off.	ON	OFF	OFF
Red ON Indicator	The remote pin activates the Red LED in the ON Button. The ON button mode must be set to mode 5 or 6 when using this action.	OFF	ON	OFF
Green ON Indicator	The remote pin activates the Green LED in the ON Button. The ON button mode must be set to mode 5 or 6 when using this action.	ON	ON	OFF
Fader On	The remote pin controls the fader open function. When active, the fader is fully open.	OFF	OFF	ON

#### Output Functions

GPIO Action	Description	ON Button	Cue/PFL Button	AUD Button
None	-	OFF	OFF	OFF
Channel ON	The remote pin goes active when the channel is LIVE.	ON	OFF	OFF





- As before, press the ON button to apply the setting, noticing that the PGM button flashes.
- The module will now display the current setting of GPIO 2's function. This is changed in exactly the same way as GPIO 1, selecting from the options in the above table.
- Once the ON button is pressed, this setting is stored and the action can be selected.
- After the next ON button press, the module will exit the setup procedure and the module can now be used as normal.

### Button Mode Settings

To make the S2 modules as flexible as possible, every button on each channel can be set to a number of different modes. These will aid in the use of the mixer and allow for extra functionality. To make use of these modes, you must enter a setup mode which is exactly the same for every module. It is only necessary to perform this procedure once.

To enter the setup mode, hold down the PGM and AUD buttons together for 5 seconds. After which all the buttons will start a recurring flashing sequence, at this point it is ok to release the PGM and AUD buttons. This sequence indicates the mode which each button is currently set to. One flash equals mode one, two flashes equals mode two etc. To change the mode for a particular button simply press it once and watch the number of flashes increase. Once the maximum mode number has been reached it will simply wrap around to mode one and continue as before. To exit this setup procedure press and hold both the PGM and AUD buttons as before for 2 seconds and the module will start operating as normal.

Each button and their corresponding modes are listed below.

#### PGM

**Mode 1:** Normal. The program bus can be selected as normal.

**Mode 2:** Always on. The program bus is permanently selected.

**Mode 3:** Always off. The program bus is permanently deselected.

#### AUD

**Mode 1:** Normal. The audition bus can be selected as normal.

**Mode 2:** Always on. The audition bus is permanently selected.

**Mode 3:** Always off. The audition bus is permanently deselected.

#### INP1/INP2

**Mode 1:** Normal. Can be selected as normal.

**Mode 2:** Always INP2. INP2 is permanently selected.

**Mode 3:** Always INP1. INP1 is permanently selected.



**EQ (S2-CDSE only)**

- Mode 1:** Normal. Equalization can be enabled or disabled as normal.
- Mode 2:** Always enabled. Equalization controls are permanently enabled.
- Mode 3:** Always disabled. Equalization controls are permanently disabled.

**Cue/PFL**

- Mode 1:** Normal. Cue/PFL is selected as normal, with both a momentary or latched operation.
- Mode 2:** Latched. Cue/PFL is selected as normal, but will only work with a latched operation.
- Mode 3:** Momentary. Cue/PFL is selected as normal, but will only work with a momentary operation.
- Mode 4:** Normal with remotes. Cue/PFL is selected as normal, with both a momentary or latched operation and will also activate the remotes if the channel is not live.
- Mode 5:** Latched with remotes. Cue/PFL is selected as normal, but with only a latched operation and will also activate the remotes if the channel is not live.
- Mode 6:** Momentary with remotes. Cue/PFL is selected as normal, but with only a momentary operation and will also activate the remotes if the channel is not live.

**ON**

- Mode 1:** Normal.
- Mode 2:** Operates as normal, but the remote start function is only activated by the ON button, and generates a START whenever the button is pressed while the fader is up.
- Mode 3:** Always on and no LED indication. The channel cannot be turned off and the On button LEDs are never active.
- Mode 4:** Always on. The channel cannot be turned off.
- Mode 5:** Always on. The LEDs in the ON button are controlled via GPIO.
- Mode 6:** Always on. The LEDs in the ON button are controlled via GPIO and the remote START/STOP functions are generated by the ON button only, but are dependent on the GPIO state. This mode allows the module to interact with the VCS playout system.

Red LED	Green LED	State
OFF	OFF	Not ready. Pressing the ON button will do nothing
ON	OFF	Ready. Pressing the ON button will generate a START.
OFF	ON	Playing. Pressing the ON button will generate a STOP.
ON	ON	Not used.

- Mode 7:** Always on. The remote start function is activated whenever the ON button is pressed, regardless of the fader position.
- Mode 8:** Always on. The remote start function is activated whenever the ON button is pressed and the fader is up or when PFL is active while the fader is down.

# 10

## S2-C6SS 6 WAY STEREO LINE SOURCE SELECT CHANNEL WITH EQ



S2-C6SS 6 WAY STEREO LINE SOURCE SELECT CHANNEL WITH EQ

### 10 S2-C6SS 6 Way Stereo Line Source Select Channel With EQ

#### Panel Controls

##### PGM and AUD Selection

Selecting the PGM, AUD buttons routes the channel audio output to the PGM and/or AUD mix buses. The buttons are illuminated in green to indicate the routing status. Changing the status of the PGM button is inhibited when the channel is “live”.

##### Input Selection

The interlocking switch bank selects one of six stereo inputs. The LED in the buttons indicates the currently selected input. The switches select the individual balanced stereo inputs as well as the remote outputs.

##### Equalisation Controls

The HF and LF controls are used to adjust the equalisation of the signal. The HF control boosts and cuts the signal by  $\pm 7$ dB at 6.5kHz. The LF control boosts and cuts the signal by  $\pm 7$ dB at 100Hz. The EQ button places the equalisation in and out of the signal path. The button is illuminated in yellow when the EQ is active.

##### TRIM Control

The Trim control provides an additional  $\pm 12$ dB of gain to fine tune the input signal level.

##### BAL/PAN Control

The BAL/PAN control is used to balance the stereo image. Full anti-clockwise shifts the signal to the left and increases the signal by 6dB (right channel reduces by 6dB); full clockwise shifts the signal to the right and increases the signal by 6dB (left channel reduces by 6dB).

##### CUE/PFL Selection

Selecting the CUE/PFL button routes the pre-fader input signal to the monitoring system where the signal can be heard via headphones and/or loudspeakers. The level may be checked on meters and adjusted via the Trim control and balanced via the Bal control. The button is illuminated in green when CUE/PFL is active. There is a jumper option to cancel the CUE/PFL selection when the fader is raised. This button works with both a momentary and latched operation. If held down, the selection is cancelled when released, otherwise the button is alternate action.

##### Fader

The 100mm VCA fader provides unity gain when fully open. The channel input signal is routed to the outputs whenever the fader is open, the ON button is selected and either or both of the routing buttons are selected.



S2-C6SS

### ON Selection

The ON button works in conjunction with the fader and is used to control channel remotes, routing, timers, etc. The button shows various states. When unlit the channel is off. Flashing red indicates that the channel has been selected to ON but remains unrouted i.e. neither PGM or AUD is selected. Steady red indicates that the channel is ON and “armed”, ready for the fader to be raised. Raising the fader changes the illumination to green indicating that the channel is live. Alternatively, with the button unlit the fader may be raised and the channel can be operated simply by selecting ON. The illumination in this case toggles between unlit, channel OFF and green, channel ON. Remotes, etc, are triggered when the fader is up and the channel ON button shows green.



### Scribble Pad

A scribble pad is provided at the bottom for user labelling of the channel function e.g. “OS 1”.

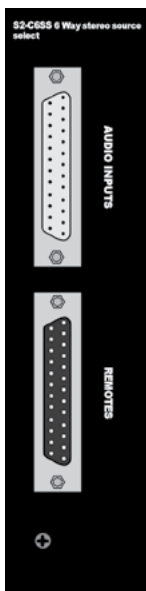

### Rear Panel

#### Stereo Audio Source Input Connector

This 25 pin D type socket is used for all of the Stereo Source inputs, and has the following connections;

- Pin 1: Screen, chassis.
- Pin 2: OS 1 Left phase.
- Pin 3: OS 1 Right phase.
- Pin 4: OS 2 Left phase.
- Pin 5: OS 2 Right phase.
- Pin 6: OS 3 Left phase.
- Pin 7: OS 3 Right phase.
- Pin 8: OS 4 Left phase.
- Pin 9: OS 4 Right phase.
- Pin 10: OS 5 Left phase.
- Pin 11: OS 5 Right phase.
- Pin 12: OS 6 Left phase.
- Pin 13: OS 6 Right phase.
- Pin 14: OS 1 Left non-phase.
- Pin 15: OS 1 Right non-phase.
- Pin 16: OS 2 Left non-phase.
- Pin 17: OS 2 Right non-phase.
- Pin 18: OS 3 Left non-phase.
- Pin 19: OS 3 Right non-phase.
- Pin 20: OS 4 Left non-phase.
- Pin 21: OS 4 Right non-phase.
- Pin 22: OS 5 Left non-phase.
- Pin 23: OS 5 Right non-phase.
- Pin 24: OS 6 Left non-phase.
- Pin 25: OS 6 Right non-phase.



### Source Remotes Connector

This 25 pin D type plug provides remote start/stop outputs for all the sources, and has the following connections;

- Pin 1: Screen, chassis.
- Pin 2: OS 1 Start.
- Pin 3: OS 1 Start Common.
- Pin 4: OS 2 Start.
- Pin 5: OS 2 Start Common.
- Pin 6: OS 3 Start.
- Pin 7: OS 3 Start Common.
- Pin 8: OS 4 Start.
- Pin 9: OS 4 Start Common.
- Pin 10: OS 5 Start.
- Pin 11: OS 5 Start Common.
- Pin 12: OS 6 Start.
- Pin 13: OS 6 Start Common.
- Pin 14: OS 1 Stop.
- Pin 15: OS 1 Stop Common.
- Pin 16: OS 2 Stop.
- Pin 17: OS 2 Stop Common.
- Pin 18: OS 3 Stop.
- Pin 19: OS 3 Stop Common.
- Pin 20: OS 4 Stop.
- Pin 21: OS 4 Stop Common.
- Pin 22: OS 5 Stop.
- Pin 23: OS 5 Stop Common.
- Pin 24: OS 6 Stop.
- Pin 25: OS 6 Stop Common.

### Channel Options, Jumper Settings and Presets

The 6 way stereo line source select with EQ channel can be configured in a number of different ways depending on the jumper options set on the board. The on board processors software is configured by jumpers J1 to J3. Other, customer specific, options can be programmed into the software by special order. Special logic options will be identified by having links LK4 and LK5 fitted.

The standard options available are;

- Enable or disable Cue/PFL cancel from fader.
- Enable continuous momentary start from ON button.
- Select momentary or latched start for all inputs.
- Select timer option.

**Summary of Jumper Settings for the 6 Way Stereo Source Channel With EQ**

Jumper	Set over Pins	Effect
J1	1 & 2 <b>None</b>	Fader up signal cancels previously selected Cue/PFL. Normal Cue/PFL function.
J2	1 & 2 <b>None</b>	Continuous momentary start from ON button, see following description. Normal start function.
J3	1 & 2 <b>None</b>	Latching contact for all remote starts. Momentary contact for all remote starts.
J4	1 & 2 2 & 3 <b>None</b>	Auto start Timer 1. Auto start Timer 2. No timer function.

**Note:** Options in bold are set as default when shipped.

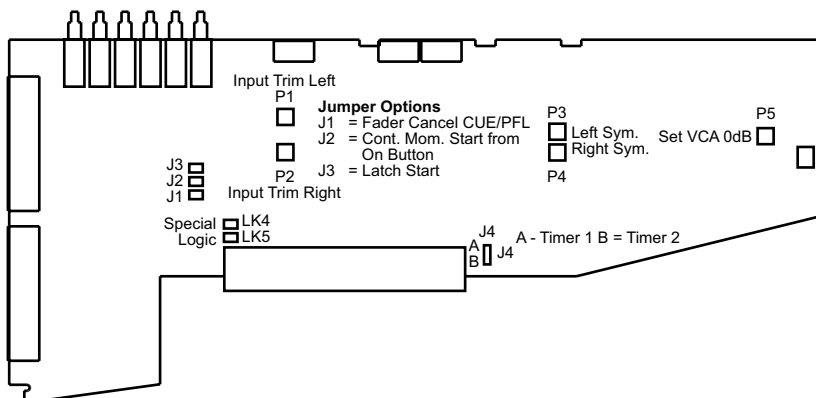

Fig 10-1 : S2 6 Way Source Selector Board Layout.

**Cue/PFL Cancel**

The Cue/PFL function is normally an alternate action. Press the button to select and press again to de-select. However it may be desirable to have the fader up signal cancel a Cue/PFL selection. Placing a jumper over J1 pins 1 & 2 will enable a previously selected Cue/PFL function to be cancelled when the fader is up and the channel is ON. The default setting for J1 is none (not fitted).

**Continuous Momentary Start**

The continuous momentary start function can be used for equipment that only ever requires a remote start but not a stop. Placing a jumper over J2 pins 1 & 2 enables the function. When enabled the operation of the ON button is changed to a continuous start button. With the fader down, the button shows red. With the fader up, the button shows green and each press of the ON button will trigger a momentary start from the remote contacts. The default setting for J2 is none (not fitted).



S2-C6SS 6 WAY STEREO LINE SOURCE SELECT CHANNEL WITH EQ



### Source Remotes

The remote outputs for the six sources can be used for a start and stop function wired to other studio equipment such as CDs or MDs. The default setting for J3 is none (not fitted), which produces a momentary remote contact. If your equipment requires a latching contact for remote start then a jumper should be placed over pins 1 & 2 of J3. The remote stops are always momentary. It is not possible to configure a latching remote start output when the continuous momentary start option has been selected.

### Timer Auto Start

The dual timer in the meterbridge can be set to start automatically from a fader open/channel On signal. Jumper J4 determines which timer is set to auto-start. A jumper over pins 1 & 2 will start Timer 1, shifting the jumper to pins 2 & 3 will start Timer 2. The default setting of J4 is none (not fitted).

### Presets

Two presets are available for adjustment of the input gain, left and right, for all six line inputs. Presets, P1 (left), P2 (right) provide 16dB of gain adjustment, allowing an input range of +6dB to -10dB referenced to 0dB output. The presets should be adjusted to give 0dB output for the chosen source, and will cater for professional equipment with nominal output levels up to +4dB and non-professional equipment with nominal output levels down to -10dBV. The levels are preset for 0dB input when shipped.

A third preset, P5, sets the VCA fader gain to 0dB when the fader is fully open. This is preset on final test and should not require further adjustment, unless it has been found necessary to replace the fader or other VCA components.

Presets P3 & P4 are for altering the audio waveform symmetry (i.e. distortion). They are factory set on final test and should not be adjusted further.

### Button Mode Settings

To make the S2 modules as flexible as possible, every button on each channel can be set to a number of different modes. These will aid in the use of the mixer and allow for extra functionality. To make use of these modes, you must enter a setup mode which is exactly the same for every module. It is only necessary to perform this procedure once.

To enter the setup mode, hold down the PGM and AUD buttons together for 5 seconds. After which all the buttons will start a recurring flashing sequence, at this point it is ok to release the PGM and AUD buttons. This sequence indicates the mode which each button is currently set to. One flash equals mode one, two flashes equals mode two etc. To change the mode for a particular button simply press it once and watch the number of flashes increase. Once the maximum mode number has been reached it will simply wrap around to mode one and continue as before. To exit this setup procedure press and hold both the PGM and AUD buttons as before for 2 seconds and the module will start operating as normal.

Each button and their corresponding modes are listed below.

#### PGM

**Mode 1** : Normal. The program bus can be selected as normal.

**Mode 2** : Always on. The program bus is permanently selected.

**Mode 3** : Always off. The program bus is permanently deselected.

#### AUD

**Mode 1** : Normal. The audition bus can be selected as normal.

**Mode 2** : Always on. The audition bus is permanently selected.

**Mode 3** : Always off. The audition bus is permanently deselected.

#### Source Select

**Mode 1** : Normal. The source can be selected and deselected as normal.

**Mode 2** : Interlocking. The source can only be deselected by the selection of another source.

**Mode 3** : Always off. The source is permanently deselected.

#### EQ

**Mode 1** : Normal. Equalization can be enabled or disabled as normal.

**Mode 2** : Always enabled. Equalization controls are permanently enabled.

**Mode 3** : Always disabled. Equalization controls are permanently disabled.

#### Cue/PFL

**Mode 1** : Normal. Cue/PFL is selected as normal, with both a momentary or latched operation.

**Mode 2** : Latched. Cue/PFL is selected as normal, but will only work with a latched operation.

**Mode 3** : Momentary. Cue/PFL is selected as normal, but will only work with a momentary operation.

**Mode 4** : Normal with remotes. Cue/PFL is selected as normal, with both a momentary or latched operation and will also activate the remotes if the channel is not live.

**Mode 5** : Latched with remotes. Cue/PFL is selected as normal, but with only a latched operation and will also activate the remotes if the channel is not live.

**Mode 6** : Momentary with remotes. Cue/PFL is selected as normal, but with only a momentary operation and will also activate the remotes if the channel is not live.

#### ON

**Mode 1** : Normal.

**Mode 2** : Operates as normal, but the remote start function is only activated by the ON button, and generates a START whenever the button is pressed.

**Mode 3** : Always on and no LED indication. The channel cannot be turned off and the On button LEDs are never active.

**Mode 4** : Always on. The channel cannot be turned off.





## 11 S2-CT Telco Channel With EQ

### Panel Controls

#### PGM and AUD Selection

Selecting the PGM, AUD buttons routes the channel audio output to the PGM and/or AUD mix buses. The buttons are illuminated in green to indicate the routing status. Changing the status of the PGM button is inhibited when the channel is "live". Selecting the PGM button also routes the channel to one of the two true cleanfeed buses. When selecting the AUD button only, a cleanfeed is generated via the channel mix-minus system. When both PGM and AUD are selected the channel operates in the true cleanfeed mode, sending the PGM signal to the cleanfeed bus.

#### Equalisation Controls

The HF and LF controls are used to adjust the equalisation of the signal. The HF control boosts and cuts the signal by  $\pm 7$ dB at 6.5kHz. The LF control boosts and cuts the signal by  $\pm 7$ dB at 100Hz. The EQ button places the equalisation in and out of the signal path. The button is illuminated in yellow when the EQ is active.

#### TRIM control

The TRIM control provides an additional  $\pm 12$ dB of gain to fine tune the input signal level.

#### BAL/PAN Control

The BAL/PAN control is used to pan the mono input signal in the stereo image. Full anti-clockwise pans the signal to the left and increases the signal by 3dB (right channel reduces by 70dB); full clockwise pans the signal to the right and increases the signal by 3dB (left channel reduces by 70dB).

#### CUE/PFL & T/B Selection

Selecting the CUE/PFL & T/B button routes the pre-fader input signal to the monitoring system where the signal can be heard via headphones and/or loudspeakers. The level may be checked on meters and adjusted via the TRIM control and panned via the BAL/PAN control. In addition, talkback is routed back to the caller via the cleanfeed system. This enables the presenter/technical operator to communicate with the caller prior to putting the caller live to air. The button is illuminated in green when CUE/PFL is active. There is a jumper option to cancel the CUE/PFL selection when the fader is raised. This button works with both a momentary and latched operation. If held down, the selection is cancelled when released, otherwise the button is alternate action.

#### Fader

The 100mm VCA fader provides unity gain when fully open. The channel input signal is routed to the outputs whenever the fader is open, the ON



S2-CT



button is selected and either or both of the routing buttons are selected.

### LINE HOLD Selection

The LINE HOLD button works in conjunction with the fader and is used to control channel remotes and routing. The button shows various states. When unlit the channel is off. Flashing red indicates that the channel has been selected to LINE HOLD but remains unrouted i.e. neither PGM or AUD is selected. Steady red indicates that the channel is holding the telephone line and "armed", ready for the fader to be raised. Raising the fader changes the illumination to green indicating that the channel is live. Alternatively, with the button unlit the fader may be raised and the channel can be operated simply by selecting LINE HOLD button (Note though that this will cause dial tone and the dialling of the call to be heard on-air). The illumination in this case toggles between unlit (channel off) and green (channel on). Remotes are triggered when the LINE HOLD button is on.



### Scribble Pad

A scribble pad is provided at the bottom for user labelling of the channel function.

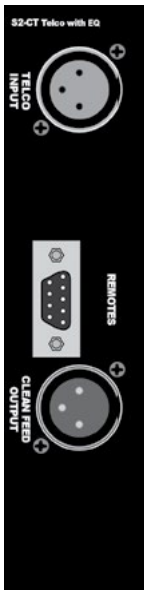

### Rear Panel

#### Telco Line Input Connector

This XLR 3 pin socket is used for the electronically balanced telco line input, and has the following connections;

- Pin 1: Screen.
- Pin 2: Phase.
- Pin 3: Non-phase.

#### Remotes Connector

This 9 pin D type plug provides inputs and outputs for the following channel functions;

- TBU hold

The connector pin-out is as follows;

- Pin 1: Opto isolated TBU hold NPN collector.
- Pin 2: Common NPN emitter for above.
- Pin 3: No connection.
- Pin 4: No connection.
- Pin 5: No connection.
- Pin 6: No connection.
- Pin 7: 0V logic.
- Pin 8: General purpose input.
- Pin 9: No connection.

#### Cleanfeed Output Connector

This XLR 3 pin plug is a balanced line level output intended to be fed back to the TBU.



- Pin 1: Screen.  
 Pin 2: Phase.  
 Pin 3: Non-phase.

### Channel Options, Jumper Settings and Presets

The telco channel with EQ can be configured in a number of different ways depending on the jumper options set on the board. The on-board processor's software is configured by jumpers J1, J4 and channel identifying links. The telco channel is identified by having links LK21 and LK22 fitted. Other, customer specific, options can be programmed into the software by special order. Special logic options will be identified by having links LK23 and LK24 fitted.

The standard options available are;

- Select momentary or latched Hybrid hold.
- Enable or disable Cue/PFL cancel from fader.
- Cleanfeed selection - jumpers J11 & J12 must be set the same for a telco module
- Select timer option.
- Mute Cleanfeed on Talkback enable.

### Summary of Jumper Settings for the Telco Channel With EQ

Jumper	Set over Pins	Effect
J1	<b>1 &amp; 2</b> None	Latching contact for telephone hybrid hold. Momentary contact for telephone hybrid hold.
J2	1&2 <b>None</b>	Mute C/F on Talkback enable. Talkback mixed onto C/F output on Talkback enable.
J3	1&2 <b>None</b>	Continuous momentary start from Line Hold button. Normal start function.
J4	1 & 2 <b>None</b>	Fader up signal cancels previously selected CUE/PFL. Normal Cue/PFL function.
J5	Not Fitted	
J6	Not Fitted	
J7	Not Fitted	
J8	Not Fitted	
J9	Not Fitted	
J10	Not Fitted	
J11	<b>1 &amp; 2</b> 2 & 3	Set-up for cleanfeed bus 1. Set-up for cleanfeed bus 2.
J12	<b>1 &amp; 2</b> 2 & 3	Set-up for cleanfeed bus 1. Set-up for cleanfeed bus 2.
J13	Not Fitted	
J14	Not Fitted	
J15	Not Fitted	

**Note: Options in bold are set as default when shipped.**

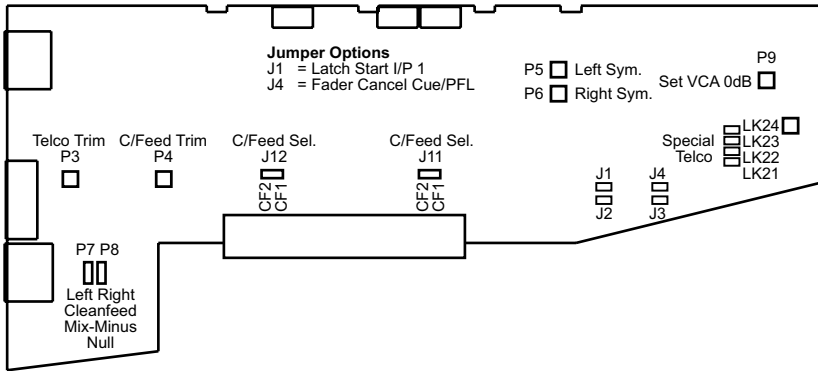

Fig 11-1 : S2 Telco Input Board Layout.

### Remote for Hybrid Hold

The remote output of the Telco channel can be used to hold the line on a telephone hybrid when the channel is ON and the fader is up. The hybrid is also put on hold when the Cue/PFL & T/B button is selected. Jumper J1 is placed over pins 1 & 2. This is the default setting and produces a latched remote output. If your hybrid requires a momentary contact then remove J1.

### CUE/PFL & T/B Cancel

The CUE/PFL & T/B function is normally an alternate action. Press the button to select and press again to de-select. However it may be desirable to have the fader up signal cancel a CUE/PFL & T/B selection. Placing a jumper over J4 pins 1 & 2 will enable a previously selected CUE/PFL & T/B function to be cancelled when the fader is up and the channel is ON. The default setting is none (not fitted).

Jumpers J5 to J10 inclusive are not fitted to the Telco channel.

### Cleanfeed Bus Output Select

The jumpers J11 and J12 determine which of the two true cleanfeed buses the channel uses. There can only be a maximum of two telco channels in each mixer and they must not share a cleanfeed bus.

If you have only one telco channel, the jumpers are fitted over pins 1 & 2 of J11 and J12, using cleanfeed 1. J2 on the S2-ODP should also be fitted to terminate cleanfeed 2.

If a second telco channel is present in the mixer, then this second channel should have the jumpers fitted over pins 2 & 3 of J11 and J12, using cleanfeed 2 only. In this case J2 on the S2-ODP should be removed.

### Using The Mic Input to Talk to Callers Off-Air

To talk to callers connected to a telco module off air using a talkback mic through a mic/line or mic/mic module, firstly link pins 7 and 9 of the remote D-type on the mic/line (see page 30) or mic/mic (see page 38) channel to enable the talkback mic function. Ensure that



Jumper J2 is not set on the telco channel, so that the talkback is mixed to the cleanfeed output. Then to operate, press the PFL button on the telco module so that the mic input, which is connected to the talkback bus, is routed to the cleanfeed bus sent to the caller.

#### Presets

The line input preset, P3, provides 16dB of gain adjustment, allowing an input range of +6dB to -10dB referenced to 0dB output. The preset should be adjusted to give 0dB output for the chosen telephone hybrid, and will cater for professional equipment with nominal output levels up to +4dB and non-professional equipment with nominal output levels down to -10dBV. The level is preset for 0dB input when shipped.

The cleanfeed output level preset, P4, provides 10dB of gain adjustment, allowing an output level from -6dB to +4dB and should be adjusted to suit the level expected by the hybrid in use. The level is preset for 0dB output when shipped.

Presets P5 & P6 are for altering the audio waveform symmetry (i.e. distortion). They are factory set on final test and should not be adjusted further.

Two presets are used to set up the cleanfeed mix-minus null when the channel is routed to AUD only. With the channel routed to AUD only and a signal of 1kHz applied to the input and adjusted to register 0dB on the console output, P7 (left) and P8 (right) are adjusted for minimum signal at the cleanfeed output connector.

A further preset, P9, sets the VCA fader gain to 0dB when the fader is fully open. This is preset on final test and should not require further adjustment, unless it has been found necessary to replace the fader or other VCA components.

#### Terminating The Cleanfeed Buses

Depending on whether you have 1, 2 or no telco channels fitted, you may have to alter the cleanfeed bus termination on the digital PGM and AUD Output channels. Please refer to that section of the handbook for further info.

#### General Purpose Inputs

One input pin is available on the remotes connector that can be configured for general purpose use. It is completely configurable and can be set as latching or momentary and active high or active low.

The setup procedure for configuring the pin is described in the following steps. Since the settings are stored in non-volatile RAM, this only needs to be done once.

- To initiate setup, press and hold down the PGM button while pressing the AUD button five times. Once completed, all the buttons will turn off and after a short while will display the current setting for the inputs function (pin 8 on the remote connector).
- Using the PGM button, cycle through the following options (shown in the table below) until the desired setting is selected. For example to set it to a latching, active high input, press the PGM button until only the CUE/PFL button is illuminated ON. This setting is then applied by pressing the ON button. The PGM button will flash quickly for about a second to indicate that the setting is stored.

### General Purpose Input Function Options

GPIO Function			ON Button	Cue/PFL Button	AUD Button
Input/Output	Latching/Momentary	Active Low/Active High			
I	L	AL	OFF	OFF	OFF
I	M	AL	ON	OFF	OFF
I	L	AH	OFF	ON	OFF
I	M	AH	ON	ON	OFF

- Now select the action using the PGM button as before.

### General Purpose Input Action Options

The functions available are described below.

GPIO Action	Description	ON Button	Cue/PFL Button	AUD Button
None	-	OFF	OFF	OFF
Talkback Enable	The remote pin controls Talkback enable to the C/F outputs.	ON	OFF	OFF
Fader ON	The remote pin controls the fader open function. When active, the fader is fully open.	OFF	ON	OFF
TBU Indicator	The remote pin controls the indicators within the Line Hold button. When this control is active, the Line Hold button will be green. When it is not active it will be red. The Line Hold button mode must be set to Mode 2 when this is used.	ON	ON	OFF

- Press the ON button to apply the setting.
- The module will exit the setup procedure and the module can now be used as normal.

### Button Mode Settings

To make the S2 modules as flexible as possible, every button on each channel can be set to a number of different modes. These will aid in the use of the mixer and allow for extra functionality. To make use of these modes, you must enter a setup mode which is exactly the same for every module. It is only necessary to perform this procedure once.

To enter the setup mode, hold down the PGM and AUD buttons together for 5 seconds. After which all the buttons will start a recurring flashing sequence, at this point it is ok to release the PGM and AUD buttons. This sequence indicates the mode which each button is currently set to. One flash equals mode one, two flashes equals mode two etc. To change the mode for a particular button simply press it once and watch the number of flashes increase.

Once the maximum mode number has been reached it will simply wrap around to mode one and continue as before. To exit this setup procedure press and hold both the PGM and





AUD buttons as before for 2 seconds and the module will start operating as normal.

Each button and their corresponding modes are listed below.

#### PGM

**Mode 1:** Normal. The program bus can be selected as normal.

**Mode 2:** Always on. The program bus is permanently selected.

**Mode 3:** Always off. The program bus is permanently deselected.

#### AUD

**Mode 1:** Normal. The audition bus can be selected as normal.

**Mode 2:** Always on. The audition bus is permanently selected.

**Mode 3:** Always off. The audition bus is permanently deselected.

#### EQ

**Mode 1:** Normal. Equalization can be enabled or disabled as normal.

**Mode 2:** Always enabled. Equalization controls are permanently enabled.

**Mode 3:** Always disabled. Equalization controls are permanently disabled.

#### Cue/PFL & T/B

**Mode 1:** Normal. Cue/PFL is selected as normal, with both a momentary or latched operation.

**Mode 2:** Latched. Cue/PFL is selected as normal, but will only work with a latched operation.

**Mode 3:** Momentary. Cue/PFL is selected as normal, but will only work with a momentary operation.

#### ON

**Mode 1:** Normal.

**Mode 2:** The LEDs in the ON button are controlled via the general purpose input, if configured to do so. If the remote input is not active, then the ON button will be Red. If the remote input is active then the ON button will be green. This is designed to show a visual indication of the state of a TBU connected to the channel.

## 12 S2 CSMM Stereo Mix Minus Channel With EQ

### Panel Controls

#### PGM and AUD Selection

Selecting the PGM, AUD buttons routes the channel audio output to the PGM and/or AUD mix buses. The buttons are illuminated in green to indicate the routing status. Changing the status of the PGM button is inhibited when the channel is “live”. Selecting the PGM button also routes the PGM main output via the mix minus system to the cleanfeed output. Similarly, selecting the AUD button routes the AUD main output to the mix minus system. When both PGM and AUD are selected the mix minus is derived from the PGM output.

#### Equalisation Controls

The HF and LF controls are used to adjust the equalisation of the signal. The HF control boosts and cuts the signal by  $\pm 7$ dB at 6.5kHz. The LF control boosts and cuts the signal by  $\pm 7$ dB at 100Hz. The EQ button places the equalisation in and out of the signal path. The button is illuminated in yellow when the EQ is active.

#### TRIM Control

The TRIM control provides an additional  $\pm 12$ dB of gain to fine tune the input signal level.

#### BAL/PAN Control

The BAL/PAN control can be set to function as either a Balance or Pan control, depending on the setting of J12 & J13. As a balance control, full anti-clockwise shifts the signal to the left and increases the signal by 6dB (right channel reduces by 6dB); full clockwise shifts the signal to the right and increases the signal by 6dB (left channel reduces by 6dB). As a pan control, full anti-clockwise pans the signal to the left and increases the signal by 6dB (right channel reduces by 70dB); full clockwise pans the signal to the right and increases the signal by 6dB (left channel reduces by 70dB).

#### CUE/PFL & T/B Selection

Selecting the CUE/PFL & T/B button routes the pre-fader input signal to the monitoring system where the signal can be heard via headphones and/or loudspeakers. The level may be checked on meters and adjusted via the TRIM control and balanced via the BAL/PAN control. In addition, talkback is routed to the cleanfeed output. This enables the presenter/technical operator to communicate with the remote source prior to going live to air. The button is illuminated in green when CUE/PFL is active. There is a jumper option to cancel the CUE/PFL selection when the fader is raised. This button works with both a momentary and latched operation. If held down, the selection is cancelled when released, otherwise the button is alternate action.



S2-CSMM



S2-CSMM STEREO MIX MINUS CHANNEL WITH EQ

# 12 S2-CSMM STEREO MIX MINUS CHANNEL WITH EQ



The outputs on the this channel can also be configured by jumper settings as a mono sum of mix-minus on the left channel and continuous talkback on the right channel (for use with some ISDN codec applications and telephone balance units).

## Fader

The 100mm VCA fader provides unity gain when fully open. The channel input signal is routed to the outputs whenever the fader is open, the ON button is selected and either or both of the routing buttons are selected.

## ON Selection

The ON button works in conjunction with the fader and is used to control channel remotes, routing, timers, etc. The button shows various states. When unlit the channel is off. Flashing red indicates that the channel has been selected to ON but remains unrouted i.e. neither PGM or AUD is selected. Steady red indicates that the channel is ON and “armed”, ready for the fader to be raised. Raising the fader changes the illumination to green indicating that the channel is live. Alternatively, with the button unlit the fader may be raised and the channel can be operated simply by selecting ON. The illumination in this case toggles between unlit, channel OFF and green, channel ON. Remotes, etc, are triggered when the fader is up and the channel ON button shows green.

## Scribble Pad

A scribble pad is provided at the bottom for user labelling of the channel function e.g. “OB 1”.

## S2-CSMM STEREO MIX MINUS CHANNEL WITH EQ

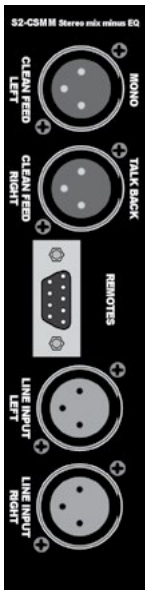

## Rear Panel

### Left Cleanfeed Output Connector

This XLR 3 pin plug is used for the left channel cleanfeed output, and has the following connections;

- Pin 1: Screen.
- Pin 2: Phase.
- Pin 3: Non-phase.

### Right Cleanfeed Output Connector

This XLR 3 pin plug is used for the right channel cleanfeed output, and has the following connections;

- Pin 1: Screen.
- Pin 2: Phase.
- Pin 3: Non-phase.

### Remotes Connector

This 9 pin D type plug provides inputs and outputs for the following channel functions;

- Line input remote start
- Line input remote stop



The connector pin-out is as follows;

- Pin 1: Opto isolated Line input start NPN collector.
- Pin 2: Common NPN emitter for Line 1 start and stop.
- Pin 3: Opto isolated Line input stop NPN collector.
- Pin 4: No connection.
- Pin 5: No connection.
- Pin 6: No connection.
- Pin 7: 0V logic.
- Pin 8: General purpose I/O 1.
- Pin 9: General purpose I/O 2.

### Line Left Input Connector

This XLR 3 pin socket is used for the left channel input, and has the following connections;

- Pin 1: Screen.
- Pin 2: Phase.
- Pin 3: Non-phase.

### Line Right Input Connector

This XLR 3 pin socket is used for the right channel input, and has the following connections;

- Pin 1: Screen.
- Pin 2: Phase.
- Pin 3: Non-phase.

### Channel Options, Jumper Settings and Presets

The stereo mix-minus channel with EQ can be configured in a number of different ways depending on the jumper options set on the board. The on-board processor's software is configured by jumpers J1 to J5 and channel identifying links. The stereo mix-minus channel is identified by having links LK8 and LK11 fitted. Other, customer specific, options can be programmed into the software by special order. Special logic options will be identified by having links LK9 and LK10 fitted.

The standard options available are;

- Select momentary or latched start for the Input.
- Enable continuous momentary start from ON button.
- Enable or disable Cue/PFL cancel from fader.
- Select timer option.
- Cleanfeed output selection.
- Bal/Pan Control Setup



# 12 S2-CSMM STEREO MIX MINUS CHANNEL WITH EQ



S2-CSMM STEREO MIX MINUS CHANNEL WITH EQ

## Summary of Jumper Settings for the Stereo Mix-Minus Channel With EQ

Jumper	Set over Pins	Effect
J1	1 & 2 <b>None</b>	Latching contact for Line input remote start. Momentary contact for Line input remote start.
J2	Not Fitted	
J3	1 & 2 <b>None</b>	Continuous momentary start from ON button, see following description. Normal start function.
J4	1 & 2 <b>None</b>	Fader up signal cancels previously selected Cue/PFL. Normal Cue/PFL function.
J5	1 & 2 <b>None</b>	Mute C/F on Talkback enable. Talkback mixed onto C/F output on Talkback enable.
J6	1 & 2 2 & 3 <b>None</b>	Auto start Timer 1. Auto start Timer 2. No timer function.
J7	Not Fitted	
J8	Not Fitted	
J9	<b>1 &amp; 2</b> 2 & 3	Cleanfeed left to C/F output left. Cleanfeed mono to C/F output left.
J10	<b>1 &amp; 2</b> 2 & 3	Cleanfeed right to C/F output right. Continuous talkback (T/B 1) to C/F output right.
J11	Not Fitted	
J12	1&2 <b>None</b>	Bal/Pan control is a Pan control Bal/Pan control is a Balance control
J13	1&2 <b>None</b>	Bal/Pan control is a Pan control Bal/Pan control is a Balance control

Note: Options in bold are set as default when shipped.

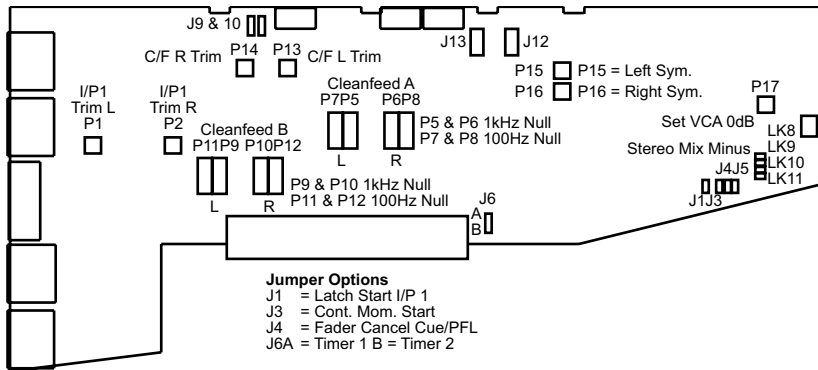

Fig 12-1 : S2 Stereo Mix-Minus Board Layout.



## Remote for Line Input

The remote output for the Line input can be used for a start and stop function wired to other studio equipment such as CD or MD players. The default setting for J1 is none (not fitted), which produces a momentary remote contact. If your equipment requires a latching contact for remote start then a jumper should be placed over pins 1 & 2 of J1. The remote stop is always momentary.

## Continuous Momentary Start

The continuous momentary start function can be used for equipment that only ever requires a remote start but not a stop. Placing a jumper over J3 pins 1 & 2 enables the function. When enabled the operation of the ON button is changed to a continuous start button. With the fader down, the button shows red. With the fader up, the button shows green and each press of the ON button will trigger a momentary start from the remote contacts. The default setting for J3 is none (not fitted). It is not possible to configure a latching remote start output when the continuous momentary start option has been selected.

## CUE/PFL Cancel

The CUE/PFL function is normally an alternate action. Press the button to select and press again to de-select. However it may be desirable to have the fader up signal cancel a CUE/PFL selection. Placing a jumper over J4 pins 1 & 2 will enable a previously selected CUE/PFL function to be cancelled when the fader is up and the channel is ON. The default setting is none (not fitted).

Jumper J5 is not fitted to this channel.

## Timer Auto Start

The dual timer in the meterbridge can be set to start automatically from a fader open/channel On signal. Jumper J6 determines which timer is set to auto-start. A jumper over pins 1 & 2 will start Timer 1, shifting the jumper to pins 2 & 3 will start Timer 2. The default setting of J6 is none (not fitted).

Jumpers J7 and J8 are not fitted to this channel.

## Cleanfeed Output Selection

The default setting for jumpers J9 and J10 is over pins 1 & 2 which gives stereo cleanfeed outputs. There may be a situation where only mono cleanfeed is required with a continuous feed of talkback from the studio. Placing jumper J9 over pins 2 & 3 places mono cleanfeed on the left cleanfeed output and placing jumper J10 over pins 2 & 3 places the continuous talkback feed on the right cleanfeed output.

## Presets

Two presets are available for adjustment of the Line Input gain, left and right. Presets, P1 (left), P2 (right) provide 16dB of gain adjustment, allowing an input range of +6dB to -10dB referenced to 0dB output. The presets should be adjusted to give 0dB output for the chosen source, and will cater for professional equipment with nominal output levels up to +4dB and non-professional equipment with nominal output levels down to -10dBV. The levels are preset for 0dB input when shipped.

# 12 S2-CSMM STEREO MIX MINUS CHANNEL WITH EQ



## S2-CSMM STEREO MIX MINUS CHANNEL WITH EQ

Eight presets are used to adjust the cleanfeed null for the left and right channels. Cleanfeed is derived from the PGM or AUD output buses and are set up as follows. With the channel routed to PGM only and a signal of 1kHz applied to the input and adjusted to register 0dB on the console output, P5 (left) and P6 (right) are adjusted for minimum signal at the cleanfeed output connectors. The input signal frequency is then changed to 100Hz and P7 (left) and P8 (right) are adjusted for a level of -45dB at the cleanfeed output connectors. Change the routing to AUD only and repeat the set up using presets P9, P10 at 1kHz and P11, P12 at 100Hz. This will be set up during final test and should not require further adjustment, unless the channel position changes within the frame when minor adjustment may be required to maintain best performance.

Two presets are available for adjustment of the Cleanfeed gain, left and right. The presets P13 (left), P14 (right) should be adjusted to give 0dB output for the chosen source.

Presets P15 & P16 are for altering the audio waveform symmetry (i.e. distortion). They are factory set on final test and should not be adjusted further.

A further preset, P17, sets the VCA fader gain to 0dB when the fader is fully open. This is preset on final test and should not require further adjustment, unless it has been found necessary to replace the fader or other VCA components.

### General Purpose I/O

Two I/O pins are available on the remotes connector that can be configured for general purpose use. They are completely configurable and can be set as inputs or outputs, latching or momentary and active high or active low.

The setup procedure for configuring the pins is described in the following steps. Since the settings are stored in non-volatile RAM, this only needs to be done once.

- To initiate setup, press and hold down the PGM button while pressing the AUD button five times. Once completed, all the buttons will turn off and after a short while will display the current setting for GPIO 1's function (pin 8 on the remote connector).
- Using the PGM button, cycle through the following options (shown in the table below) until the desired setting is selected. For example to set GPIO 1 to a latching, active high input, press the PGM button until only the CUE/PFL button is illuminated ON. This setting is then applied by pressing the ON button. The PGM button will flash quickly for about a second to indicate that the setting is stored.

### General Purpose I/O Function Options

GPIO Function			ON Button	Cue/PFL Button	AUD Button
Input/Output	Latching/Momentary	Active Low/Active High			
I	L	AL	OFF	OFF	OFF
I	M	AL	ON	OFF	OFF
I	L	AH	OFF	ON	OFF
I	M	AH	ON	ON	OFF
O	L	AL	OFF	OFF	ON
O	M	AL	ON	OFF	ON
O	L	AH	OFF	ON	ON
O	M	AH	ON	ON	ON

- Now select GPIO 1's action using the PGM button as before.

### General Purpose I/O Action Options

The functions available are dependent on whether the remote is set as an input or an output. The two tables below describe the different functions available.

#### Input Functions

GPIO Action	Description	ON Button	Cue/PFL Button	AUD Button
None	-	OFF	OFF	OFF
Channel ON	The remote pin replicates the ON button in the module. Activating this control will turn the channel on or off.	ON	OFF	OFF
Talkback Enable	The remote pin controls Talkback enable to the C/F outputs.	OFF	ON	OFF
TBU Indicator	The remote pin controls the indicators within the ON button. When this control is active, the ON button will be green. When it is not active it will be red. The ON button mode must be set to Mode 3 when this action is used.	ON	ON	OFF
Fader On	The remote pin controls the fader open function. When active, the fader is fully open.	OFF	OFF	ON

#### Output Functions

GPIO Action	Description	ON Button	Cue/PFL Button	AUD Button
None	-	OFF	OFF	OFF
Channel ON	The remote pin goes active when the channel is LIVE.	ON	OFF	OFF
Talkback Enable	The remote pin goes active when Talkback is enabled.	OFF	ON	OFF





- As before, press the ON button to apply the setting, noticing that the PGM button flashes.
- The module will now display the current setting of GPIO 2's function. This is changed in exactly the same way as GPIO 1, selecting from the options in the above table.
- Once the ON button is pressed, this setting is stored and the action can be selected.
- After the next ON button press, the module will exit the setup procedure and the module can now be used as normal.

## Button Mode Settings

To make the S2 modules as flexible as possible, every button on each channel can be set to a number of different modes. These will aid in the use of the mixer and allow for extra functionality. To make use of these modes, you must enter a setup mode which is exactly the same for every module. It is only necessary to perform this procedure once.

To enter the setup mode, hold down the PGM and AUD buttons together for 5 seconds. After which all the buttons will start a recurring flashing sequence, at this point it is ok to release the PGM and AUD buttons. This sequence indicates the mode which each button is currently set to. One flash equals mode one, two flashes equals mode two etc. To change the mode for a particular button simply press it once and watch the number of flashes increase. Once the maximum mode number has been reached it will simply wrap around to mode one and continue as before. To exit this setup procedure press and hold both the PGM and AUD buttons as before for 2 seconds and the module will start operating as normal.

Each button and their corresponding modes are listed below.

### PGM

**Mode 1 :** Normal. The program bus can be selected as normal.

**Mode 2 :** Always on. The program bus is permanently selected.

**Mode 3 :** Always off. The program bus is permanently deselected.

### AUD

**Mode 1 :** Normal. The audition bus can be selected as normal.

**Mode 2 :** Always on. The audition bus is permanently selected.

**Mode 3 :** Always off. The audition bus is permanently deselected.

### EQ

**Mode 1 :** Normal. Equalization can be enabled or disabled as normal.

**Mode 2 :** Always enabled. Equalization controls are permanently enabled.

**Mode 3 :** Always disabled. Equalization controls are permanently disabled.

## Cue/PFL

**Mode 1:** Normal. Cue/PFL is selected as normal, with both a momentary or latched operation.

**Mode 2:** Latched. Cue/PFL is selected as normal, but will only work with a latched operation.

**Mode 3:** Momentary. Cue/PFL is selected as normal, but will only work with a momentary operation.

**Mode 4:** Normal with remotes. Cue/PFL is selected as normal, with both a momentary or latched operation and will also activate the remotes if the channel is not live.

**Mode 5:** Latched with remotes. Cue/PFL is selected as normal, but with only a latched operation and will also activate the remotes if the channel is not live.

**Mode 6:** Momentary with remotes. Cue/PFL is selected as normal, but with only a momentary operation and will also activate the remotes if the channel is not live.

## ON

**Mode 1:** Normal.

**Mode 2:** Operates as normal except the start function is activated from first fader up and on combination. Thereafter, subsequent lowering and raising of the fader does not activate a start or stop. Stop is only generated when channel is turned off.

**Mode 3:** The LEDs in the ON button are driven by the GPIO set to TBU indicator mode.





### 13 Output Channels

There are six different output channels, available for installation in the mixer as well as a blank channel and script space. The channels are each covered in the following chapters, but a summary follows:

#### **S2-ODP Digital PGM Output Channel & S2-ODPF Digital PGM Output Channel With Master Fader**

This channel is common to every mixer and provides a digital and analogue stereo output from the PGM mix bus and a mono analogue output. The digital output is available as a balanced AES/EBU signal via standard XLRs or as S/PDIF on phono sockets. The sample rate can be set automatically or by internal jumpers from 32 kHz to 96 kHz. The output sample size can be set to 16, 18 or 24 bits on Version 1 modules, but is always 24 bits on Version 2 modules. The balanced analogue PGM output and mono output is available on a 15 way D type connector.

Button switches at the top of the channel select the mono output source. The S2-ODPF version has output faders for production use.

#### **S2-ODA Digital AUD Output Channel & S2-ODAF Digital AUD Output Channel With Master Fader**

This channel is common to every mixer and provides a digital and analogue output from the AUD mix bus. The digital output is available as a balanced AES/EBU signal via standard XLRs or as S/PDIF on phono sockets. The sample rate can be set automatically or by internal jumpers from 32 kHz to 96 kHz. The output sample size can be set to 16, 18 or 24 bits on Version 1 modules, but is always 24 bits on Version 2 modules. The balanced analogue AUD outputs are available on a 15 way D type connector.

Button switches at the top of the channel select the monitoring source to the meterbridge. The S2-ODAF version has output faders for production use.

#### **S2-OMC Control Room Monitor Channel**

The Control Room Monitor channel is used for the monitoring of various sources on the control room loudspeakers and (presenters) headphones. A suitable power amplifier connected to the channel monitor output must be used to drive the loudspeakers. A front panel control is used to vary the monitor level. Headphones can be driven directly from the channel headphone connector on the front or rear panel via the level control.

A 4 way electronically interlocking switch bank selects the source routed to the speakers and headphones from either of two external inputs, the PGM, or AUD output. "Auto PFL" buttons adjacent to each level control allow the monitoring of PFL when an input channel has been selected to CUE/PFL. In addition, Split PFL can be selected to the headphones, which will place the selected source in mono in one ear and PFL in mono in the other.

This channel controls the signal conditioning for the talkback input and output and routes these signals to and from the talkback bus. Internal jumpers can be configured to allow talkback to replace or dim the selected source. A Global Talkback system can be configured



to allow every contribution point in the control room and studio to communicate with each other via their microphone and headphones.

An illuminated Mute LED shows when a live microphone channel in the control room has muted the control room speakers.

### S2-OMS Studio Monitor Channel

The Studio Monitor channel is used for the monitoring of various sources on the studio loudspeakers and headphones. A suitable power amplifier connected to the channel monitor output must be used to drive the loudspeakers. A front panel control is used to vary the monitor level. Headphones can be driven directly from the channel headphone connector on the rear panel via the level control.

A 4 way electronically interlocking switch bank selects the source routed to the speakers and headphones from either of two external inputs, the PGM, or AUD output. "Auto PFL" buttons adjacent to each level control allow the monitoring of PFL when an input channel has been selected to CUE/PFL.

A separate Studio T/B button is provided to allow the presenter/engineer to talk to the studio at other times and internal jumpers allow this talkback to replace or dim the selected source. A Global Talkback system can be configured to allow every contribution point in the control room and studio to communicate with each other via their microphone and headphones.

An illuminated Mute LED shows when a live microphone channel in the studio has muted the studio speakers.



# 14

## S2-ODPF/S2-ODP DIGITAL OUTPUT PGM CHANNEL WITH & WITHOUT MASTER FADER (VERSION 1)



### S2-ODPF/S2-ODP DIGITAL OUTPUT PGM CHANNEL WITH & WITHOUT MASTER FADER (VERSION 1)

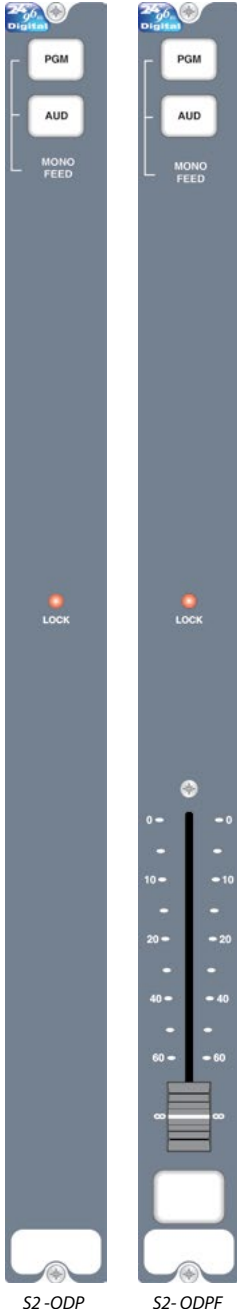

S2-ODP

S2-ODPF

### 14 S2-ODPF/S2-ODP Digital Output PGM Channel With & Without Master Fader (Version 1)

A change was made to the hardware and firmware of the S2-ODPF/S2-ODP modules around January 2008. Modules prior to this date are likely to be Version 1, modules after this date are likely to be Version 2. Externally, the only way to check the Version number of this module which has been fitted into your S2, is to look at the layout of the connectors on the rear panel. If the POWER and OUTPUTS AND REMOTES connector is at the bottom of the panel (see page 99), then you have a Version 2 module. If these connectors are nearer the middle of the panel (see page 92), then it is Version 1.

#### Panel Controls

##### Mono Output Selection

The Mono compatible output can be used to feed a mono transmitter or any station output monitoring system that requires a mono signal such as a background music system. The Mono output can be derived from either the PGM or AUD outputs by selecting the appropriate button.

##### Lock Indicator

The illuminated lock indicator shows that the digital output is locked to the onboard master clock, incoming Word clock or AES/EBU, S/PDIF compatible sync signal. If sync is lost then the indicator will flash. The channel automatically searches for a sync signal on the Word Clock, or the selected digital input, and automatically locks to a valid sync clock. To disable locking to the AES/EBU or S/PDIF input, simply remove jumpers J10 and J11.

##### Fader (S2-ODPF only)

The 100mm VCA fader provides unity gain when fully open.

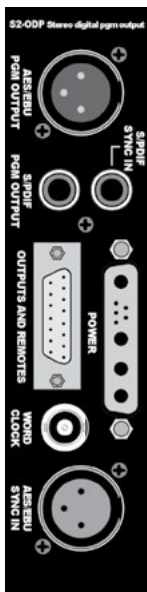

## Rear Panel

### AES/EBU PGM Output Connector

This XLR 3 pin plug is used for the AES/EBU Output, and has the following connections;

- Pin 1: Screen.
- Pin 2: Phase.
- Pin 3: Non-phase.

### S/PDIF PGM Output Connector

This phono connector is used for S/PDIF output. There are on board jumpers to set up this input in place of the AES/EBU output.

- Inner: Signal.
- Outer: Screen.

### S/PDIF Sync Input Connector

This phono connector is used for the S/PDIF sync input. There is an on board jumper to set up this input in place of the AES/EBU sync input.

- Inner: Signal.
- Outer: Screen.

### Outputs & Remotes Connector

This 15 pin D type socket provides outputs for the following channel functions;

- PGM analogue outputs
- Mono analogue output
- Control Room muting relays. The mute relay is a double pole relay, 2A at 30VDC max

The connector pin-out is as follows;

- Pin 1: Chassis ground.
- Pin 2: PGM left output phase.
- Pin 3: PGM right output phase.
- Pin 4: No connection.
- Pin 5: No connection.
- Pin 6: Mono output phase.
- Pin 7: Control Room mute relay contact 1A (makes to pin 14).
- Pin 8: Control Room mute relay contact 2A (makes to pin 15).
- Pin 9: PGM left output non-phase.
- Pin 10: PGM right output non-phase.
- Pin 11: No connection.
- Pin 12: No connection.
- Pin 13: Mono output non-phase.
- Pin 14: Control Room mute relay contact 1B.
- Pin 15: Control Room mute relay contact 2B.



S2-ODPF/S2-ODP DIGITAL OUTPUT PGM CHANNEL WITH & WITHOUT MASTER FADER (VERSION 1)

**Word Clock Input Connector**

This 75 ohm BNC socket is used for the word clock input, and has the following connections;

Inner: Signal.

Outer: Screen.

**AES/EBU Sync Input Connector**

This XLR 3 pin socket is used for AES/EBU Sync Input, and has the following connections;

Pin 1: Screen.

Pin 2: Phase.

Pin 3: Non-phase.

**Channel Options, Jumper Settings and Presets**

The PGM digital stereo output channel can be configured in a number of different ways depending on the jumper options set on the board. The on board processors software is configured by jumpers J3 to J9 and channel identifying links. The PGM digital output channel is identified by having links LK42 and LK45 fitted. The PGM digital output channel with fader is identified by having links LK42, LK45 and LK46 fitted.

The standard options available are;

- Cleanfeed mix bus termination.
- Select mode and sample rate.
- Select output sample size.
- Select channel status bits.
- Select AES/EBU or S/PDIF output.
- Select AES/EBU or S/PDIF sync input.

**Summary of Jumper Settings for the PGM Digital Output Channel**

Jumper	Set over Pins	Effect
J1	1 & 2 None	Cleanfeed 1 terminated. Cleanfeed 1 active.
J2	1 & 2 None	Cleanfeed 2 terminated. Cleanfeed 2 active.
J3-J6		See table (page 96) Synchronisation Mode & Sample Rate Selection.
J7-J8		See table (page 96) Output Bit Depth Selection.
J9		See table (page 96) Channel Status Bits Selection.
J10	<b>1 &amp; 2</b> 2 & 3	AES/EBU sync input selected. S/PDIF sync input selected.
J11	<b>1 &amp; 2</b>	AES/EBU sync input selected.
	2 & 3	S/PDIF sync input selected.
J12	1 & 2	S/PDIF output selected.
	<b>2 &amp; 3</b>	AES/EBU output selected.

**Note:** Options in bold are set as default when shipped.

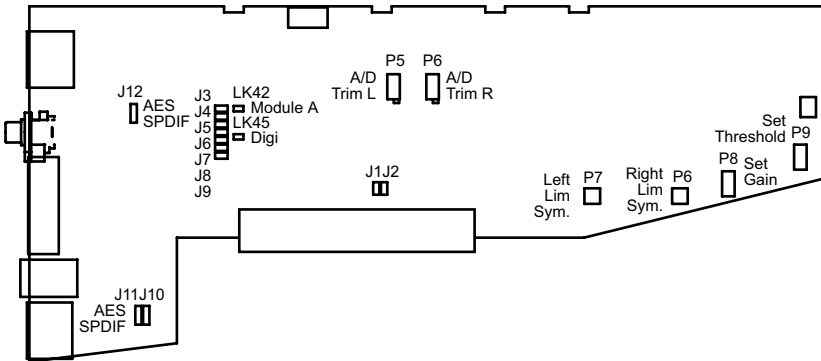

Fig 14-1 : S2 Digital PGM Output Board Layout.



**S2-ODPF/S2-ODP DIGITAL OUTPUT PGM CHANNEL WITH & WITHOUT MASTER FADER (VERSION 1)**

# 14

## S2-ODPF/S2-ODP DIGITAL OUTPUT PGM CHANNEL WITH & WITHOUT MASTER FADER (VERSION 1)



### S2-ODPF/S2-ODP DIGITAL OUTPUT PGM CHANNEL WITH & WITHOUT MASTER FADER (VERSION 1)

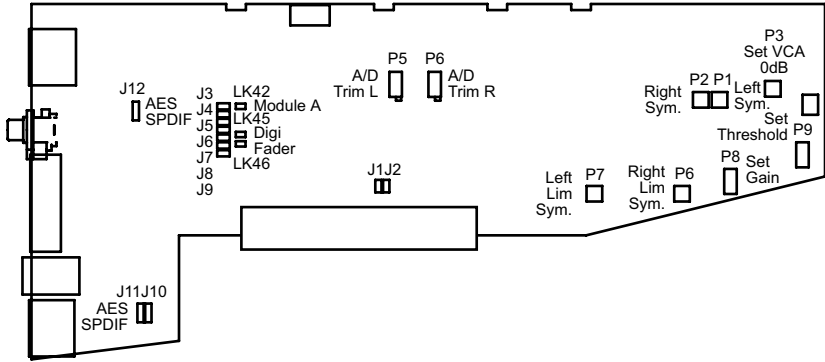

Fig 14-2: S2 Digital PGM Output With Fader Board Layout.

### Cleanfeed Terminations

If the console is supplied without Telco channels then J1 and J2 will be fitted to terminate the cleanfeed mix buses. With one Telco channel only J2 is fitted and with two Telco channels no jumpers are fitted. There is no default setting.

### Synchronisation Mode and Sample Rate

The following jumpers, J3 to J9, are used for setting the Sync Mode and Sample Rate of the digital output.

In Master mode, the digital output sample rate is simply set by, and locked to, the internal on-board clock generator. No sync signal is used or required.

In Auto mode the sample rate follows the sync input. When the sync signal is not present the sample rate will be set by, and locked to, the internal on-board clock generator at a frequency determined by the jumpers.

In Auto Lock mode, the sample rate follows the sync input. If the sync signal is removed then the sample rate will be set by, and locked to, the internal on-board clock generator at the closest frequency available to the previous sync input. When there has been no sync input detected the output will lock to the on-board clock generator at 32KHz.

In Slave mode, the sample rate follows the sync input. When the sync signal is not present the digital output is muted.

Synchronisation Mode / Sample Rate (kHz)		J3	J4	J5	J6
<b>MASTER</b>	32	Not Fitted	Not Fitted	Not Fitted	Not Fitted
	44.1	Fitted	Not Fitted	Not Fitted	Not Fitted
	<b>48</b>	<b>Not Fitted</b>	<b>Fitted</b>	<b>Not Fitted</b>	<b>Not Fitted</b>
	96	Fitted	Not Fitted	Fitted	Not Fitted
<b>AUTO</b>	32	Not Fitted	Fitted	Fitted	Not Fitted
	44.1	Fitted	Fitted	Fitted	Not Fitted
	48	Not Fitted	Not Fitted	Not Fitted	Fitted
	96	Fitted	Fitted	Not Fitted	Fitted
Auto Lock		Not Fitted	Not Fitted	Fitted	Fitted
Slave Mode		Fitted	Not Fitted	Fitted	Fitted
Reserved		Not Fitted	Fitted	Fitted	Fitted
Reserved		Fitted	Fitted	Fitted	Fitted

Output Bit Depth	J7	J8
16 bits	Not Fitted	Not Fitted
20 bits	Fitted	Not Fitted
<b>24 bits</b>	<b>Not Fitted</b>	<b>Fitted</b>
Reserved	Fitted	Fitted

Channel Status Bits	J9
Consumer	Not Fitted
<b>Professional</b>	<b>Fitted</b>

### Sync Select

The pair of jumpers, J10 and J11, select the sync source between AES, pins 1 & 2, and S/PDIF, pins 2 & 3. The default is AES/EBU. Both jumpers need to be altered for this to work correctly.

### Digital Output Mode

Jumper J12 selects the digital output mode between AES/EBU, pins 1 & 2, and S/PDIF, pins 2 & 3. The default is AES/EBU.

### Presets

Presets P1 & P2 are for altering the audio waveform symmetry (i.e. distortion) through the VCA stage. They are factory set on final test and should not be adjusted further.

Preset P3 sets the VCA fader gain to 0dB when the fader is fully open. This is preset on final test and should not require further adjustment, unless it has been found necessary to replace the fader or other VCA components.

Presets, P5 (left) and P4 (right), set the peak digits through the conditioning circuits to the analogue to digital converter. This is preset on final test and should not require further adjustment.





Preset P8 sets the gain through the limiter that feeds the analogue to digital converters. Preset P9 sets the threshold. Presets P6 & P7 are for altering the audio waveform symmetry (i.e. distortion) through the limiting stage. They are all factory set on final test and should not be adjusted further.

### ADC Calibration

For optimum performance, the module should be calibrated when it has been powered up for approximately 10-15 minutes. The circuitry and chipsets contained in the module will warm up during this time and the performance will deteriorate unless calibrated (the noise floor and dynamic range will be 1-2dB down on their best). The calibration cycle calibrates the gain and the zero reference of the A/D converter.

To calibrate, hold down the PGM button and press the AUD button 5 times. The lock LED on the front panel will flash quickly for 2 – 3 seconds and will return to it's previous state. The calibration procedure is now complete.

### Button Mode Settings

To make the S2 modules as flexible as possible, every button on each channel can be set to a number of different modes. These will aid in the use of the mixer and allow for extra functionality. To make use of these modes, you must enter a setup mode which is exactly the same for every module. It is only necessary to perform this procedure once.

To enter the setup mode, hold down the PGM and AUD buttons together for 5 seconds. After which all the buttons will start a recurring flashing sequence, at this point it is ok to release the PGM and AUD buttons. This sequence indicates the mode which each button is currently set to. One flash equals mode one, two flashes equals mode two etc. To change the mode for a particular button simply press it once and watch the number of flashes increase. Once the maximum mode number has been reached it will simply wrap around to mode one and continue as before. To exit this setup procedure press and hold both the PGM and AUD buttons as before for 2 seconds and the module will start operating as normal.

Each button and their corresponding modes are listed below.

#### PGM

- Mode 1:** Normal. The PGM bus can be selected as the mono output source as normal.
- Mode 2:** Always on. The program bus is permanently selected as the mono output source.
- Mode 3:** Always off. The program bus can never be selected as the mono output source.

#### AUD

- Mode 1:** Normal. The AUD bus can be selected as the mono output source as normal.
- Mode 2:** Always on. The audition bus is permanently selected as the mono output source.
- Mode 3:** Always off. The audition bus can never be selected as the mono output source.

**Note: If both buttons are set to mode 2 (Always on) then the mono output will be a mix of both PGM and AUD buses.**



**15 S2-ODPF/S2-ODP Digital Output PGM Channel With & Without Master Fader (Version 2)**

A change was made to the hardware and firmware of the S2-ODPF/S2-ODP modules around January 2008. Modules prior to this date are likely to be Version 1, modules after this date are likely to be Version 2. Externally, the only way to check the Version number of this module which has been fitted into your S2, is to look at the layout of the connectors on the rear panel. If the POWER and OUTPUTS AND REMOTES connector is at the bottom of the panel (see page 99), then you have a Version 2 module. If these connectors are nearer the middle of the panel (see page 92), then it is Version 1.

**Panel Controls**

**Mono Output Selection**

The Mono compatible output can be used to feed a mono transmitter or any station output monitoring system that requires a mono signal such as a background music system. The Mono output can be derived from either the PGM or AUD outputs by selecting the appropriate button.

**Lock Indicator**

The illuminated lock indicator shows that the digital output is locked to the onboard master clock, incoming Word clock or AES/EBU, S/PDIF compatible sync signal. If sync is lost then the indicator will flash. The channel automatically searches for a sync signal on the Word Clock, or the selected digital input, and automatically locks to a valid sync clock. To disable locking to the AES/EBU or S/PDIF input, simply remove jumpers J10 and J11.

**Fader (S2-ODPF only)**

The 100mm VCA fader provides unity gain when fully open.

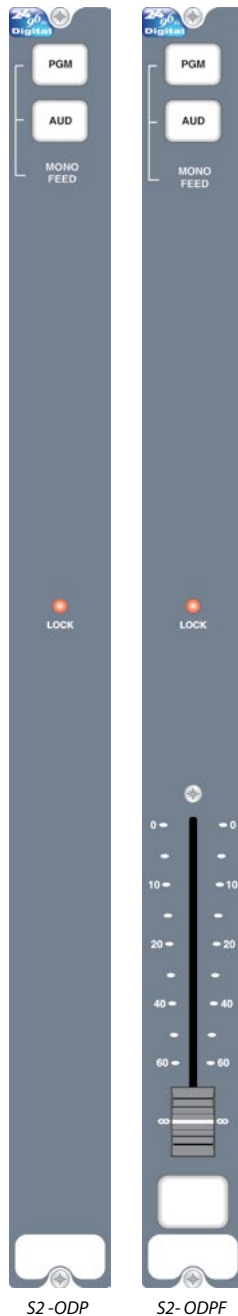

**S2-ODPF/S2-ODP DIGITAL OUTPUT PGM CHANNEL WITH & WITHOUT MASTER FADER (VERSION 2)**



## Rear Panel

### AES/EBU PGM Output Connector

This XLR 3 pin plug is used for the AES/EBU Output, and has the following connections;

- Pin 1: Screen.
- Pin 2: Phase.
- Pin 3: Non-phase.

### S/PDIF PGM Output Connector

This phono connector is used for S/PDIF output. There are on board jumpers to set up this input in place of the AES/EBU output.

- Inner: Signal.
- Outer: Screen.

### S/PDIF Sync Input Connector

This phono connector is used for the S/PDIF sync input. There is an on board jumper to set up this input in place of the AES/EBU sync input.

- Inner: Signal.
- Outer: Screen.

### Outputs & Remotes Connector

This 15 pin D type socket provides outputs for the following channel functions;

- PGM analogue outputs
- Mono analogue output
- Control Room muting relays. The mute relay is a double pole relay, 2A at 30VDC max

The connector pin-out is as follows;

- Pin 1: Chassis ground.
- Pin 2: PGM left output phase.
- Pin 3: PGM right output phase.
- Pin 4: No connection.
- Pin 5: No connection.
- Pin 6: Mono output phase.
- Pin 7: Control Room mute relay contact 1A (makes to pin 14).
- Pin 8: Control Room mute relay contact 2A (makes to pin 15).
- Pin 9: PGM left output non-phase.
- Pin 10: PGM right output non-phase.
- Pin 11: No connection.
- Pin 12: No connection.
- Pin 13: Mono output non-phase.
- Pin 14: Control Room mute relay contact 1B.
- Pin 15: Control Room mute relay contact 2B.

### Word Clock Input Connector

This 75 ohm BNC socket is used for the word clock input, and has the following connections;

Inner: Signal.  
Outer: Screen.

### AES/EBU Sync Input Connector

This XLR 3 pin socket is used for AES/EBU Sync Input, and has the following connections;

Pin 1: Screen.  
Pin 2: Phase.  
Pin 3: Non-phase.

### Channel Options, Jumper Settings and Presets

The PGM digital stereo output channel can be configured in a number of different ways depending on the jumper options set on the board. The on board processors software is configured by jumpers J3 to J9 and channel identifying links. The PGM digital output channel is identified by having links LK42 and LK45 fitted. The PGM digital output channel with Fader is identified by having links LK42, LK45 and LK46 fitted.

The standard options available are;

- Cleanfeed mix bus termination.
- Select mode and sample rate.
- Select channel status bits.
- Select AES/EBU or S/PDIF output.
- Select AES/EBU or S/PDIF sync input.





## Summary of Jumper Settings for the PGM Digital Output Channel

Jumper	Set over Pins	Effect
J1	1 & 2 None	Cleanfeed 1 terminated. Cleanfeed 1 active.
J2	1 & 2 None	Cleanfeed 2 terminated. Cleanfeed 2 active.
J3-J6		See table (page 103) Synchronisation Mode & Sample Rate Selection.
J7-J8		Reserved.
J9		See table (page 103) Channel Status Bits Selection.
J10	<b>1 &amp; 2</b> 2 & 3	AES/EBU sync input selected. S/PDIF sync input selected.
J11	<b>1 &amp; 2</b>	AES/EBU sync input selected.
	2 & 3	S/PDIF sync input selected.
J12	1 & 2	S/PDIF output selected.
	<b>2 &amp; 3</b>	AES/EBU output selected.
J13	1&2 <b>None</b>	Reserved. Reserved.

Note: Options in **bold** are set as default when shipped.

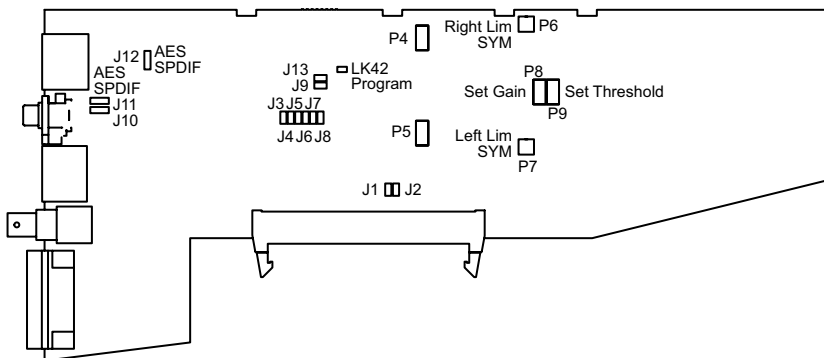

Fig 15-1: S2 Digital PGM Output Board Layout.

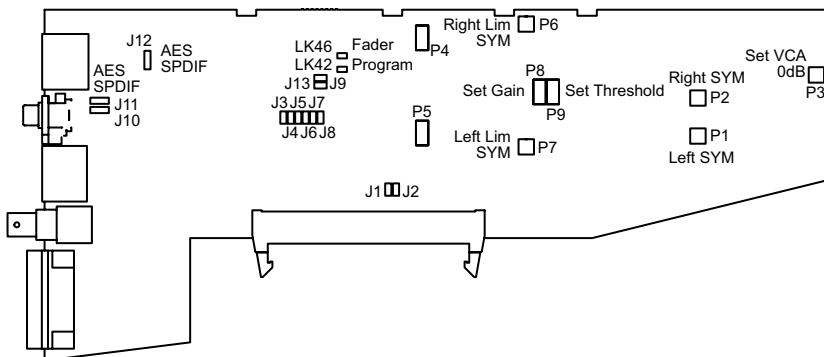

Fig 15-2: S2 Digital PGM Output With Fader Board Layout.

**Cleanfeed Terminations**

If the console is supplied without Telco channels then J1 and J2 will be fitted to terminate the cleanfeed mix buses. With one Telco channel only J2 is fitted and with two Telco channels no jumpers are fitted. There is no default setting.

**Synchronisation Mode and Sample Rate**

The following jumpers, J3 to J6 and J9 on V2, are used for setting the Sync Mode and Sample Rate of the digital output.

In Master mode, the digital output sample rate is simply set by, and locked to, the internal on-board clock generator. No sync signal is used or required.

In Auto mode the sample rate follows the sync input. When the sync signal is not present the sample rate will be set by, and locked to, the internal on-board clock generator at a frequency determined by the jumpers.





In Auto Lock mode, the sample rate follows the sync input. If the sync signal is removed then the sample rate will be set by, and locked to, the internal on-board clock generator at the closest frequency available to the previous sync input. When there has been no sync input detected the output will lock to the on-board clock generator at 32kHz.

In Slave mode, the sample rate follows the sync input. When the sync signal is not present the digital output is muted.

Synchronisation Mode / Sample Rate (kHz)		J3	J4	J5	J6
<b>MASTER</b>	32	Not Fitted	Not Fitted	Not Fitted	Not Fitted
	44.1	Fitted	Not Fitted	Not Fitted	Not Fitted
	<b>48</b>	<b>Not Fitted</b>	<b>Fitted</b>	<b>Not Fitted</b>	<b>Not Fitted</b>
	96	Fitted	Not Fitted	Fitted	Not Fitted
<b>AUTO</b>	32	Not Fitted	Fitted	Fitted	Not Fitted
	44.1	Fitted	Fitted	Fitted	Not Fitted
	48	Not Fitted	Not Fitted	Not Fitted	Fitted
	96	Fitted	Fitted	Not Fitted	Fitted
Auto Lock		Not Fitted	Not Fitted	Fitted	Fitted
Slave Mode		Fitted	Not Fitted	Fitted	Fitted

Channel Status Bits	J9
Consumer	Not Fitted
<b>Professional</b>	<b>Fitted</b>

### Sync Select

The pair of jumpers, J10 and J11, select the sync source between AES, pins 1 & 2, and S/PDIF, pins 2 & 3. The default is AES/EBU. Both jumpers need to be altered for this to work correctly.

### Digital Output Mode

Jumper J12 selects the digital output mode between AES/EBU, pins 1 & 2, and S/PDIF, pins 2 & 3. The default is AES/EBU.

### Presets

Presets P1 & P2 are for altering the audio waveform symmetry (i.e. distortion) through the VCA stage. They are factory set on final test and should not be adjusted further.

Preset P3 sets the VCA fader gain to 0dB when the fader is fully open. This is preset on final test and should not require further adjustment, unless it has been found necessary to replace the fader or other VCA components.

Presets, P5 (left) and P4 (right), set the peak digits through the conditioning circuits to the analogue to digital converter. This is preset on final test and should not require further adjustment.

Preset P8 sets the gain through the limiter that feeds the analogue to digital converters. Preset P9 sets the threshold. Presets P6 & P7 are for altering the audio waveform symmetry (i.e. distortion) through the limiting stage. They are all factory set on final test and should not be adjusted further.

### Button Mode Settings

To make the S2 modules as flexible as possible, every button on each channel can be set to a number of different modes. These will aid in the use of the mixer and allow for extra functionality. To make use of these modes, you must enter a setup mode which is exactly the same for every module. It is only necessary to perform this procedure once.

To enter the setup mode, hold down the PGM and AUD buttons together for 5 seconds. After which all the buttons will start a recurring flashing sequence, at this point it is ok to release the PGM and AUD buttons. This sequence indicates the mode which each button is currently set to. One flash equals mode one, two flashes equals mode two etc. To change the mode for a particular button simply press it once and watch the number of flashes increase. Once the maximum mode number has been reached it will simply wrap around to mode one and continue as before. To exit this setup procedure press and hold both the PGM and AUD buttons as before for 2 seconds and the module will start operating as normal.

Each button and their corresponding modes are listed below.

#### PGM

**Mode 1:** Normal. The PGM bus can be selected as the mono output source as normal.

**Mode 2:** Always on. The program bus is permanently selected as the mono output source.

**Mode 3:** Always off. The program bus can never be selected as the mono output source.

#### AUD

**Mode 1:** Normal. The AUD bus can be selected as the mono output source as normal.

**Mode 2:** Always on. The audition bus is permanently selected as the mono output source.

**Mode 3:** Always off. The audition bus can never be selected as the mono output source.

**Note: If both buttons are set to mode 2 (Always on) then the mono output will be a mix of both PGM and AUD buses.**





## S2-ODAF/S2-ODA DIGITAL OUTPUT AUD CHANNEL WITH & WITHOUT MASTER FADER (VERSION 1)

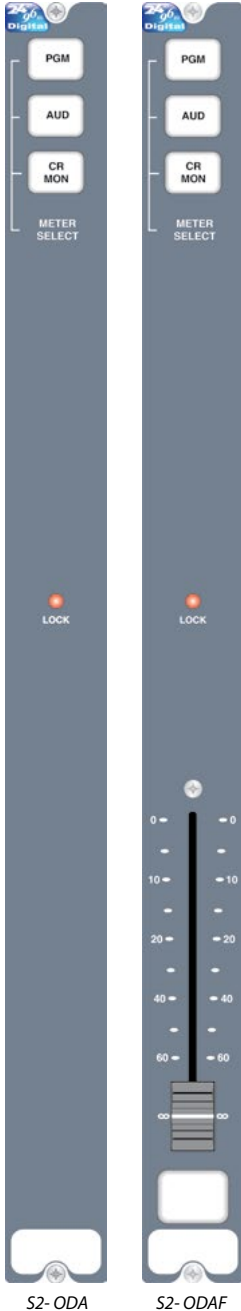

S2- ODA

S2- ODAF

### 16 S2-ODAF/S2-ODA Digital Output AUD Channel With & Without Master Fader (Version 1)

A change was made to the hardware and firmware of the S2-ODAF/S2-ODA modules around January 2008. Modules prior to this date are likely to be Version 1, modules after this date are likely to be Version 2. Externally, the only way to check the Version number of this module which has been fitted into your S2, is to look at the layout of the connectors on the rear panel. If the OUTPUTS AND REMOTES connector is at the bottom of the panel (see page 113), then you have a Version 2 module. If these connectors are nearer the middle of the panel (see page 106), then it is Version 1.

#### Panel Controls

##### Meter Display Selection

When the meters in the meterbridge are plugged up to the “Monitor Meter” position they will display the selected signal from the electronically interlocking PGM, AUD, or CR MON buttons. The CR MON signal source is the presenter’s headphone on the control room monitor channel, pre talkback and level control. This signal could be PGM, AUD, EXT 1, EXT 2, or PFL, as selected by the presenter.

##### Lock Indicator

The illuminated lock indicator shows that the digital output is locked to the onboard master clock, incoming Word clock or AES/EBU, S/PDIF compatible sync signal. If sync is lost then the indicator will flash. The channel automatically searches for a sync signal on the Word Clock, or the selected digital input, and automatically locks to a valid sync clock. To disable locking to the AES/EBU or S/PDIF input, simply remove jumpers J10 and J11.

##### Fader (S2-ODAF only)

The 100mm VCA fader provides unity gain when fully open.





## Rear Panel

### AES/EBU AUD Output Connector

This XLR 3 pin socket is used for the AES/EBU Output, and has the following connections;

- Pin 1: Screen.
- Pin 2: Phase.
- Pin 3: Non-phase.

### S/PDIF AUD Output Connector

This phono connector is used for the S/PDIF Output. There are on board jumpers to set up this output in place of the AES/EBU output.

- Inner: Signal.
- Outer: Screen.

### S/PDIF Sync Input Connector

This phono connector is used for the S/PDIF sync input. There is an on board jumper to set up this input in place of the AES/EBU sync input.

- Inner: Signal.
- Outer: Screen.

### Output & Remotes Connector

This 15 pin D type socket provides outputs for the following channel functions;

- AUD analogue outputs
- Studio muting relays. The mute relay is a double pole relay, 2A at 30VDC max

The connector pin-out is as follows;

- Pin 1: Chassis ground.
- Pin 2: AUD left output phase.
- Pin 3: AUD right output phase.
- Pin 4: No connection.
- Pin 5: No connection.
- Pin 6: No connection.
- Pin 7: Studio mute relay contact 1A (makes to pin 14).
- Pin 8: Studio mute relay contact 2A (makes to pin 15).
- Pin 9: AUD left output non-phase.
- Pin 10: AUD right output non-phase.
- Pin 11: No connection.
- Pin 12: No connection.
- Pin 13: No connection.
- Pin 14: Studio mute relay contact 1B.
- Pin 15: Studio mute relay contact 2B.



S2-ODAF/S2-ODA DIGITAL OUTPUT AUD CHANNEL  
WITH & WITHOUT MASTER FADER (VERSION 1)



### Meterbridge Interconnect

An internal ribbon cable to the meterbridge is fitted to the AUD output channel and appears via the rear panel.

### Word Clock Input Connector

This 75 ohm BNC socket is used for the word clock input, and has the following connections;

Inner: Signal.

Outer: Screen.

### AES/EBU Sync Input Connector

This XLR 3 pin socket is used for AES/EBU Sync Input, and has the following connections;

Pin 1: Screen.

Pin 2: Phase.

Pin 3: Non-phase.

### Channel Options, Jumper Settings and Presets

The AUD digital stereo output channel can be configured in a number of different ways depending on the jumper options set on the board. The on-board processor's software is configured by jumpers J3 to J9 and channel identifying links. The AUD digital output channel is identified by having links LK43 and LK45 fitted. The AUD digital output with fader is identified by having links LK43, LK45 and LK46 fitted.

The standard options available are;

- Select mode and sample rate.
- Select output sample size.
- Select channel status bits.
- Select AES/EBU or S/PDIF output.
- Select AES/EBU or S/PDIF sync input.

**Summary of Jumper Settings for the AUD Digital Output Channel**

Jumper	Set over Pins	Effect
J1	Not Fitted	
J2	Not Fitted	
J3-J6		See table (page 109) Synchronisation Mode & Sample Rate Selection.
J7-J8		See table (page 110) Output Bit Depth Selection.
J9		See table (page 110) Channel Status Bits Selection.
J10	<b>1 &amp; 2</b> 2 & 3	AES/EBU sync input selected. S/PDIF sync input selected.
J11	<b>1 &amp; 2</b>	AES/EBU sync input selected.
	2 & 3	S/PDIF sync input selected.
J12	1 & 2	S/PDIF output selected.
	<b>2 &amp; 3</b>	AES/EBU output selected.

Note: Options in bold are set as default when shipped.

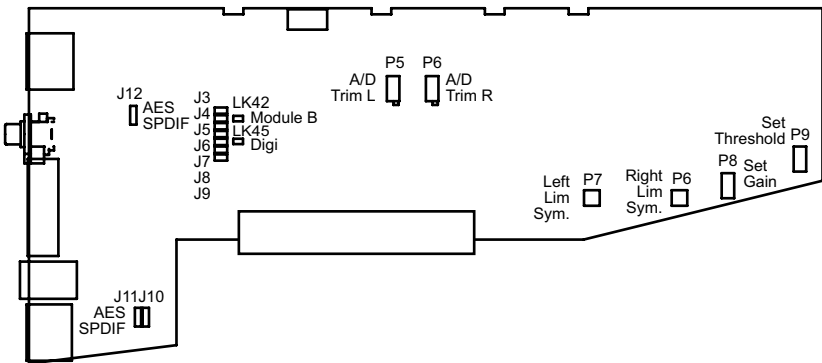

Fig 16-1 : S2 Digital AUD Output Board Layout.



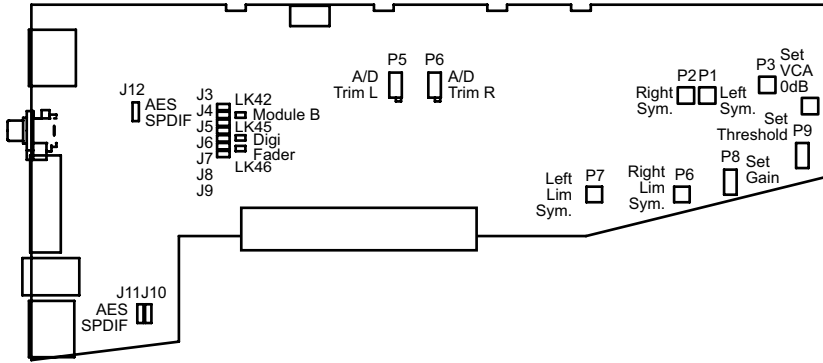

Fig 16-2 : S2 Digital AUD Output With Fader Board Layout.

### Synchronisation Mode and Sample Rate

The following jumpers, J3 to J9, are used for setting the Sync Mode and Sample Rate of the digital output.

In Master mode, the digital output sample rate is simply set by, and locked to, the internal on-board clock generator. No sync signal is used or required.

In Auto mode the sample rate follows the sync input. When the sync signal is not present the sample rate will be set by, and locked to, the internal on-board clock generator at a frequency determined by the jumpers.

In Auto Lock mode, the sample rate follows the sync input. If the sync signal is removed then the sample rate will be set by, and locked to, the internal on-board clock generator at the closest frequency available to the previous sync input. When there has been no sync input detected the output will lock to the on-board clock generator at 32kHz.

In Slave mode, the sample rate follows the sync input. When the sync signal is not present the digital output is muted.

Synchronisation Mode / Sample Rate (kHz)		J3	J4	J5	J6
MASTER	32	Not Fitted	Not Fitted	Not Fitted	Not Fitted
	44.1	Fitted	Not Fitted	Not Fitted	Not Fitted
	<b>48</b>	<b>Not Fitted</b>	<b>Fitted</b>	<b>Not Fitted</b>	<b>Not Fitted</b>
	96	Fitted	Not Fitted	Fitted	Not Fitted
AUTO	32	Not Fitted	Fitted	Fitted	Not Fitted
	44.1	Fitted	Fitted	Fitted	Not Fitted
	48	Not Fitted	Not Fitted	Not Fitted	Fitted
	96	Fitted	Fitted	Not Fitted	Fitted
Auto Lock	Not Fitted	Not Fitted	Fitted	Fitted	
Slave Mode	Fitted	Not Fitted	Fitted	Fitted	
Reserved	Not Fitted	Fitted	Fitted	Fitted	
Reserved	Fitted	Fitted	Fitted	Fitted	

Output Bit Depth	J7	J8
16 bits	Not Fitted	Not Fitted
20 bits	Fitted	Not Fitted
<b>24 bits</b>	<b>Not Fitted</b>	<b>Fitted</b>
Reserved	Fitted	Fitted

Channel Status Bits	J9
Consumer	Not Fitted
<b>Professional</b>	<b>Fitted</b>



### Sync Select

The pair of jumpers, J10 and J11, select the sync source between AES, pins 1 & 2, and S/PDIF, pins 2 & 3. The default is AES/EBU. Both jumpers need to be altered for this to work correctly.

### Digital Output Mode

Jumper J12 selects the digital output mode between AES/EBU, pins 1 & 2, and S/PDIF, pins 2 & 3. The default is AES/EBU.

### Presets

Presets P1 & P2 are for altering the audio waveform symmetry (i.e. distortion) through the VCA stage. They are factory set on final test and should not be adjusted further.

Preset P3 sets the VCA fader gain to 0dB when the fader is fully open. This is preset on final test and should not require further adjustment, unless it has been found necessary to replace the fader or other VCA components.

Presets, P5 (left) and P4 (right), set the peak digits through the conditioning circuits to the analogue to digital converter. This is preset on final test and should not require further adjustment.

Preset P8 sets the gain through the limiter that feeds the analogue to digital converters. Preset P9 sets the threshold. Presets P6 & P7 are for altering the audio waveform symmetry (i.e. distortion) through the limiting stage. They are all factory set on final test and should not be adjusted further.

Gain can be altered using P4 and P5 on board versions S2-OP-04 and above, as P8 is no longer fitted on these boards.

### ADC Calibration

For optimum performance, the module should be calibrated when it has been powered up for approximately 10-15 minutes. The circuitry and chipsets contained in the module will warm up during this time and the performance will deteriorate unless calibrated (the noise floor and dynamic range will be 1-2dB down on their best). The calibration cycle calibrates the gain and the zero reference of the A/D converter.



To calibrate, hold down the PGM button and press the AUD button 5 times. The lock LED on the front panel will flash quickly for 2 – 3 seconds and will return to its previous state. The calibration procedure is now complete.

### Button Mode Settings

To make the S2 modules as flexible as possible, every button on each channel can be set to a number of different modes. These will aid in the use of the mixer and allow for extra functionality. To make use of these modes, you must enter a setup mode which is exactly the same for every module. It is only necessary to perform this procedure once.

To enter the setup mode, hold down the PGM and AUD buttons together for 5 seconds. After which all the buttons will start a recurring flashing sequence, at this point it is ok to release the PGM and AUD buttons. This sequence indicates the mode which each button is currently set to. One flash equals mode one, two flashes equals mode two etc. To change the mode for a particular button simply press it once and watch the number of flashes increase. Once the maximum mode number has been reached it will simply wrap around to mode one and continue as before. To exit this setup procedure press and hold both the PGM and AUD buttons as before for 2 seconds and the module will start operating as normal.

Each button and their corresponding modes are listed below.

#### PGM

**Mode 1** : Normal. PGM can be selected as the meter feeder as normal.

**Mode 2** : Always on. PGM is permanently selected as the meter feed.

**Mode 3** : Always off. PGM can never be selected as the meter feed.

#### AUD

**Mode 1** : Normal. AUD can be selected as the meter feeder as normal.

**Mode 2** : Always on. AUD is permanently selected as the meter feed.

**Mode 3** : Always off. AUD can never be selected as the meter feed.

#### CR MON

**Mode 1** : Normal. The Control Room Monitor channel be selected as the meter feed as normal.

**Mode 2** : Always on. The Control Room Monitor channel is permanently selected as the meter feed.

**Mode 3** : Always off. The Control Room Monitor channel can never be selected as the meter feed.

**Note: If more than one button is set to mode 2 (Always on) then the meter feed will be a mix of these sources. This may not be desirable in most applications.**

## 17 S2-ODAF/S2-ODA Digital Output AUD Channel With & Without Master Fader (Version 2)

A change was made to the hardware and firmware of the S2-ODAF/S2-ODA modules around January 2008. Modules prior to this date are likely to be Version 1, modules after this date are likely to be Version 2. Externally, the only way to check the Version number of this module which has been fitted into your S2, is to look at the layout of the connectors on the rear panel. If the OUTPUTS AND REMOTES connector is at the bottom of the panel (see page 113), then you have a Version 2 module. If these connectors are nearer the middle of the panel (see page 106), then it is Version 1.

### Panel Controls

#### Meter Display Selection

When the meters in the meterbridge are plugged up to the "Monitor Meter" position they will display the selected signal from the electronically interlocking PGM, AUD, or CR MON buttons. The CR MON signal source is the presenter's headphone on the control room monitor channel, pre talkback and level control. This signal could be PGM, AUD, EXT 1, EXT 2, or PFL, as selected by the presenter.

#### Lock Indicator

The illuminated lock indicator shows that the digital output is locked to the onboard master clock, incoming Word clock or AES/EBU, S/PDIF compatible sync signal. If sync is lost then the indicator will flash. The channel automatically searches for a sync signal on the Word Clock, or the selected digital input, and automatically locks to a valid sync clock. To disable locking to the AES/EBU or S/PDIF input, simply remove jumpers J10 and J11.

#### Fader (S2-ODAF only)

The 100mm VCA fader provides unity gain when fully open.

### Rear Panel

#### AES/EBU AUD Output Connector

This XLR 3 pin socket is used for the AES/EBU Output, and has the following connections;

- Pin 1: Screen.
- Pin 2: Phase.
- Pin 3: Non-phase.

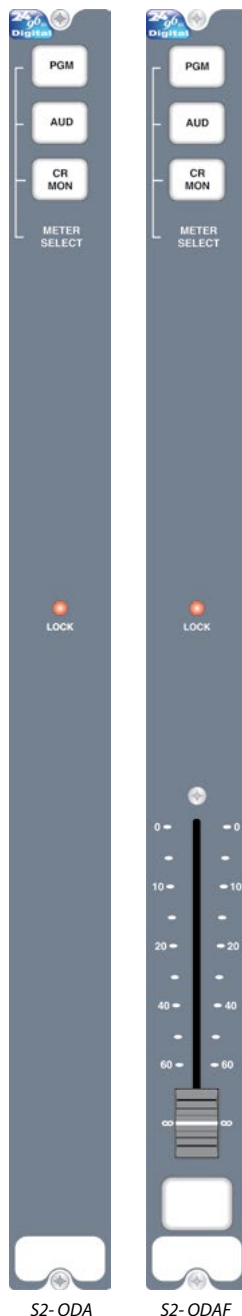

S2-ODAF/S2-ODA DIGITAL OUTPUT AUD CHANNEL WITH & WITHOUT MASTER FADER (VERSION 2)



### S/PDIF AUD Output Connector

This phono connector is used for the S/PDIF Output. There are on board jumpers to set up this output in place of the AES/EBU output.

Inner: Signal.

Outer: Screen.

### S/PDIF Sync Input Connector

This phono connector is used for the S/PDIF sync input. There is an on board jumper to set up this input in place of the AES/EBU sync input.

Inner: Signal.

Outer: Screen.

### Output & Remotes Connector

This 15 pin D type socket provides outputs for the following channel functions;

- AUD analogue outputs
- Studio muting relays. The mute relay is a double pole relay, 2A at 30VDC max

The connector pin-out is as follows;

- Pin 1: Chassis ground.
- Pin 2: AUD left output phase.
- Pin 3: AUD right output phase.
- Pin 4: No connection.
- Pin 5: No connection.
- Pin 6: No connection.
- Pin 7: Studio mute relay contact 1A (makes to pin 14).
- Pin 8: Studio mute relay contact 2A (makes to pin 15).
- Pin 9: AUD left output non-phase.
- Pin 10: AUD right output non-phase.
- Pin 11: No connection.
- Pin 12: No connection.
- Pin 13: No connection.
- Pin 14: Studio mute relay contact 1B.
- Pin 15: Studio mute relay contact 2B.

### Meterbridge Interconnect

An internal ribbon cable to the meterbridge is fitted to the AUD output channel and appears via the rear panel.

### Word Clock Input Connector

This 75 ohm BNC socket is used for the word clock input, and has the following connections;

Inner: Signal.

Outer: Screen.

### AES/EBU Sync Input Connector

This XLR 3 pin socket is used for AES/EBU Sync Input, and has the following connections;





- Pin 1: Screen.
- Pin 2: Phase.
- Pin 3: Non-phase.

### Channel Options, Jumper Settings and Presets

The AUD digital stereo output channel can be configured in a number of different ways depending on the jumper options set on the board. The on-board processor's software is configured by jumpers J3 to J9 and channel identifying links. The AUD digital output channel is identified by having links LK43 and LK45 fitted. The AUD digital output with fader is identified by having links LK43, LK45 and LK46 fitted.

The standard options available are;

- Select mode and sample rate.
- Select channel status bits.
- Select AES/EBU or S/PDIF output.
- Select AES/EBU or S/PDIF sync input.

#### Summary of Jumper Settings for the AUD Digital Output Channel

Jumper	Set over Pins	Effect
J1	Not Fitted	
J2	Not Fitted	
J3-J6		See table (page 116) Synchronisation Mode & Sample Rate Selection.
J7-J8		Reserved.
J9		See table (page 116) Channel Status Bits Selection.
J10	<b>1 &amp; 2</b>	AES/EBU sync input selected.
	2 & 3	S/PDIF sync input selected.
J11	<b>1 &amp; 2</b>	AES/EBU sync input selected.
	2 & 3	S/PDIF sync input selected.
J12	1 & 2	S/PDIF output selected.
	<b>2 &amp; 3</b>	AES/EBU output selected.
J13	1&2	Reserved.
	<b>None</b>	Reserved.

**Note: Options in bold are set as default when shipped.**



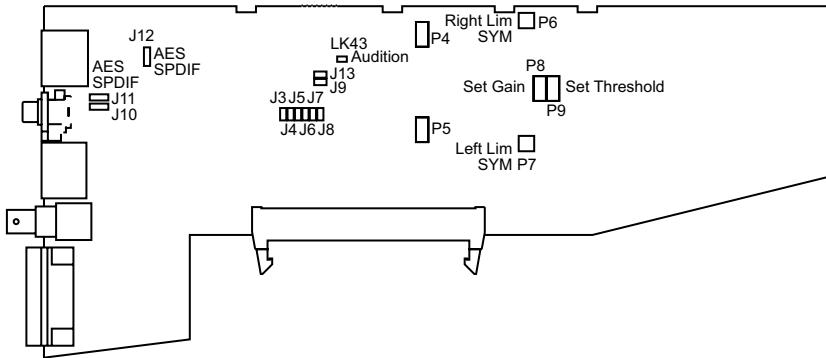

Fig 17-1: S2 Digital AUD Output Board Layout.

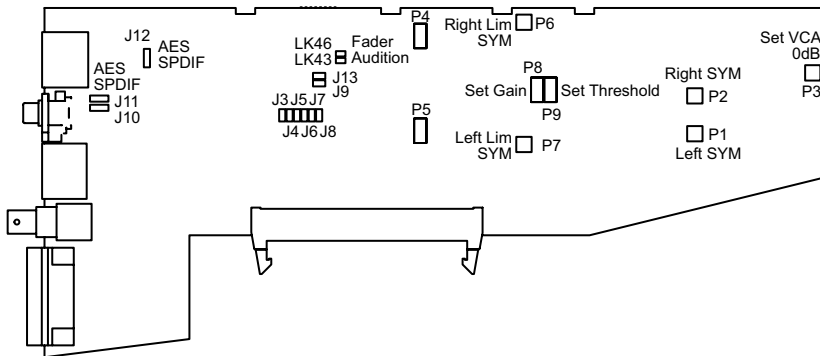

Fig 17-2: S2 Digital AUD Output With Fader Board Layout.

### Synchronisation Mode and Sample Rate

The following jumpers, J3 to J6 and J9 on V2, are used for setting the Sync Mode and Sample Rate of the digital output.

In Master mode, the digital output sample rate is simply set by, and locked to, the internal on-board clock generator. No sync signal is used or required.

In Auto mode the sample rate follows the sync input. When the sync signal is not present the sample rate will be set by, and locked to, the internal on-board clock generator at a frequency determined by the jumpers.

In Auto Lock mode, the sample rate follows the sync input. If the sync signal is removed then the sample rate will be set by, and locked to, the internal on-board clock generator at the closest frequency available to the previous sync input. When there has been no sync input detected the output will lock to the on-board clock generator at 32kHz.

In Slave mode, the sample rate follows the sync input. When the sync signal is not present the digital output is muted.

Synchronisation Mode / Sample Rate (kHz)		J3	J4	J5	J6
<b>MASTER</b>	32	Not Fitted	Not Fitted	Not Fitted	Not Fitted
	44.1	Fitted	Not Fitted	Not Fitted	Not Fitted
	<b>48</b>	<b>Not Fitted</b>	<b>Fitted</b>	<b>Not Fitted</b>	<b>Not Fitted</b>
	96	Fitted	Not Fitted	Fitted	Not Fitted
<b>AUTO</b>	32	Not Fitted	Fitted	Fitted	Not Fitted
	44.1	Fitted	Fitted	Fitted	Not Fitted
	48	Not Fitted	Not Fitted	Not Fitted	Fitted
	96	Fitted	Fitted	Not Fitted	Fitted
Auto Lock		Not Fitted	Not Fitted	Fitted	Fitted
Slave Mode		Fitted	Not Fitted	Fitted	Fitted

Channel Status Bits	J9
Consumer	Not Fitted
<b>Professional</b>	<b>Fitted</b>

### Sync Select

The pair of jumpers, J10 and J11, select the sync source between AES, pins 1 & 2, and S/PDIF, pins 2 & 3. The default is AES/EBU. Both jumpers need to be altered for this to work correctly.

### Digital Output Mode

Jumper J12 selects the digital output mode between AES/EBU, pins 1 & 2, and S/PDIF, pins 2 & 3. The default is AES/EBU.

### Presets

Presets P1 & P2 are for altering the audio waveform symmetry (i.e. distortion) through the VCA stage. They are factory set on final test and should not be adjusted further.

Preset P3 sets the VCA fader gain to 0dB when the fader is fully open. This is preset on final test and should not require further adjustment, unless it has been found necessary to replace the fader or other VCA components.





Presets, P5 (left) and P4 (right), set the peak digits through the conditioning circuits to the analogue to digital converter. This is preset on final test and should not require further adjustment.

Preset P8 sets the gain through the limiter that feeds the analogue to digital converters. Preset P9 sets the threshold. Presets P6 & P7 are for altering the audio waveform symmetry (i.e. distortion) through the limiting stage. They are all factory set on final test and should not be adjusted further.

Gain can be altered using P4 and P5 on board versions S2-OP-04 and above, as P8 is no longer fitted on these boards.

### Button Mode Settings

To make the S2 modules as flexible as possible, every button on each channel can be set to a number of different modes. These will aid in the use of the mixer and allow for extra functionality. To make use of these modes, you must enter a setup mode which is exactly the same for every module. It is only necessary to perform this procedure once.

To enter the setup mode, hold down the PGM and AUD buttons together for 5 seconds. After which all the buttons will start a recurring flashing sequence, at this point it is ok to release the PGM and AUD buttons. This sequence indicates the mode which each button is currently set to. One flash equals mode one, two flashes equals mode two etc. To change the mode for a particular button simply press it once and watch the number of flashes increase. Once the maximum mode number has been reached it will simply wrap around to mode one and continue as before. To exit this setup procedure press and hold both the PGM and AUD buttons as before for 2 seconds and the module will start operating as normal.

Each button and their corresponding modes are listed below.

#### PGM

**Mode 1 :** Normal. PGM can be selected as the meter feeder as normal.

**Mode 2 :** Always on. PGM is permanently selected as the meter feed.

**Mode 3 :** Always off. PGM can never be selected as the meter feed.

#### AUD

**Mode 1 :** Normal. AUD can be selected as the meter feeder as normal.

**Mode 2 :** Always on. AUD is permanently selected as the meter feed.

**Mode 3 :** Always off. AUD can never be selected as the meter feed.

#### CR MON

**Mode 1 :** Normal. The Control Room Monitor channel be selected as the meter feed as normal.

**Mode 2 :** Always on. The Control Room Monitor channel is permanently selected as the meter feed.

**Mode 3 :** Always off. The Control Room Monitor channel can never be selected as the meter feed.

**Note: If more than one button is set to mode 2 (Always on) then the meter feed will be a mix of these sources. This may not be desirable in most applications.**



# 18 S2-OMC CONTROL ROOM MONITOR CHANNEL



S2-ODAF/S2-ODA DIGITAL OUTPUT AUD CHANNEL WITH & WITHOUT MASTER FADER (VERSION 2)

## 18 S2-OMC Control Room Monitor Channel

### Panel Controls

#### PGM, AUD, EXT 1 & EXT 2 Selection

The electronically interlocking PGM, AUD, EXT 1 & EXT 2 buttons select the monitor source for the control room headphones and loudspeaker monitors. The buttons illuminate to show the selected source, PGM and AUD in green, EXT 1 and EXT 2 in red. The External Inputs are used for monitoring an off air signal or another studio output.

#### Monitor level

The control room monitor loudspeaker level can be variable between 0 (cut off) and 10 (maximum). The output will need to be fed to a suitable power amplifier to drive the loudspeakers.

#### Monitor Auto Cue/PFL

When the yellow illuminated AUTO CUE/PFL button is selected, any input channels selected to CUE/PFL are automatically routed to the control room monitor loudspeakers.

#### Mute

The red mute LED will illuminate whenever a mic channel, which has been designated to Control Room mute, goes live. This will mute the control room monitors to prevent feedback. Two pairs of contacts on the remote connector of the PGM output channel will close whenever the mute function is active. These can be used to remotely illuminate "Mic Live" lights.

#### Phones

The control room headphone level can be varied between 0 (cut off) and 10 (maximum). Internal amplifiers provide enough drive for headphone impedances of 35 ohms and above.

#### Phones Auto Cue/PFL

When the yellow illuminated AUTO CUE/PFL button is selected, any input channels selected to CUE/PFL are automatically routed to the control room headphones.

#### Phones Split Cue/PFL

The control room headphones have the additional facility of SPLIT CUE/PFL. When this button is selected, the monitor source will be heard in mono in the left headphone, and CUE/PFL will be heard in mono in the right headphone. The button is illuminated yellow when selected.

#### Control Room Phones

The control room headphones may be plugged into this standard 6.35mm stereo jack socket or the parallel jack socket on the rear panel.



S2-OMC



## Rear Panel

### External Inputs Connector

This 9 pin D type plug is used for the stereo balanced analogue external input signals.

The connector pin-out is as follows;

- Pin 1: Chassis ground.
- Pin 2: Ext 1 left phase.
- Pin 3: Ext 1 right phase.
- Pin 4: Ext 2 left phase.
- Pin 5: Ext 2 right phase.
- Pin 6: Ext 1 left non-phase.
- Pin 7: Ext 1 right non-phase.
- Pin 8: Ext 2 left non-phase.
- Pin 9: Ext 2 right non-phase.

### Presenter Headphones Connector

This standard 6.35mm jack socket is used for the control room headphones. It is wired in parallel with the headphone connector on the front panel and has the following connections;

- Tip: Left channel.
- Ring: Right channel.
- Sleeve: Screen.

### Control Room Monitors Connector

This standard 6.35mm jack socket is the output for the control room monitor loudspeakers, and has the following connections;

- Tip: Left channel.
- Ring: Right channel.
- Sleeve: Screen.

A suitable amplifier should be used to send this signal to the loudspeakers, or connect active loudspeakers directly to this output.

### Talkback Input Connector

This standard 6.35mm jack socket is used for the Reverse Talkback input, and has the following connections;

- Tip: Talkback audio.
- Ring: Talkback control.
- Sleeve: Screen.

### Talkback Output Connector

This standard 6.35mm jack socket is used for the continuous talkback output, and has the following connections;

- Tip: Talkback audio.
- Ring: No connection.
- Sleeve: Screen.



# 18 S2-OMC CONTROL ROOM MONITOR CHANNEL



S2-OMC CONTROL ROOM MONITOR CHANNEL

## Channel Options and Jumper Settings

The control room monitor channel can be configured in a number of different ways depending on the jumper options set on the board. The on-board processor's software is configured by jumpers J1 to J4 and channel identifying links. The control room monitor is identified by having link LK10 fitted.

The standard options available are;

- Enable/disable global talkback.
- Enable/disable talkback to loudspeakers.
- Enable/disable talkback dimming on loudspeakers.
- Enable/disable talkback dimming on headphones.

### Summary of Jumper Settings for the Control Room Monitor Channel

Jumper	Set over Pins	Effect
J1	1 & 2 <b>None</b>	Global talkback enabled. Global talkback disabled.
J2	<b>1 &amp; 2</b> None	Control Room Loudspeaker talkback enabled. Control Room Loudspeaker talkback disabled.
J3	<b>1 &amp; 2</b> None	Control Room Loudspeaker talkback dimming enabled. Control Room Loudspeaker talkback dimming disabled.
J4	1 & 2 <b>None</b>	Control Room Headphones talkback dimming enabled. Control Room Headphones talkback dimming disabled.

**Note:** Options in **bold** are set as default when shipped.

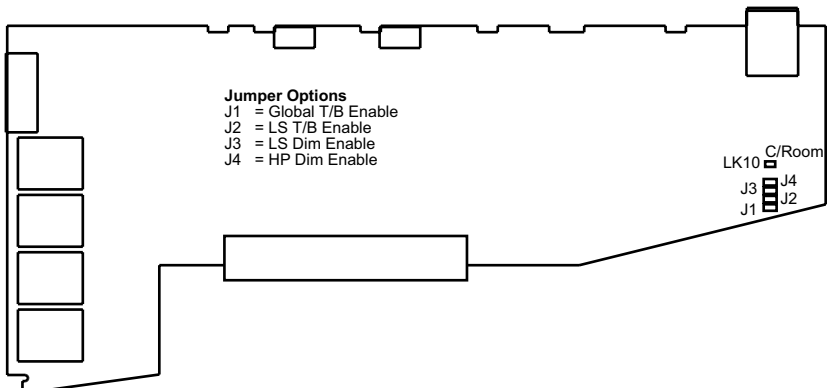

Fig 18-1 : Control Room Monitor Board Layout.



### **Global Talkback Enable**

Jumper J1 placed over pins 1 & 2 enables global talkback. This is a system whereby all programme presenters, guests, etc, can talk to each other from their individual microphones via the monitoring system. When enabled, the system becomes active when the control room and studio mutes are inactive i.e. no Mic channels with mic live muting are active. The monitored source on each person's headphones will dim by  $-12\text{dB}$  and they will be able to talk and hear each other at a normal level. When a microphone channel fader is raised, triggering a mute, the system will drop back into normal monitoring. The default setting for J1 is disabled (not fitted).

### **Control Room Loudspeaker Talkback Enable**

Jumper J2 placed over pins 1 & 2 enables talkback to the control room monitor loudspeakers. This will allow a talkback audio and control signal on the talkback input jack to replace the monitored source on the loudspeaker monitors. If the monitors are already muted then talkback will be muted too. Talkback will also appear on the control room headphones as a replacement to the monitored source. The default setting for J2 is enabled.

### **Control Room Loudspeaker Talkback Dim Enable**

Jumper J3 placed across pins 1 & 2 enables talkback dimming of the control room monitor loudspeakers. With J2 and J3 enabled, incoming talkback will dim the monitored source by  $-12\text{dB}$  and talkback will be heard at normal level. The default setting for J3 is enabled.

### **Control Room Headphone Talkback Dim Enable**

Jumper J4 placed across pins 1 & 2 enables talkback dimming of the control room monitor headphones. With J4 enabled, incoming talkback will dim the headphone source by  $-12\text{dB}$  and talkback will be heard at normal level. The default setting for J4 is disabled (not fitted).

### **Presets**

There are no presets to adjust on the control room monitor channel.

### **Button Mode Settings**

To make the S2 modules as flexible as possible, every button on each channel can be set to a number of different modes. These will aid in the use of the mixer and allow for extra functionality. To make use of these modes, you must enter a setup mode which is exactly the same for every module. It is only necessary to perform this procedure once.

To enter the setup mode, hold down the PGM and AUD buttons together for 5 seconds. After which all the buttons will start a recurring flashing sequence, at this point it is ok to release the PGM and AUD buttons. This sequence indicates the mode which each button is currently set to. One flash equals mode one, two flashes equals mode two etc. To change the mode for a particular button simply press it once and watch the number of flashes increase. Once the maximum mode number has been reached it will simply wrap around to mode one and continue as before. To exit this setup procedure press and hold both the PGM and AUD buttons as before for 2 seconds and the module will start operating as normal.



# 18 S2-OMC CONTROL ROOM MONITOR CHANNEL



## S2-OMC CONTROL ROOM MONITOR CHANNEL

Each button and their corresponding modes are listed below.

### PGM

**Mode 1:** Normal. The program bus can be selected as normal.

**Mode 2:** Always on. The program bus is permanently selected.

**Mode 3:** Always off. The program bus is permanently deselected.

**Mode 4:** Mix. The program bus can be selected as normal but also allows this button to be mixed with other buttons set to mix mode.

### AUD

**Mode 1:** Normal. The audition bus can be selected as normal.

**Mode 2:** Always on. The audition bus is permanently selected.

**Mode 3:** Always off. The audition bus is permanently deselected.

**Mode 4:** Mix. The audition bus can be selected as normal but also allows this button to be mixed with other buttons set to mix mode.

### EXT1

**Mode 1:** Normal. External input 1 can be selected as normal.

**Mode 2:** Always on. External input 1 is permanently selected.

**Mode 3:** Always off. External input 1 is permanently deselected.

**Mode 4:** Mix. External input 1 can be selected as normal but also allows this button to be mixed with other buttons set to mix mode.

### EXT2

**Mode 1:** Normal. External input 2 can be selected as normal.

**Mode 2:** Always on. External input 2 is permanently selected.

**Mode 3:** Always off. External input 2 is permanently deselected.

**Mode 4:** Mix. External input 2 can be selected as normal but also allows this button to be mixed with other buttons set to mix mode.

### Monitor Auto Cue/PFL

**Mode 1:** Normal. Monitor Auto Cue/PFL can be selected as normal.

**Mode 2:** Always on. Monitor Auto Cue/PFL is permanently selected.

**Mode 3:** Always off. Monitor Auto Cue/PFL is permanently deselected.

### Headphone Auto Cue/PFL

**Mode 1 :** Normal. Headphone Auto Cue/PFL can be selected as normal.

**Mode 2 :** Always on. Headphone Auto Cue/PFL is permanently selected.

**Mode 3 :** Always off. Headphone Auto Cue/PFL is permanently deselected.

### Split Cue/PFL

**Mode 1 :** Normal. Split Cue/PFL can be selected as normal.

**Mode 2 :** Always on. Split Cue/PFL is permanently selected.

**Mode 3 :** Always off. Split Cue/PFL is permanently deselected.

**Note: Split Cue/PFL is dependent on Headphone Auto Cue/PFL being selected.**





## 19 S2-OMS Studio Monitor Channel

### Panel Controls

#### PGM, AUD, EXT 1 & EXT 2 Selection

The electronically interlocking PGM, AUD, EXT 1 & EXT 2 buttons select the monitor source for the studio headphones and loudspeaker monitors. The buttons illuminate to show the selected source, PGM and AUD in green, EXT 1 and EXT 2 in red. The External Inputs are used for monitoring an off air signal or another studio output.

#### Monitor Level

The studio monitor loudspeaker level can be variable between 0 (cut off) and 10 (maximum). The output will need to be fed to a suitable power amplifier to drive the loudspeakers.

#### Monitor Auto CUE/PFL

When the green illuminated Auto CUE/PFL button is selected, any input channels selected to CUE/PFL are automatically routed to the studio monitor loudspeakers.

#### Mute

The red mute LED will illuminate whenever a mic channel, which has been designated to studio mute, goes live. This will mute the studio monitors to prevent feedback. Two pairs of contacts on the remote connector of the AUD output channel will close whenever the mute function is active. These can be used to remotely illuminate "Mic Live" lights.

#### Phones

The studio headphone level can be variable between 0 (cut off) and 10 (maximum). Internal amplifiers provide enough drive for headphone impedances of 35 ohms and above.

#### Phones Auto CUE/PFL

When the yellow illuminated AUTO CUE/PFL button is selected, any input channels selected to CUE/PFL are automatically routed to the studio headphones.

#### Studio T/B (Talkback)

When pressed, the STUDIO T/B button will route talkback from the control room talkback microphone channel to the studio loudspeakers and/or the studio headphones, depending on jumper settings. The talkback signal will replace or mix with the monitored source depending on jumper settings.



S2-OMS



## Rear Panel

### External Inputs Connector

This 9 pin D type plug is used for the stereo balanced external input signals.

The connector pin-out is as follows;

- Pin 1: Chassis ground.
- Pin 2: Ext 1 left phase.
- Pin 3: Ext 1 right phase.
- Pin 4: Ext 2 left phase.
- Pin 5: Ext 2 right phase.
- Pin 6: Ext 1 left non-phase.
- Pin 7: Ext 1 right non-phase.
- Pin 8: Ext 2 left non-phase.
- Pin 9: Ext 2 right non-phase.

### Studio Headphones Connector

This standard 6.35mm jack socket is the output for the studio headphones, and has the following connections;

- Tip: Left channel.
- Ring: Right channel.
- Sleeve: Screen.

### Studio Monitor Connector

This standard 6.35mm jack socket is the output for the studio monitor loudspeakers, and has the following connections;

- Tip: Left channel.
- Ring: Right channel.
- Sleeve: Screen.

A suitable amplifier should be used to send this signal to the loudspeakers, or connect active loudspeakers directly to this output.





## Channel Options and Jumper Settings

The studio monitor channel can be configured in a number of different ways depending on the jumper options set on the board. The on-board processor's software is configured by jumpers J1 to J4 and channel identifying links. The control room monitor is identified by having link LK11 fitted.

The standard options available are;

- Enable/disable global talkback.
- Enable/disable talkback to loudspeakers.
- Enable/disable talkback dimming on loudspeakers.
- Enable/disable talkback dimming on headphones.

### Summary of Jumper Settings for the Studio Monitor Channel

Jumper	Set over Pins	Effect
J1	1 & 2 <b>None</b>	Global talkback enabled. Global talkback disabled.
J2	<b>1 &amp; 2</b> None	Studio Loudspeaker talkback enabled. Studio Loudspeaker talkback disabled.
J3	<b>1 &amp; 2</b> None	Studio Loudspeaker talkback dimming enabled. Studio Loudspeaker talkback dimming disabled.
J4	1 & 2 <b>None</b>	Studio Headphones talkback dimming enabled. Studio Headphones talkback dimming disabled.

**Note: Options in bold are set as default when shipped.**

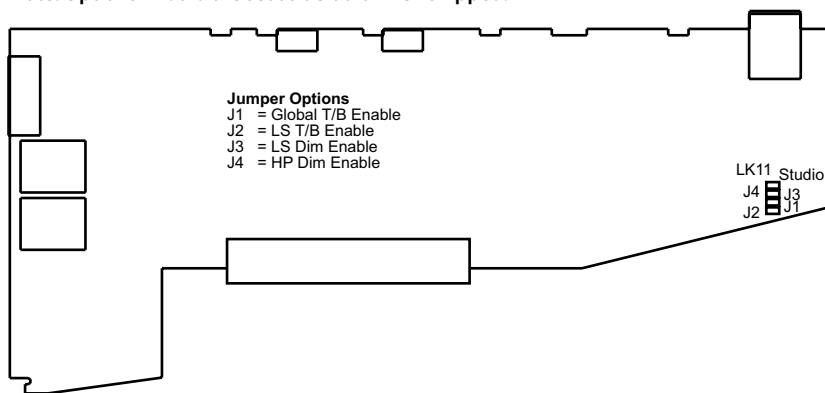

Fig 19-1 : Studio Monitor Board Layout.

### Global Talkback Enable

Jumper J1 placed over pins 1 & 2 enables global talkback. This is a system whereby all programme presenters, guests etc. can talk to each other from their individual microphones via the monitoring system. When enabled, the system becomes active when the control room and studio mutes are inactive i.e. no Mic channels with mic live muting are active. The monitored source on each person's headphones will dim by  $-12\text{dB}$  and they will be able to talk and hear each other at a normal level. When a microphone channel fader is raised, triggering a mute, the system will drop back into normal monitoring. The default setting for J1 is disabled (not fitted).

### Studio Loudspeaker Talkback Enable

Jumper J2 placed over pins 1 & 2 enables talkback to the studio monitor loudspeakers. This will allow talkback, activated by pressing the Studio T/B button, to replace the monitored source on the loudspeaker monitors. If the monitors are already muted then talkback will be muted too. Talkback will also appear on the studio headphones as a replacement to the monitored source. The default setting for J2 is enabled.

### Studio Loudspeaker Talkback Dim Enable

Jumper J3 placed across pins 1 & 2 enables talkback dimming of the studio monitor loudspeakers. With J2 and J3 enabled, incoming talkback will dim the monitored source by  $-12\text{dB}$  and talkback will be heard at normal level. The default setting for J3 is enabled.

### Studio Headphones Talkback Dim Enable

Jumper J4 placed across pins 1 & 2 enables talkback dimming of the studio monitor headphones. With J4 enabled, incoming talkback will dim the headphone source by  $-12\text{dB}$  and talkback will be heard at normal level. The default setting for J4 is disabled (not fitted).

### Presets

There are no presets to tamper with on the studio monitor channel.

### Button Mode Settings

To make the S2 modules as flexible as possible, every button on each channel can be set to a number of different modes. These will aid in the use of the mixer and allow for extra functionality. To make use of these modes, you must enter a setup mode which is exactly the same for every module. It is only necessary to perform this procedure once.

To enter the setup mode, hold down the PGM and AUD buttons together for 5 seconds. After which all the buttons will start a recurring flashing sequence, at this point it is ok to release the PGM and AUD buttons. This sequence indicates the mode which each button is currently set to. One flash equals mode one, two flashes equals mode two etc. To change the mode for a particular button simply press it once and watch the number of flashes increase. Once the maximum mode number has been reached it will simply wrap around to mode





one and continue as before. To exit this setup procedure press and hold both the PGM and AUD buttons as before for 2 seconds and the module will start operating as normal.

Each button and their corresponding modes are listed below.

#### PGM

**Mode 1** : Normal. The program bus can be selected as normal.

**Mode 2** : Always on. The program bus is permanently selected.

**Mode 3** : Always off. The program bus is permanently deselected.

**Mode 4** : Mix. The program bus can be selected as normal but also allows this button to be mixed with other buttons set to mix mode.

#### AUD

**Mode 1** : Normal. The audition bus can be selected as normal.

**Mode 2** : Always on. The audition bus is permanently selected.

**Mode 3** : Always off. The audition bus is permanently deselected.

**Mode 4** : Mix. The audition bus can be selected as normal but also allows this button to be mixed with other buttons set to mix mode.

#### EXT1

**Mode 1** : Normal. External input 1 can be selected as normal.

**Mode 2** : Always on. External input 1 is permanently selected.

**Mode 3** : Always off. External input 1 is permanently deselected.

**Mode 4** : Mix. External input 1 can be selected as normal but also allows this button to be mixed with other buttons set to mix mode.

#### EXT2

**Mode 1** : Normal. External input 2 can be selected as normal.

**Mode 2** : Always on. External input 2 is permanently selected.

**Mode 3** : Always off. External input 2 is permanently deselected.

**Mode 4** : Mix. External input 2 can be selected as normal but also allows this button to be mixed with other buttons set to mix mode.



#### Monitor Auto Cue/PFL

**Mode 1** : Normal. Monitor Auto Cue/PFL can be selected as normal.

**Mode 2** : Always on. Monitor Auto Cue/PFL is permanently selected.

**Mode 3** : Always off. Monitor Auto Cue/PFL is permanently deselected.

#### Headphone Auto Cue/PFL

**Mode 1** : Normal. Headphone Auto Cue/PFL can be selected as normal.

**Mode 2** : Always on. Headphone Auto Cue/PFL is permanently selected.

**Mode 3** : Always off. Headphone Auto Cue/PFL is permanently deselected.



# 20 METERBRIDGE MODULES



## METERBRIDGE MODULES

### 20 Meterbridge Modules

The meterbridge area can house different styles of metering, dual timer, PFL/Talkback speaker, switcher and talkback modules. S2's meterbridge modules are freely assignable so that you can position them exactly where you want them.

#### Meterbridge Module Types

Three styles of dual meter panels, for displaying signal levels, are available for mounting in the meterbridge: Dual VU panel **S2-MVU**, dual PPM panel **S2-MPPM**, and dual true PPM panel **S2-MPPT\***. The **S2-ML53** is an LED meter for displaying both VU and PPM scales. Illuminated LEDs on each meter panel indicate the monitoring source.

A meterbridge panel, **S2-MPH** can be linked to a dual meter panel and used to display phase information on the selected source.

A meterbridge loudspeaker panel, **S2-ML**, can be used to monitor PFL and Reverse Talkback via separate level controls. The speaker will mute in a "mic live" situation.

A comprehensive dual timer display, **S2-MT**, is available for timing events triggered from mic or line input modules. The timer can also display the real time and date synchronised to a standard time broadcast.

Two talkback panels are available. The **S2-MTB6** can be used for communicating with up to 6 other mixers or dedicated talkback systems, and the **S2-MTBS** is used for interfacing with a Sonifex Station Master.

One, or two source select panels, **S2-M6SS**, can be used to expand the number of input sources monitored using the EXT 1 and EXT2 buttons (6 for each), as well as a general input source selector for other applications.

A 1 button switch panel, **S2-MSB1**, and 3 button switch panel, **S2-MSB3**, are 1 channel wide meterbridge panels, with 1 and 3 buttons respectively which can be used for bespoke control of the S2, or for your own purposes, e.g. for equipment control.

\* **Please note** that the S2-MPPT has been discontinued.

S2-MPPM	Meterbridge PPM panel.
S2-MPPT	Meterbridge true PPM meter panel. (This product has been discontinued)
S2-MVU	Meterbridge VU meter panel.
S2-ML53	Meterbridge LED Meter panel.
S2-MPH	Meterbridge Phase Meter panel.
S2-MT	Meterbridge dual timer panel.
S2-ML	Meterbridge loudspeaker monitor and talkback panel.
S2-MTB6	Meterbridge 6 way talkback panel.
S2-MTBS	Meterbridge Station Master talkback panel.
S2-M6SS	S2 Meterbridge 6 way source select panel.
S2-MSB1	Meterbridge 1 button switch panel.
S2-MSB3	Meterbridge 3 button switch panel.
S2-MB1-5	Meterbridge blanking plate channel width 1-5.



### Meterbridge Distribution Board

The Meterbridge Distribution Board is situated in the rear section of the meterbridge metalwork and is the interface between the channel area of the desk and the meterbridge modules. Six connectors on the board provide power and various signals to the meterbridge modules and it is therefore possible, where space permits, to install 1 x **S2-ML**, 1 x **S2-MT**, and up to three of your chosen style of meter panels. Meters can be configured to display PFL, PGM, or Monitor, which is the signal selected by the buttons on the PGM output module. The sixth connector provides power only for customer option meterbridge units.

The meterbridge distribution board has active circuitry allowing a basic mixer set up with one set of meters displaying the PGM output, or PGM output interrupted by PFL. Jumpers J1 and J2 select between: PGM output, jumpers over pins 1 & 2, or PGM interrupted by PFL, jumpers over pins 2 & 3. Meters should be plugged up to the "Output Meter" connector, PL6. The red "PFL" led will illuminate when PFL is being displayed.

When the S2 is used for a split frame installation, a meterbridge distribution board is fitted to each meterbridge section.

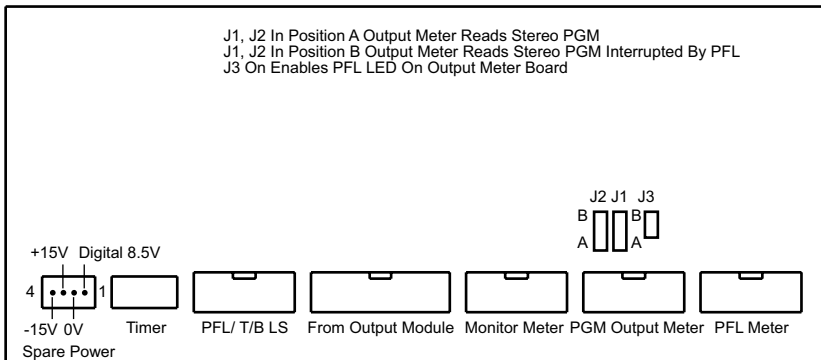

Fig 20-1 : Meterbridge Distribution Board Layout.



## S2-MB1-5 Meterbridge Blanking Plates

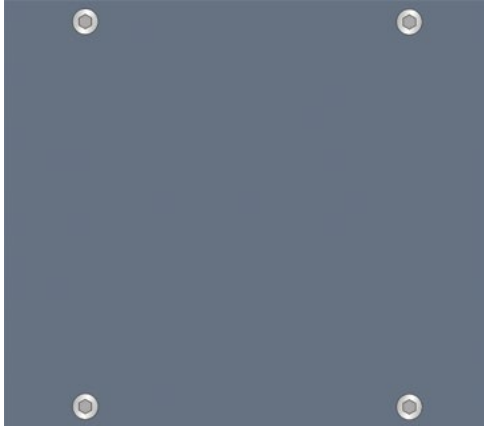

Fig 20-2 : Blanking Plate.

Meterbridge blanking plates are available in channel widths from 1 to 5 inclusive and are used to fill areas in the meterbridge not occupied by active modules.

## S2-ML Meterbridge Loudspeaker Monitor Panel



Fig 20-3 : Loudspeaker Monitor Panel.

The speaker is used for monitoring PFL and reverse talkback in the control room directly from the mixer. Two control knobs are provided for adjusting the levels of the PFL and Talkback signals from cut-off at 0 to unity gain at 10. The speaker is muted automatically when the control room mute is active, to prevent feedback.

**S2-MVU Meterbridge VU Meter Panel, S2-MPPM PPM Meter Panel, S2-MPPT True PPM Meter Panel & S2-ML53 LED Meter Panel\***



METERBRIDGE MODULES



Fig 20-4: PPM & True PPM Meter Panel.



Fig 20-5: VU Meter Panel.

\* **Please note** that the S2-MPPT has been discontinued.

# 20 METERBRIDGE MODULES



## METERBRIDGE MODULES

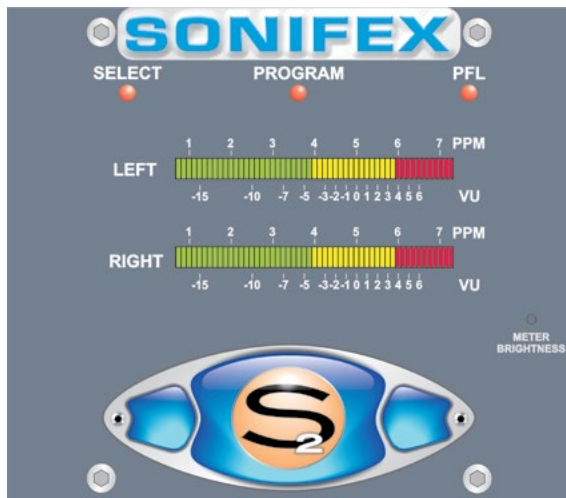

Fig 20-6 : VU & PPM LED Meter Panel.

The dual meter panels are used for monitoring console signal levels.

The S2-MPPM panel has two fast-reading moving-coil meters with PPM-style scale.

The S2-MPPT\* panel has two moving-coil PPM movements, conforming to true PPM ballistics.

The S2-ML53 panel has an LED meter display with both PPM and VU scales.

The PPMs have a 1-7 scale and will be configured such that a 1kHz signal, at 0dBu at the PGM output, will indicate a meter reading of 4. Each mark on the PPM scale indicates a 4dB change in signal level.

The S2-MVU two moving coil VU meters will be configured such that a 1kHz signal, at +4dBu at the PGM output, will indicate a meter reading of 0VU.

The LED meter panel displays both VU and PPM readings simultaneously.

The meters can be configured internally to be fed from one of three signal sources,

\* **Please note** that the S2-MPPT has been discontinued.

Program	PGM output which can optionally be interrupted by PFL. Plug into the OUTPUT METER connector on the meterbridge distribution board, and set jumpers J1-J3.
Select	The output of the meter switch on the AUD output module which can show PGM, AUD, or CR MON, which is the selected monitor source on the control room monitor module, (EXT 1, EXT 2, PGM, or AUD) interrupted by PFL. Plug into the MONITOR METER connector on the meterbridge distribution board.
PFL	The output of the PFL bus. Plug into the PFL METER connector on the meterbridge distribution board.



It is therefore possible, depending on the frame size, to house up to three meter panels, thereby providing a comprehensive metering system. Illuminated LEDs indicate the relevant source shown on the meters.

The S2-ML53 has an adjustable pot accessible from the front panel which alters the meter brightness, this can be altered using a jewellers screwdriver.

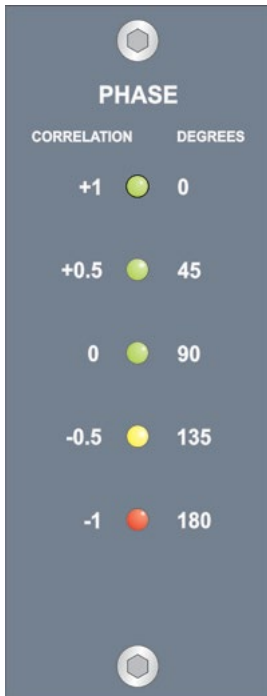

### S2-MPH Meterbridge Phase Meter Panel

The S2-MPH is a phase meter which operates on the selected source to the meters. 5 LED indicators show the phase angle in 45 degree steps from 0 (in-phase) to 180 (out of phase). A separate phase meter can be linked to each meter in the meterbridge by use of the supplied in-line cable.

Fig 20-7 : Phase Meter Panel.



## S2-MTB6 Meterbridge 6 Way Talkback Panel

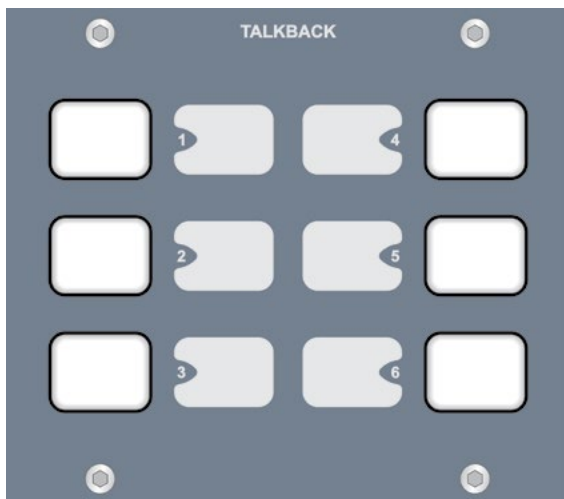

Fig 20-8 : Meterbridge 6 Way Talkback Panel.

The S2-MTB6 Meterbridge Talkback Panel is used for communicating with up to 6 other locations. While a button is pressed, the switch is illuminated and the talkback is active. The buttons work with both a momentary and latched operation. If held down, the selection is cancelled when released, otherwise the button is alternate action.

### Rear Panel

#### External Talkback Connector

This 15 pin D type plug is used for connecting to other talkback panels in other mixers, or dedicated talkback systems.

The connector pin-out is as follows;

Pin 1: Talkback 1 out phase.

Pin 2: Talkback 2 out phase.

Pin 3: Talkback 3 out phase.

Pin 4: Talkback 4 out phase.

Pin 5: Talkback 5 out phase.

Pin 6: Talkback 6 out phase.

Pin 7: Talkback in phase.

Pin 8: Ground.

Pin 9: Talkback 1 out non-phase.

Pin 10: Talkback 2 out non-phase.

Pin 11: Talkback 3 out non-phase.

Pin 12: Talkback 4 out non-phase.

Pin 13: Talkback 5 out non-phase.

Pin 14: Talkback 6 out non-phase.

Pin 15: Talkback in non-phase.



### Mixer Talkback Connector

This 9 pin D type plug is used for connecting the Talkback module to the Control Room Monitor channel. The connection cable is supplied with the Talkback module, which plugs into the S2-MTB6 via the mixer meterbridge housing, and down into the two talkback jack sockets on the rear of the Control Room channel.

The connector pin-out is as follows;

- Pin 1: Talkback in phase (to mixer).
- Pin 2: Talkback control.
- Pin 3: No connection.
- Pin 4: Talkback out phase (from mixer).
- Pin 5: Ground.
- Pin 6: Talkback in non-phase (to mixer).
- Pin 7: No connection.
- Pin 8: Talkback out non-phase (from mixer).
- Pin 9: No connection.



### S2-MTBS Meterbridge Station Master Talkback Panel

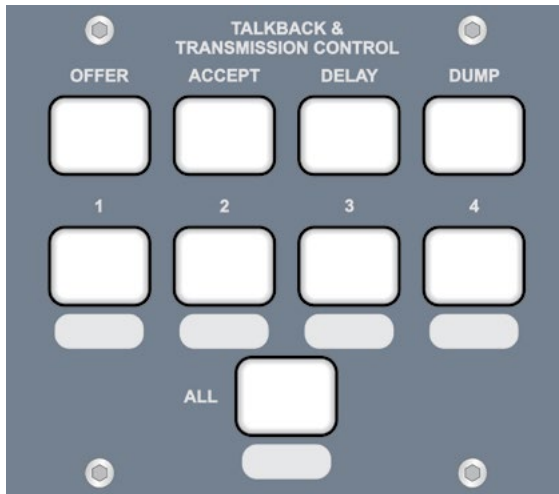

Fig 20-9 : Meterbridge Station Master Talkback Panel.

The S2-MTBS panel is used for interfacing with a Sonifex Station Master. See the Station Master manual for functionality and connection information.

### Rear Panel

#### Station Master Talkback Connector

This 25 pin D type socket is used for connecting to the Talkback connector on a Sonifex Station Master.

# 20 METERBRIDGE MODULES



## METERBRIDGE MODULES

The connector pin-out is as follows;

- Pin 1: +15V.
- Pin 2: Offer switch.
- Pin 3: Accept switch.
- Pin 4: Delay switch.
- Pin 5: Dump switch.
- Pin 6: Talkback 1 switch.
- Pin 7: Talkback 2 switch.
- Pin 8: Talkback 3 switch.
- Pin 9: Talkback 4 switch.
- Pin 10: Talkback all switch.
- Pin 11: Ground.
- Pin 12: Talkback out.
- Pin 13: Talkback control out.
- Pin 14: Ground.
- Pin 15: Offer indicator.
- Pin 16: Accept indicator.
- Pin 17: Delay indicator.
- Pin 18: Dump indicator.
- Pin 19: Talkback 1 indicator.
- Pin 20: Talkback 2 indicator.
- Pin 21: Talkback 3 indicator.
- Pin 22: Talkback 4 indicator.
- Pin 23: Talkback in.
- Pin 24: Ground.
- Pin 25: Ground.

### **Mixer Talkback Connector**

This 9 pin D type plug is used for connecting the Talkback module to the Control Room Monitor channel. The connection cable is supplied with the Talkback module, which plugs into the S2-MTBS via the mixer meterbridge housing, and down into the two talkback jack sockets on the rear of the Control Room channel.

The connector pin-out is as follows;

- Pin 1: Talkback in phase (to mixer).
- Pin 2: Talkback control.
- Pin 3: No connection.
- Pin 4: Talkback out phase (from mixer).
- Pin 5: Ground.
- Pin 6: Talkback in non-phase (to mixer).
- Pin 7: No connection.
- Pin 8: Talkback out non-phase (from mixer).
- Pin 9: No connection.

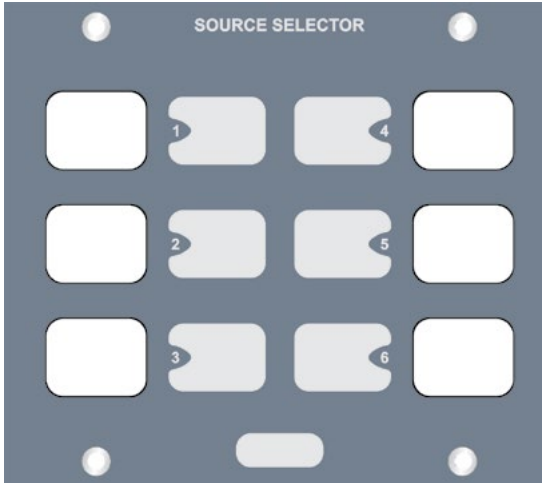

Fig 20-10a : S2-M6SS Panel.

### S2-M6SS Meterbridge 6 Way Source Select Panel

The meterbridge source selector panel produces a stereo analogue audio output from 6 selectable stereo analogue sources, which can be connected to a stereo input channel within the mixer or the EXT 1 and EXT 2 monitor inputs to provide up to 12 external monitor inputs. There are 6 illuminated panel push buttons, which select and indicate the current channel selection. The 6 stereo sources are connected on the rear of the panel via a 25 way D-Type female (socket) connector, which uses exactly the same pin configuration as the stereo audio source input connector on the S2-C6SS channel. The single stereo output is provided on a 9 way D-type male (plug) and the pin configurations are shown below.

#### Audio Input Connector - 25 pin D-type female (socket)

- Pin 1: Ground.
- Pin 2: Input 1 left phase.
- Pin 3: Input 1 right phase.
- Pin 4: Input 2 left phase.
- Pin 5: Input 2 right phase.
- Pin 6: Input 3 left phase.
- Pin 7: Input 3 right phase.
- Pin 8: Input 4 left phase.
- Pin 9: Input 4 right phase.
- Pin 10: Input 5 left phase.
- Pin 11: Input 5 right phase.
- Pin 12: Input 6 left phase.
- Pin 13: Input 6 right phase.
- Pin 14: Input 1 left non-phase.
- Pin 15: Input 1 right non-phase.
- Pin 16: Input 2 left non-phase.





- Pin 17: Input 2 right non-phase.
- Pin 18: Input 3 left non-phase.
- Pin 19: Input 3 right non-phase.
- Pin 20: Input 4 left non-phase.
- Pin 21: Input 4 right non-phase.
- Pin 22: Input 5 left non-phase.
- Pin 23: Input 5 right non-phase.
- Pin 24: Input 6 left non-phase.
- Pin 25: Input 6 right non-phase.

**Audio Output Connector (To Mixer) - 9 pin D-type male (plug)**

- Pin 1: Screen.
- Pin 2: Out left phase.
- Pin 3: Out right phase.
- Pin 4: No connection.
- Pin 5: No connection.
- Pin 6: Out left non-phase.
- Pin 7: Out right non-phase.
- Pin 8: No connection.
- Pin 9: No connection.

**Power Connectors**

- Pin 1: +VD.
- Pin 2: Ground.
- Pin 3: +15V.
- Pin 4: -15V.

There are two power connectors on the board, a 'power input' and a 'power through' connector. The power input connector should be connected to the meterbridge distribution board power connector, or the 'power through' connector on another meterbridge panel. The 'power through' connector can be used to daisy chain power down the meterbridge housing, for example, to an S2-MT panel.

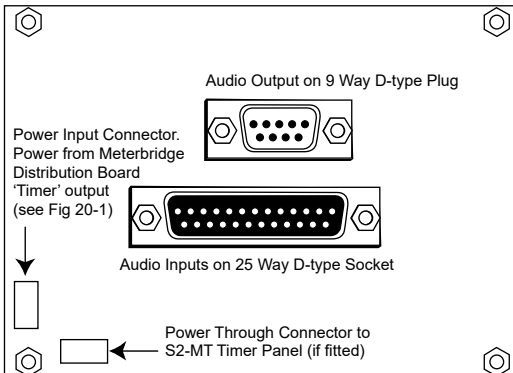

Fig 20-10b : S2-M6SS Diagram.

## S2-MSB1 Meterbridge Switch Panel With 1 Button

This is a meterbridge panel, 1 channel wide, with 1 button which can be used for bespoke control of the S2, or for your own purposes, e.g. equipment control. Contact Sonifex with your particular mixer control requirements.

To make the switch illuminate either green, red or orange, set the jumper(s) next to the button to either GRN, RED or GRN & RED (for orange).

## S2-MSB3 Meterbridge Switch Panel With 3 Buttons

This is a meterbridge panel, 1 channel wide, with 3 push button switches which can be used for bespoke control of the S2 or ancillary devices.

To make the switches illuminate either green, red or orange, set the jumper(s) next to the button to either GRN, RED or GRN & RED (for orange).

The connector used for both the S2-MSB1 and S2-MSB3 is a 9 pin D-type female and the pin-out details are as follows:

	<b>S2-MSB1</b>	<b>S2-MSB3</b>
<b>Female D-Type</b>	<b>Switch Panel Connection</b>	<b>Switch Panel Connection</b>
Pin 1	N/C	Switch 1*
Pin 2	Switch 2	Switch 2*
Pin 3	N/C	Switch 3*
Pin 4	N/C	Switch 1 LED**
Pin 5	Switch 2 LED**	Switch 2 LED**
Pin 6	N/C	Switch 3 LED**
Pin 7	0V	0V
Pin 8	0V	0V
Pin 9	+12V LED Power Input	+12V LED Power Input

\* Switch Output (connected to 0V on activation)

\*\* Pull to 0V to activate

To power the switch button LEDs, a 12V power supply of at least 100mA must be used. +15V, which can be used, is available from the spare power connector on the meterbridge distribution board, (see Fig 20-1 on page 133).

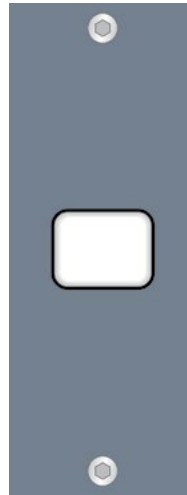

Fig 20-11a : S2-MSB1 S2 Meterbridge Switch Panel With 1 Button.

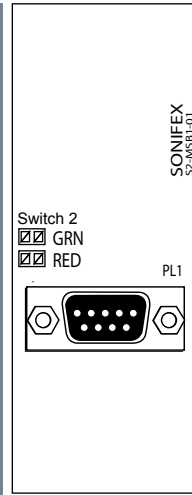

Fig 20-11b : S2-MSB1 Diagram.



Fig 20-12a : S2-MSB3 S2 Meterbridge Switch Panel With 3 Buttons.

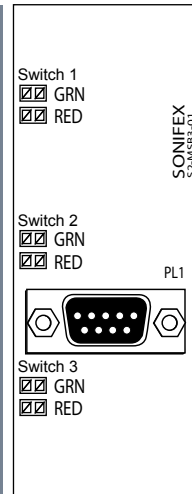

Fig 20-12b : S2-MSB3 Diagram.





## S2-MT Meterbridge Timer Panel

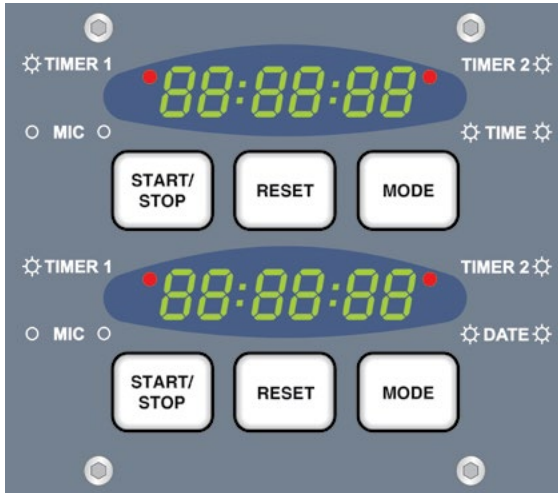

Fig 20-13 : Meterbridge Timer Panel.

### Overview

Each of the dual timers can be used for timing events triggered by Timer 1, Timer 2, or the Mic fader open signal. In addition the upper timer is used for displaying the time of day and the lower timer for displaying the date. The illumination pattern of the red LEDs indicates the timer display mode.

The date and time can be synchronised to a very accurate internal clock or optionally from an external source, MSF, DCF, SMPTE, or RS232 time code string.

### Panel Controls

#### START / STOP

When the display is in Timer 1, Timer 2 or MIC timer (manual) mode, this button causes the timer to start, if currently stopped, or stop, if currently running. This button has other functions when the display is in other modes, which are described below.

#### RESET

When the display is in Timer 1, Timer 2 or MIC timer (manual) mode, this button causes the timer to be reset, but only if that timer is not currently running.

#### MODE

Changes the current display mode from TIMER 1, to TIMER 2, to MIC, to TIME (or DATE) back to TIMER 1 again. This button also has other functions, which are described below.

#### Quick Date View

Hold down the upper timer "START/STOP" button while in Time mode. The Date will be displayed until the button is released.

## Quick Time View

Hold down the lower timer “START/STOP” button while in Date mode.  
The Time will be displayed until the button is released.

## Rear Panel

### RS232 Connector

This 9 pin D type plug is used for connecting to another RS232 enabled device (e.g PC’s Com port).

The connector pin-out is as follows;

- Pin 1: CD.
- Pin 2: Receive Data (From PC).
- Pin 3: Transmit Data (To PC).
- Pin 4: DTR.
- Pin 5: Ground.
- Pin 6: DSR.
- Pin 7: RTS.
- Pin 8: CTS.
- Pin 9: No internal connection.

**NOTE: Only Pins 2 & 3 are currently used.**

### MSF/DCF Antenna & SMPTE/EBU Connector

This 9 pin D type socket is used for receiving a time code signal from an MSF/DCF antenna or other compatible sources.

The connector pin-out is as follows;

- Pin 1: Signal+.
- Pin 2: Signal-.
- Pin 3: Ground.
- Pin 4: +VD.
- Pin 5: No internal connection.
- Pin 6: Ground.
- Pin 7: Ground.
- Pin 8: 5V.
- Pin 9: 5V.

+VD: Digital power rail. ~8.5V.

## Configuring The Timer

The timers are configured according to the following comprehensive instructions,

### Setting The Time

- Hold down the upper timer Mode button for 5 seconds.
- The upper display will now be displaying the date with the year digits flashing.





- Use the Start/Stop & Reset buttons to increment/decrement the year.
- Then press the Mode button to select the Month, then the Day, Hour, Minutes, Seconds.
- When the seconds have been set, the next press of the Mode button stores the time, and exit the time setting mode.

### Setting The Mode

- Hold down the lower timer Mode button for 5 seconds.
- To increment Option numbers press the same mode button.
- To increment/decrement sub option number use the Start/Stop & Reset buttons.
- Continue to the last option (14), the next mode press will store the settings.

Option Number	Sub Option Number	Description
0	-	Time Code Synchronisation Source
	0	None
	1	MSF Radio Time Code
	2	DCF Radio Time Code
	3	SMPTE/EBU Time Code (see option 15)
	4	RS232 Time Code String

### Time Code Synchronisation Source

There are numerous types of Radio Time Code that could be added to this list, but at present only those listed are supported. Other time code options can be implemented depending on availability of test sources and/or customer demand. The Time Codes commonly supported are selectable via option 0.

### Indication of Lock to Source

Hold down the upper timer "RESET" button while in TIME mode, a status indication will be displayed. This code is identical to that of the time code output string:

0 = not locked, 1 = signal/not locked, 2 = locked

Also note that source number 0 (internal RTC) implies "not locked".



## RS232 Port

The RS232 communications port is fully configurable, with separate options for data bits, stop bits, and baud rate, which can all be set independently of each other.

Option Number	Sub Option Number	Description
1	-	RS232 Data Bits
	0	7 data bits
	1	8 data bits
2	-	RS232 Stop Bits
	0	1 stop bit
	1	2 stop bits
3	-	RS232 Parity
	0	None
	1	Even parity
	2	Odd parity
4	-	RS232 Baud Rate
	0	9600 baud
	1	19200 baud
	2	38400 baud
	3	57600 baud
5	-	RS232 Output
	0	Disable
	1	Enable



## RS232 Output Format

A time code string can be output from the timer module for use in synchronising other devices to the module.

```
"dd/mm/yy, hh:mm:ss,A,B,C,D, hh:mm:ss.tt, hh:mm:ss.tt, hh:mm:ss.tt\r\n"  
DATE, TIME, [3 MODE CH], TIMER_1, TIMER_2, MIC_TIMER.
```

A = Date string format. (See option no. 6)

B = Time code synchronisation source (see option no. 0)

C = Indication of lock to source 0 = not locked, 1 = signal/not locked, 2 = locked.

Also note that source number 0 (internal RTC) implies "not locked".

D = Indication of presence of timecode signal 0 = No signal, 1 = Signal present.

\n = New Line.

\r = Carriage return.

## RS232 Input Format

```
"dd/mm/yy, hh:mm:ss\r\n"  
DATE, TIME
```

(Date format is dependent on setting of option no. 6.)



Option Number	Sub Option Number	Description
6	-	Date Display Format
	0	dd/mm/yy
	1	dd/yy/mm
	2	mm/dd/yy
	3	mm/yy/dd
	4	yy/dd/mm
	5	yy/mm/dd

### Timers and Timer Events

The timers and their event handling can be configured using the options below. If the timer is not currently being displayed the module can automatically switch to this timer when an event occurs. If the timer is currently running the event can trigger the timer to reset or continue counting. On an event the display will freeze for a determined number of seconds.

Option Number	Sub Option Number	Description
7	-	Timer1
	0	On event do not display (unless already displayed)
	1	On event show to display 1
	2	On event show to display 2
8	-	Timer 1 Event Option
	0	On event restart timer
	1	On event split timer
9	-	Timer 2
	0	On event do not display (unless already displayed)
	1	On event show to display 1
	2	On event show to display 2
10	-	Timer 2 Event Option
	0	On event restart timer
	1	On event split timer
11	-	Mic Timer
	0	On event do not display (unless already displayed)
	1	On event show to display 1
	2	On event show to display 2
12	-	Mic Timer Control
	0	Auto mode: The Mic timer is controlled via the Mic fader only.
	1	Manual mode: The Mic timer can be controlled via the module control buttons and/or the Mic Fader.



Option Number	Sub Option Number	Description
13	-	Freeze Time
	0	On second event freeze display for 1 second
	1	On second event freeze display for 2 seconds
	2	On second event freeze display for 3 seconds
	3	On second event freeze display for 4 seconds
	4	On second event freeze display for 5 seconds
14	-	Time Setting
	0	Disallow while locked to time code source
	1	Allow while locked to time code source
15	-	SMPTE/EBU Timecode settings
	0	Ignore date
	1	Date Format 1
	2	Date Format 2
	3	Date Format 3

**SMPTE/EBU Timecode Settings**

Setting sub option 0 in option 15 will allow the unit to ignore any date information within the timecode stream. The date will be displayed as “---:---:---”.

The remaining sub options allow the unit to handle various date formats within the timecode. The formats are defined as follows:

Date Format 1			Date Format 2			Date Format 3		
Bits	12 to 15	Days Units	Bits	20 to 23	Years Units	Bits	20 to 23	Years Units
Bits	20 to 23	Months Units	Bits	28 to 31	Years Tens	Bits	28 to 31	Years Tens
Bits	28 to 29	Days Tens	Bits	36 to 39	Months Units	Bits	36 to 39	Days Units
Bits	30	Month Tens	Bits	44 to 45	Month Tens	Bits	44 to 45	Days Tens
Bits	44 to 47	Years Units	Bits	52 to 55	Days Units	Bits	52 to 55	Months Units
Bits	60 to 63	Years Tens	Bits	60 to 62	Days Tens	Bits	60 to 62	Month Tens



## 21 Technical Specifications

### Input/Output Impedances

Mic Input:	> 1k5Ω electronically balanced.
Mono Line Input:	> 20kΩ electronically balanced.
Stereo Line Input:	> 20kΩ electronically balanced.
PGM & AUD Output:	< 75Ω electronically balanced.
Mono Output:	< 75Ω electronically balanced.
Monitor Outputs:	< 75Ω unbalanced.
AES Input/Output:	110Ω
S/PDIF Input/Output:	75Ω
BNC Wordclock input:	50Ω

### Input/Output Gain Range

Mic Input:	Preset pot +13dB to +66dB ref -50dBu, TRIM pot ± 12dB
Mono Line Input:	Preset pot -6dB to +10dB ref 0dBu, TRIM pot ± 12dB
Stereo Line Input:	Preset pot -6dB to +10dB ref 0dBu, TRIM pot ± 12dB
Telco Input:	Preset pot -6dB to +10dB ref 0dBu, TRIM pot ± 12dB
Telco Output:	Preset pot -6dB to +4dB ref 0dBu
Mix Minus Input:	Preset pot -6dB to +10dB ref 0dBu, TRIM pot ± 12dB
Mix Minus Output:	Preset pot -3dB to +3dB ref 0dBu
Digital Input:	0dBFS = +12dBu on input; TRIM pot ± 12dB allowing 0dBu to +24dBu
Digital Output:	0dBFS = +18dBu

### Frequency Response

Mic Input:	40Hz to 20kHz -1dB, +0dB (-3dB at 130Hz with HPF in).
Line Inputs:	20Hz to 20kHz -0.5dB, +0dB.
RIAA Input:	30Hz to 16kHz ± 1.5dB RIAA equalised.

### Noise (20Hz to 20kHz)

Mic Input E.I.N.:	-129dB with 150Ω source.
Stereo Inputs (fader down, no routing):	-89dB ref 0dB

Stereo Inputs (fader down, one channel routed): -89dB

Stereo Inputs (unity gain, no routing): -89dB

Stereo Inputs (unity gain, one channel routed): -86dB

Stereo Inputs (unity gain, two channels routed): -83dB

### Distortion

Total Harmonic Distortion: 0.015% at 1kHz, 0dB.  
0.025% at 10kHz, 0dB.

### Crosstalk

Inter-channel: < -90dBu.

Stereo: -90dBu at 1kHz.

### Equalisation

LF: Shelving at 100Hz. ± 7dB

HF: shelving at 6.5kHz. ± 7dB

### Range

Pan Range off/-3dB centre/off

Balance Range ± 6dB

### Common Mode Rejection Ratio

Mic Input: > 100dB at 70dB gain.

### Digital I/O

Sync Input Sample Rate Range: 30kHz – 100kHz

Output Sample Rates (Using Onboard Clock): 32kHz, 44.1kHz, 48kHz, & 96kHz

Output Sample Width: 16, 20, 24 bit (24 bit on V2 ODA/ODP)

### Output

Headphone Output Load >45 ohms, recommended 400Ω

Maximum Output (Analogue) +26dBu balanced into 2k or greater





### Power

Power Rating (S2-PSU): Filtered IEC, switchable 115V, 230V, fused, 210W max.

Dimensions (S2-PSU):  
 (Raw): 48cm (W) x 24.3cm (D) x 8.8cm (H)  
 19" (W) x 10" (D) x 3.5" (H)  
 (Boxed): 51cm (W) x 41.5cm (D) x 17cm (H)  
 20" (W) x 16.3" (D) x 6.7" (H)

Weight (S2-PSU): Nett: 6kg Gross: 7.8kg  
 Nett: 13.2lbs Gross: 17lbs

Dimensions (S2-PSUS):  
 (Raw): 48cm (W) x 23cm (D) x 4.4cm (H)  
 19" (W) x 9" (D) x 1.7" (H)  
 (Boxed): 55cm (W) x 39.3cm (D) x 8.5cm (H)  
 21.6" (W) x 15.5" (D) x 3.4" (H)

Weight (S2-PSUS): Nett: 1.58kg Gross: 2kg  
 Nett: 3.5lbs Gross: 4.4lbs

### S2 Mixer Weights and Boxed Dimensions

Mixer Chassis Type	Width (cm)	Depth (cm)	Height (cm)	Gross Weight (kg)	Nett Weight (kg)
S2-30	137	70	45	36	34
S2-25	100	70	45	33	31
S2-20	100	70	45	30	28
S2-15	100	70	45	27	25.5
S2-10	80	70	45	24	22.5
S2-05	60	70	45	21	19.5

Note : Weights are approximate and based on a mixer chassis fully loaded with channels.

**Glossary**

<b>Attenuation</b>	The reduction of a signal level. Attenuation is usually measured in dB.
<b>AES</b>	Audio Engineering Society.
<b>AES/EBU</b>	Professional digital audio standard covering frame format, connections and interfaces. Interface is usually on XLR sockets and plugs.
<b>Balance</b>	The relative levels of the left and right channels of a stereo signal.
<b>Cleanfeed</b>	A cleanfeed is the signal produced by the telco module, which is used as the output to be fed back to a caller on a telephone line. A true cleanfeed is the sum of all the other signals, which constitute the programme output, except for the caller's audio.
<b>Clipping</b>	The onset of severe distortion in the signal path, usually caused by the peak signal voltage being limited by the circuit's headroom.
<b>CMRR</b>	Common Mode Rejection Ratio. This is the ratio of the extent to which a differential amplifier will cancel noise, which is present on both inputs, compared to its ability to amplify the wanted signal.
<b>Cross-talk</b>	This is the amount of an unwanted signal which appears, or is induced, on a different or unassimilated signal. The problem is usually most prevalent with adjacent channels.
<b>CUE</b>	See PFL.
<b>dB (decibel)</b>	A ratio of two voltages or signal levels, expressed by the equation $dB=20\text{LOG}(V1/V2)$ <p>Adding the suffix "u" denotes that the signal is relative to 0.775V RMS.          Adding the suffix "v" denotes that the signal is relative to 1V RMS.</p>
<b>De-emphasis</b>	Pre-emphasis and de-emphasis are techniques used to improve the overall signal to noise ratio in communication channels. The frequency response of the channel is weighted with a 6 dB per octave slope prior to transmission (pre-emphasis), and then the inverse of this weighting is applied at the receiving end (de-emphasis) to restore a flat frequency response.
<b>EIN</b>	Equivalent Input Noise. It is the ratio of output noise to the gain. It describes the level of noise which would need to be fed into an ideal amplifier to produce the measured output noise.
<b>EQ</b>	EQualisation. This is the method of cutting or boosting selected bands of frequencies in the signal.





<b>Gain</b>	The degree of amplification, or attenuation applied to a signal.
<b>Hybrid</b>	A device that allows a telephone line to be connected to a broadcast desk in such a way that the caller may hear the programme output without the caller's voice being re-introduced onto the phone line. Essentially a two to four wire converter.
<b>LED</b>	Light Emitting Diode.
<b>Mix-minus</b>	Another method of producing a cleanfeed, except that the caller's voice is removed from the signal electronically. Due to phasing problems at the signal band edges, the mix-minus method often produces a lower grade signal to the true cleanfeed method.
<b>PAN</b>	This controls the levels (usually of a mono signal) sent to the left and right outputs and is an abbreviation of "panorama".
<b>PFL (CUE)</b>	Pre Fade Listen, also called CUE. A function that allows the operator to monitor the pre fader signal independently of the programme output.
<b>Pre-emphasis</b>	see De-emphasis.
<b>S/PDIF</b>	Sony/Phillips Digital Interface. Domestic digital audio interface standard using phono connectors or optically using fibre-optic connectors.
<b>TBU</b>	See hybrid.
<b>T/B</b>	Talkback (and reverse talkback, Rev T/B). This is the ability for two or more studios to communicate with each other off-air.
<b>Telco</b>	TELEphone COmmunication. The telco module is used by the presenter to talk to telephone callers via a hybrid or TBU.
<b>THD</b>	Total Harmonic Distortion.





## Index

### C

Channel Configuration	5
Configuring The Timer	147
Connecting A Split Desk	14
Connectors and Cabling	5
Cough Switch and Talkback On Mic Modules	12

### G

Glossary	155
----------	-----

### I

Input Channels	25
Installation Notes	4
Introduction	1

### M

Meterbridge Distribution Board	135
Meterbridge Modules	134

### O

Output Channels	92
-----------------	----

### P

Power Supply	16
--------------	----

### R

Removing & Replacing Channels	13
Reporting Faults	vi

### S

S2-C6SS 6 Way Stereo Line Source Select Channel With EQ	70
S2 -CDSE/S2-CDS Digital Dual Stereo Line Channel With & Without EQ	61
S2-CML Mic/Line Channel With EQ	28
S2-CMM Mic/Mic Channel With EQ	36
S2-CSE/S2-CS Dual Stereo Line Channel With & Without EQ	43
S2-CSGE/S2-CSG Stereo Line And Gram Channel With & Without EQ	52
S2 CSMM Stereo Mix Minus Channel With EQ	83
S2-CT Telco Channel With EQ	76
S2 Mixer Weights and Boxed Dimensions	154
S2-MT Meterbridge Timer Panel	146
S2-ODAF/S2-ODA Digital Output AUD Channel With & Without Master Fader (Version 1)	108

S2-ODAF/S2-ODA Digital Output AUD Channel With & Without Master Fader (Version 2)	115
S2-ODPF/S2-ODP Digital Output PGM Channel With & Without Master Fader (Version 1)	94
S2-ODPF/S2-ODP Digital Output PGM Channel With & Without Master Fader (Version 2)	101
S2-OMC Control Room Monitor Channel	122
S2-OMS Studio Monitor Channel	128
Safety of Mains Operated Equipment	iv, 17

### T

Technical Specifications	152
--------------------------	-----

### W

Warranty and Liability	i
WEEE & RoHS Directives - Sonifex Statement	v



INDEX

NOTES



NOTES



**NOTES**

# SONIFEX

[www.sonifex.co.uk](http://www.sonifex.co.uk)

t:+44 (0)1933 650 700

f:+44 (0)1933 650 726

[sales@sonifex.co.uk](mailto:sales@sonifex.co.uk)

