

Audio. Control. Power.

**20+20-way Vertical Power Unit
VPB-20+20C13-32A**

Manual

TSL Products Limited.

Units 1&2, Globe Park, Marlow, SL7 1YA

Telephone +44 (0) 1628 564610

CONTENTS		Page No
1.0	Safety & Installation	4
	TSL Returns Procedure	6
2.0	Description	7
3.0	Operation	8
4.0	Pin Outs	8
5.0	Mounting Instructions	9
6.0	Specification	16

SAFETY

1.0 Installation.

Unless otherwise stated TSL equipment may be installed at any angle or position within an operating temperature range of 5 – 45 degrees C.

This equipment is intended for use by suitably qualified personnel only.

All TSL equipment conforms to the EC Low Voltage Directive:

EC Low Voltage Directive (73/23/EEC)(OJ L76 26.3.73)(LVD).
Amendment: (93/68/EEC) (OJ L220 30.8.93).

CAUTION:

Always disconnect equipment connected to a powered VPB before performing any maintenance.

Earthing/Grounding

In all cases, the frame of the equipment must be earthed on installation. Connection to an earthed strip running the length of the frame is ideal.

The earth pin on the mains inlet connector is connected to the metal frame of the equipment unless otherwise stated. All metal panels are bonded together. Rack mounted equipment must be earthed (grounded).

Mounting

Careful consideration of the equipment location and mounting in racks must be made, see section 5 for mounting details.

Power

2 x Neutrik 32A Power/Con connectors type NAC3FC-HC must be used, not supplied with the unit.

<https://www.neutrik.com/en/product/nac3fc-hc>

There is no internal fuse, ensure that each supply is fed from a 32A fused/breaker with a switched removable output. Ensure all wiring conforms to local electrical installation regulations.

Consideration must be given to the supply circuit loading and switch on/fault surges that will affect overcurrent protection trips and switches etc.

For individual high loads ensure that outputs are distributed evenly across the VPB.

Do not exceed the individual rating of 10A for each outlet.

Do not switch on until all connections are made as the powercon connectors are not rated to break under load.

Ventilation

Due consideration for cooling requirements must be given.

General

If equipment is installed in a closed unit, consideration must be given to providing forced air cooling in order that the maximum recommended temperature is not exceeded.

Warranty, Maintenance & Repair

All TSL equipment is guaranteed for one year from the date of delivery to the customer's premises. If the equipment is to be stored for a significant period, please contact TSL concerning a possible extended warranty period.

Failure during warranty

If any TSL product should fail or become faulty within the warranty period, first please check the VPB fuses. All maintenance work must be carried out by trained and competent personnel.

If equipment has to be returned to TSL for repair or re-alignment, please observe the following:

Technical support information

E-Mail address: support@tslproducts.com

Telephone Support Number for the UK and Europe: +44 (0)1628 564610

TSL Returns Procedure

Please telephone +44 (0)1628 564610 and ask for Support who will provide a Returns Number. This will enable us to track the unit effectively and will provide some information prior to the unit arriving.

For each item, this unique Returns Number must be included with the Fault Report sent with the unit.

A contact name and telephone number are also required with the Fault Report sent with the unit.

Fault report details required:

- Company:
- Name:
- Address:
- Contact Name:
- Telephone No:
- Returns Number:
- Symptoms of the fault (to include switch setting positions, input signals etc).

Packing

Please ensure that the unit is well packed as all mechanical damage is chargeable. TSL recommends that you insure your equipment for transit damage.

The original packaging, when available, should always be used when returning equipment.

If returned equipment is received in a damaged condition, the damage should be reported both to TSL and the carrier immediately.

2.0 Description

Features:

- Width = 55mm, Depth = 65mm, Height = 1762mm
- Dual 32A inlet, no changeover, feeding alternate sockets
- 40 IEC front mounted fused outlets supporting C13 3 pin connectors
- LED Indication
 - Power - Blue – Power 1 applied to the unit.
 - Power - Orange - Power 2 applied to the unit.
 - Output LEDs 1 - 40
 - On – Circuit on and fuse working
 - Off – Circuit fuse has failed

Easy mounting from rear or sides for extra flexibility and ease of installation.

Each of the two inlets is via a Neutrik NAC3MP-HC 32A 250VAC connector.

The 40 front mounted IEC outlets are via 10A fuses located on the front panel.

3.0 Operation

This equipment is intended for use by suitably qualified personnel only.

The blue led lights when Neutrik connector A is connected, showing that there is power to the 20 outlets on that circuit. The orange led lights when Neutrik connector B is connected, showing that there is power to the 20 outlets on that circuit.

Each outlet is individually fused and the led indicates that the fuse for that outlet is good. The outlet led light goes off if the outlet's fuse fails.

4.0 Pin-outs

Input

Neutrik PowerCON connector NAC3FC-HC (not supplied by TSL Products)
- L – Brown (Phase), N – Blue (Neutral), E – Green/Yellow (Earth or Ground).

Rack Mounting Guide

5.0 Mounting Instructions

VPB comes prepacked with three mounting brackets and six screws inside the box.



These brackets could be attached to any one of the three mountable side panels, left, right or rear, with six sliding nuts on each face. The VPB is intended to be fitted on the back of any standard rack system and can be mounted vertically where space is available that is best suited to your installation. The VPB can be mounted horizontally also if required for a different purpose other than a rack system.

Although there are various methods through which the VPB could be mounted on the back or side of a vertical rack, the instructions provided here only show a single method of mounting the VPB for illustration purposes. Please Note if your rack has cage nut cut-outs already available then the VPB could be bolted to the cage nuts rather than a separate M5 nut.

Packaging

The parts and accessories required are listed below.

Included in the box;

6x M4x6 screws
3x Mounting plates

Not included in the box;

3x M5 Bolts
3x M5 Nuts
3x M5 Crinkle Washers

Instructions

The mounting instructions are all given below. However, the mounting nuts and bolts are not provided and will need to be sourced from your usual suppliers.

Mounting slots dimensions

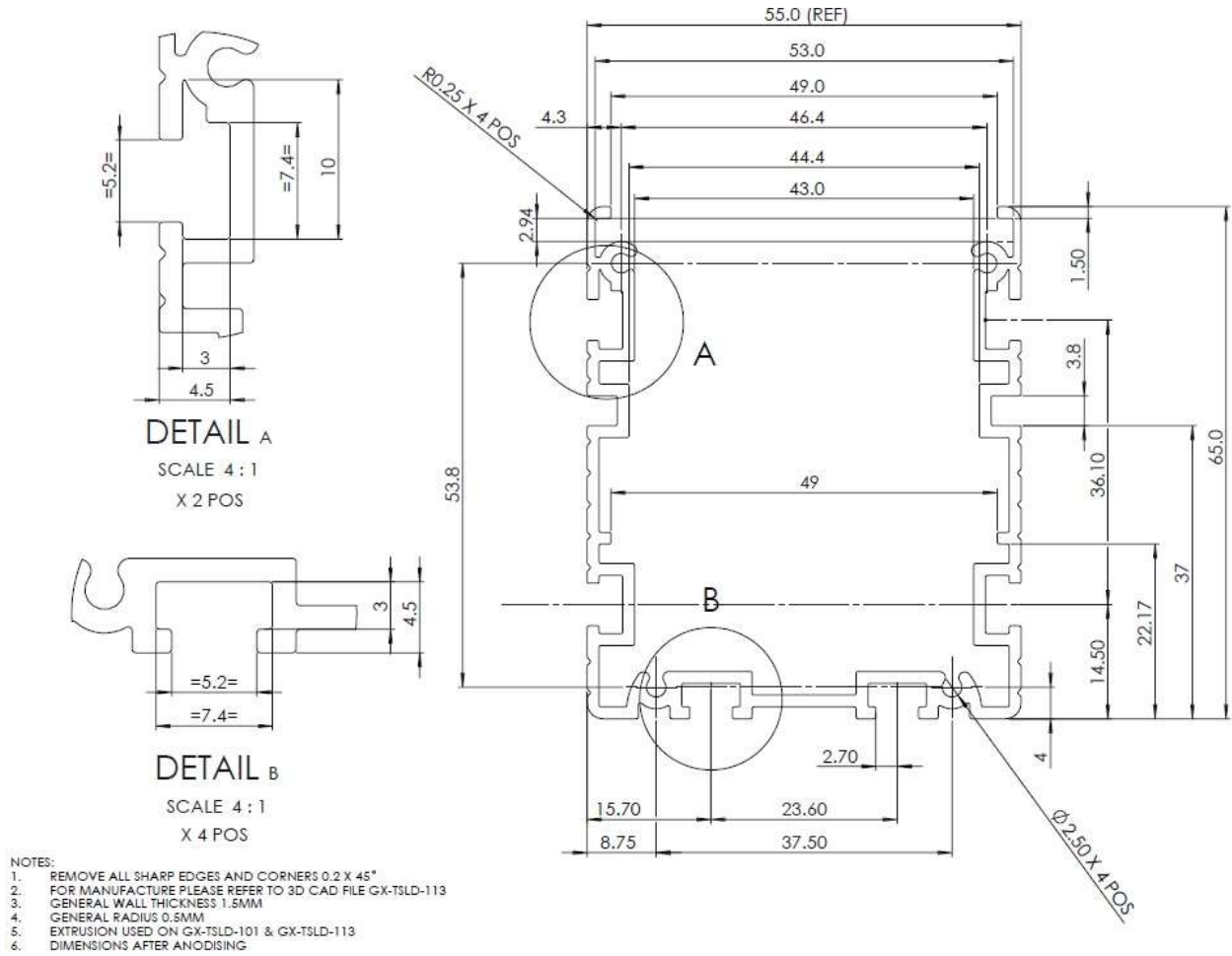

Mounting Bracket Dimensions

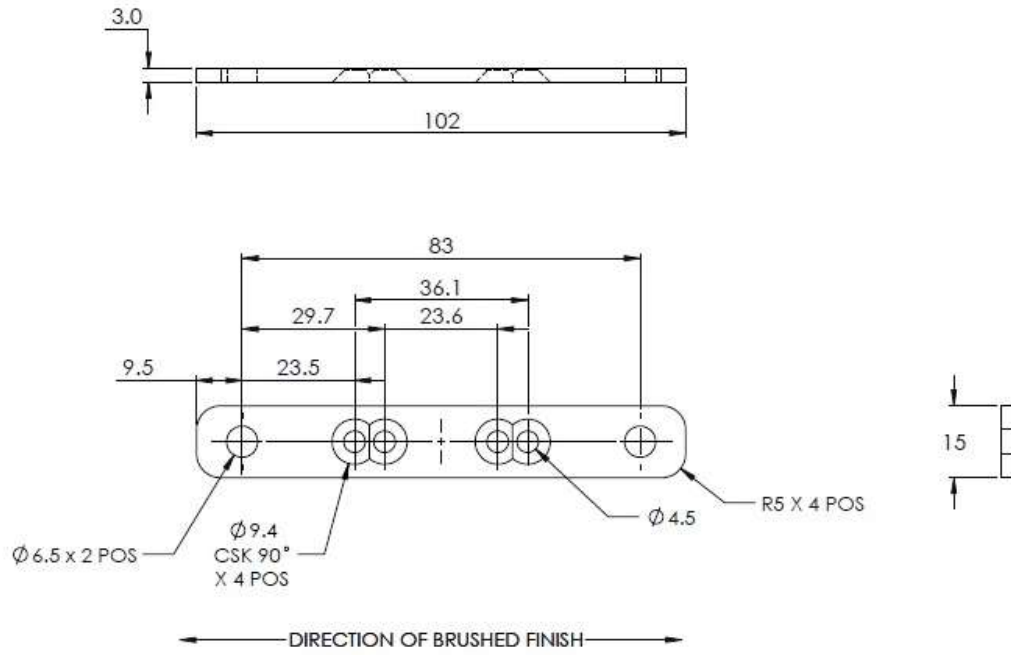

Please follow the steps below to mount the VPB to the back of a rack.

1. Fix the three mounting brackets to VPB as shown below in images 1 – 4. Please read each text box for step by step instructions.

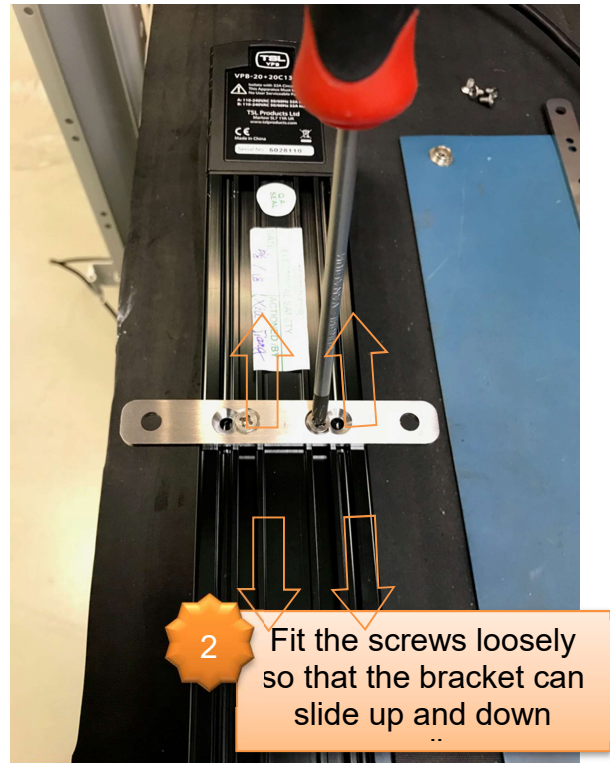
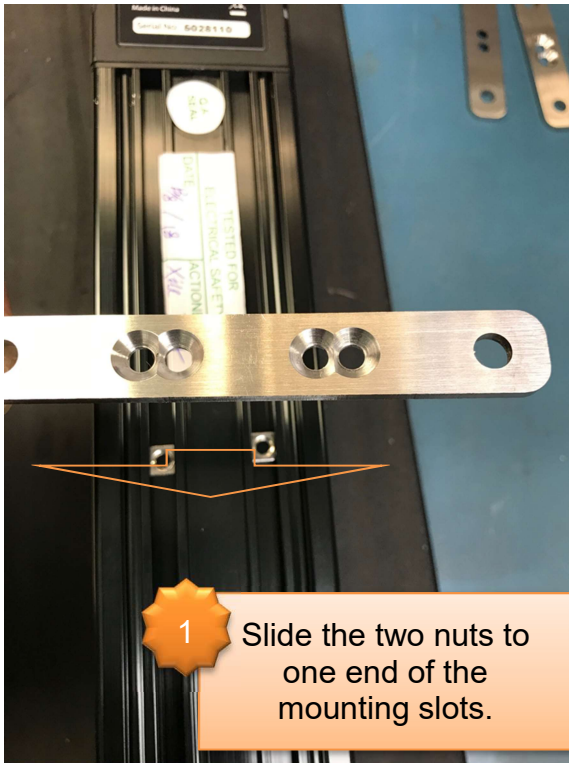

2. Similarly fit the other two mounting brackets loosely, one in the centre and one towards the other end.

3. Measure the distance between the mounting holes of your rack. For example, in my case they were 22.2cm apart and I had to mount my panel between 7 holes. The centre bracket at 88.8cm and the third one at 155.4cm.

Please note: The mounting brackets of VPB can extend up to 167cm apart.

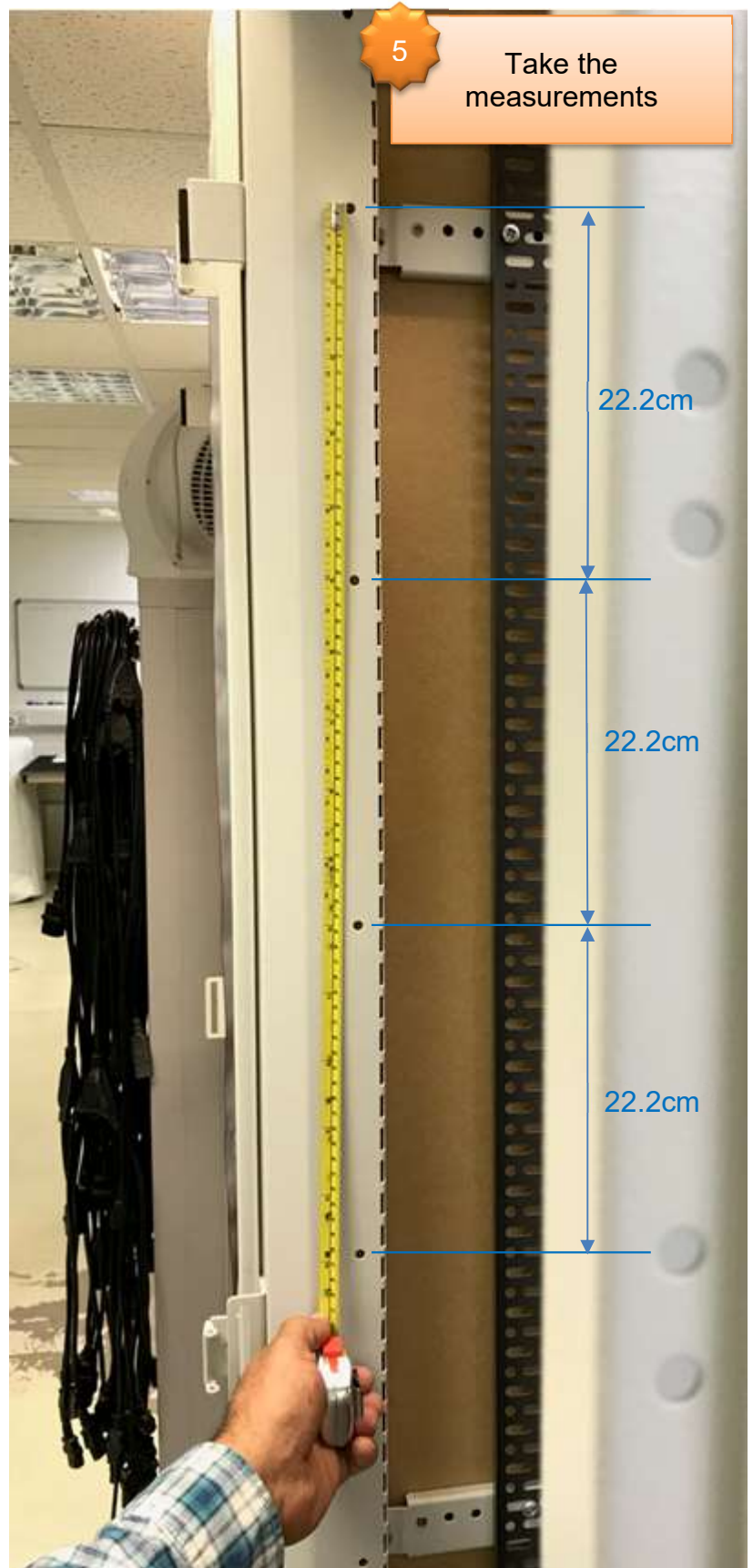

4. Hold and align the nuts behind the mounting holes as shown below with your fingers or a masking tape;

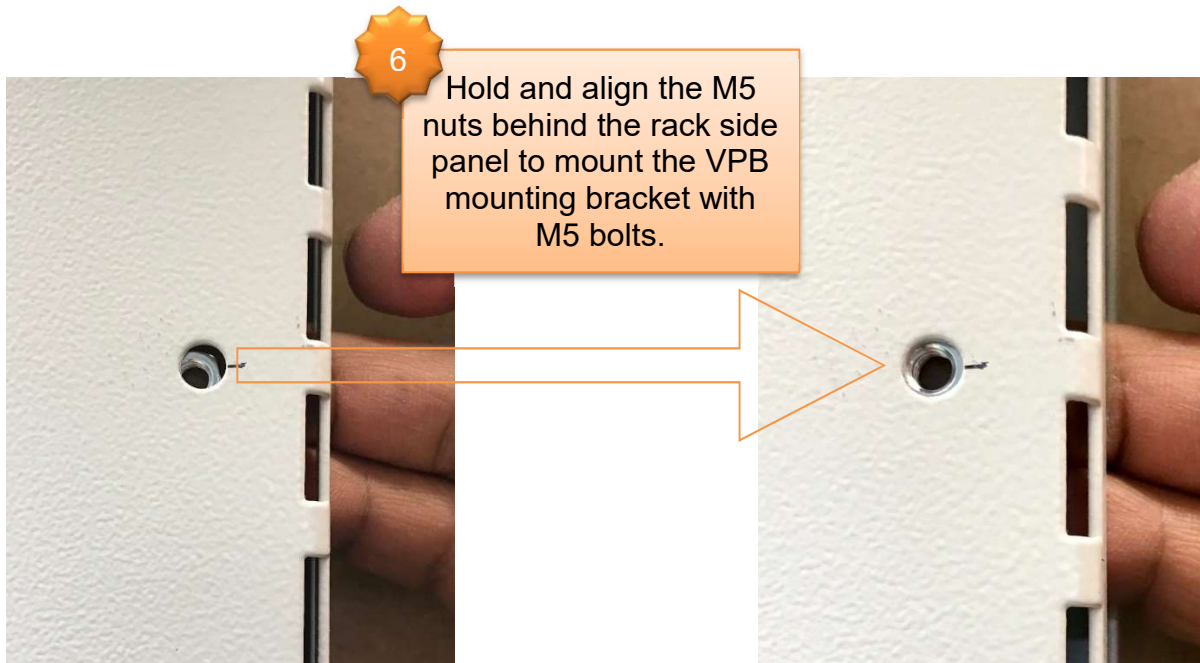

5. Fit the M5 bolt through the VPB mounting bracket and tighten it to secure the panel.



6. Fit the centre mounting bracket with M5 nut and bolt.

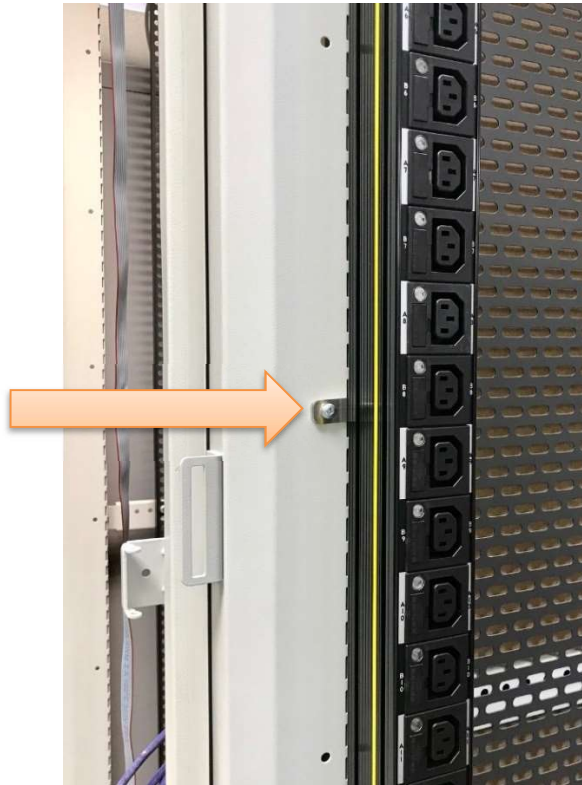

7. Fit the third mounting bracket with M5 nut and bolt.

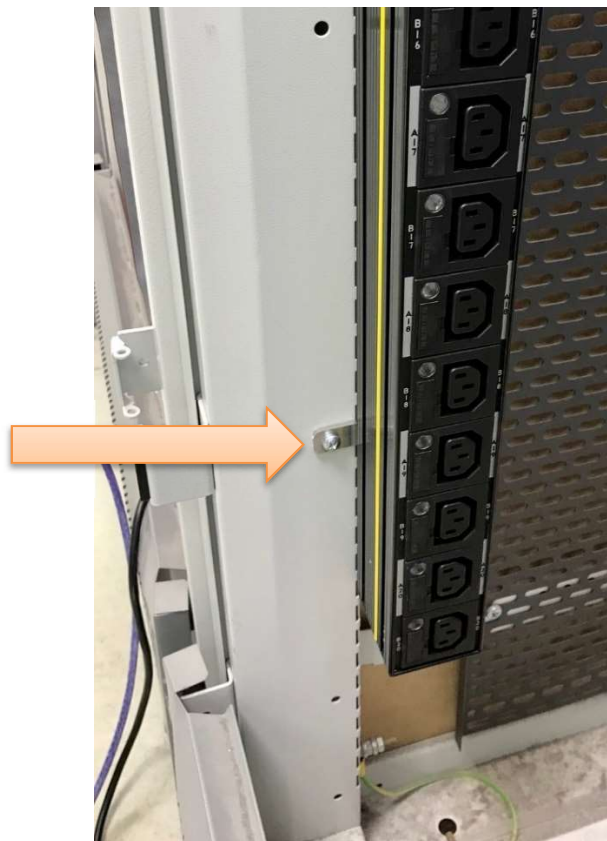

8. Mounting brackets fitted and VPB is now ready to use.

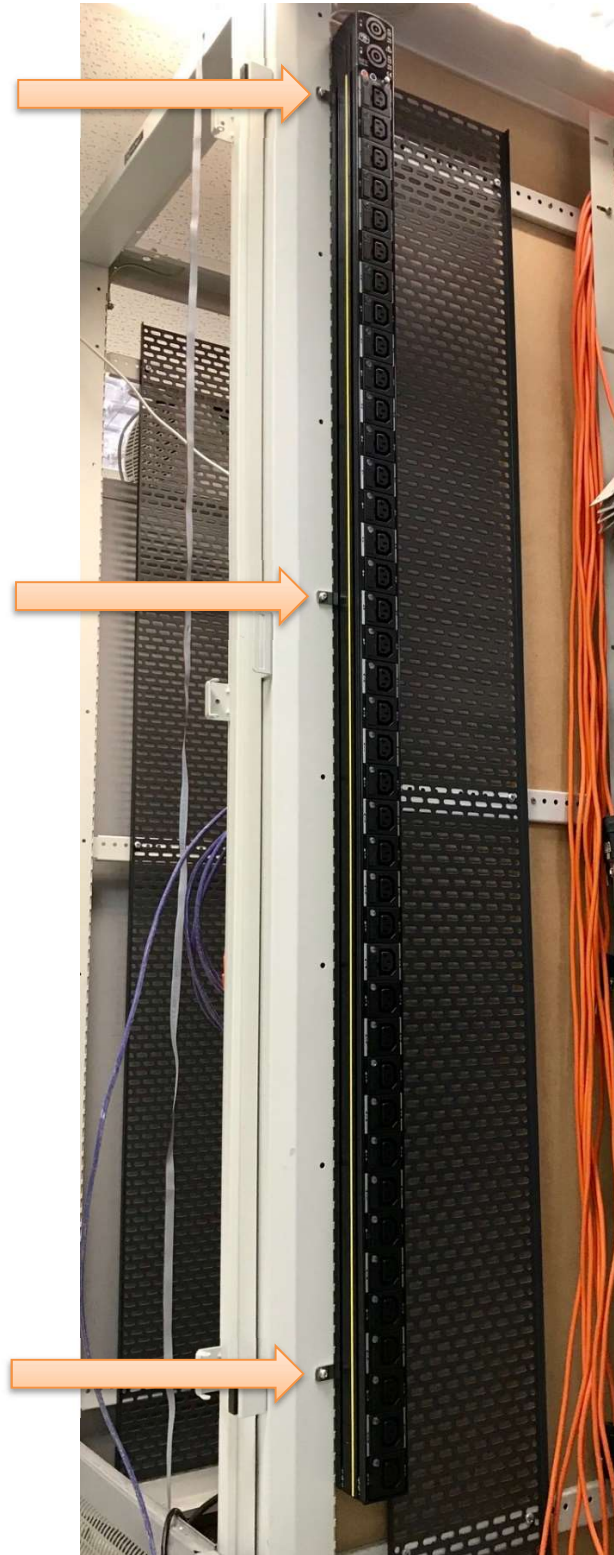

N.B. The VPB should be earthed for safety reasons to avoid electric shock hazards. You may fit the VPB panel sideways also facing inwards to the back the units or outwards facing away from the units.

6.0 Specifications

Input 2 x 110-240V AC 50/60Hz Max load 32A

Connector 32A 2 x Neutrik NAC3MP-HC 32A 250VAC

Mating connectors (not supplied by TSL Products) Neutrik NAC3FC-HC
<https://www.neutrik.com/en/product/nac3fc-hc>



NAC3FC-HC

powerCON 32 A cable connector

The 32 A powerCON is an extremely robust and reliable locking single phase AC appliance cable connector for high current capacity (32 A rated). It is conceived as a non-standardized 3 pole connection system without breaking capacity to serve the needs of high power distribution systems and supplies for professional audio and lighting equipment and installations. The connectors comprise of contacts for phase, neutral and protective earth (ground) conductors rated for currents up to 32 A and for voltages up to 250V.

Output 110-240V AC Max load 10A per outlet, fused on front panel.

Connectors 40 x C13 IEC 3 pin

Fuses 40 x 10A 250V AC Ceramic Anti surge 20mm