



eAMP1-8M
eAMP1-16M

1RU Dual Input 3G/HD/SD SDI Audio Monitor

User Guide

Part Number 821843, Revision A



This publication is protected by federal copyright law. No part of this publication may be copied or distributed, stored in a retrieval system, or translated into any human or computer language in any form or by any means electronic, mechanical, manual, magnetic, or otherwise, or disclosed to third parties without the express written permission of Wohler Technologies.

Reproduction

Licensed users and authorized distributors of Wohler Technologies, Inc. products may copy this document for use with Wohler Technologies., Inc. products provided that the copyright notice above is included in all reproductions.

Customer Support

Wohler Technologies, Inc.
1280 San Luis Obispo Ave
Hayward, CA, 94544
Phone: 510-870-0810
Web: www.wohler.com
Sales: sales@wohler.com
Support: support@wohler.com

Disclaimers

Even though Wohler Technologies, Inc. has tested its equipment and software, and reviewed the documentation, Wohler Technologies, Inc. makes no warranty or representation, either express or implied, with respect to software, documentation, their quality, performance, merchantability, or fitness for a particular purpose.

In no event will Wohler Technologies, Inc. be liable for direct, indirect, special, incidental, or consequential damages resulting from any defect in the hardware, software, or its documentation, even if advised of the possibility of such damages.

Some states do not allow the exclusion or limitation for incidental or consequential damages, so the above exclusion or limitation may not apply to you.

PDF

All text strings appearing in [this shade of blue](#) are hyperlinks.

Other Technologies and Products

Google Chrome is a registered trademark of Alphabet Inc.
Microsoft Windows and Internet Explorer are registered trademarks of Microsoft Corporation.
Dolby is a registered trademark of Dolby Laboratories, Inc.

All product names, logos, and brands are property of their respective owners. All company, product and service names used in this document are for identification purposes only. Use of these names, logos, and brands does not imply endorsement.

Last Update

November 9, 2023

TABLE OF CONTENTS

Table of Contents

User Guide	1
TABLE OF CONTENTS	3
Table of Contents	3
CHAPTER 1: Installation	6
Introduction	6
Overview	6
Safety	6
Instructions	6
Safety Symbols	7
Mounting	7
Heat Dissipation	7
Sympathetic Vibration	8
Mechanical Bracing	8
Electrical Interference	8
Power	8
Compliance	8
FCC	8
ICES-003	8
CHAPTER 2: Local Operation	9
Operation	9
OPTe Package Upgrade	9
Dolby Package Upgrade	10
Startup	10
Front Panel	10
Model Differences	11
Rear Panel	12
Channel Meters and Touch Operations	13
Menu / Option Touchscreen	15
Main Menu	16
Loudness Menu	16
Loudness Meter	16
Loudness Settings	18
Source Select	20
Presets	21
All Presets	21
Preset Favorites	22
Unit Settings	23
Speaker Options	24
Unit Configuration	25
Phase Configuration	26
Analog Configuration	27
Meter Scales	28

System Options Menu	30
Network Settings.....	30
System Reboot	32
System Update	33
Factory Reset	34
System Information.....	35
Passcode Settings	36
Forgotten Passcode	38
CHAPTER 3: Technical Info	39
CHAPTER 4: The eAMP1-8M/16M Web GUI	43
Web Browser / Control Device.....	43
First Time IP Assignments	43
Peer-to-Peer Connection.....	43
Network Connection.....	44
Network Setup.....	45
Dashboard	46
Audio Meters	50
System Preferences.....	51
System Audio Clock Reference	51
Loudness Configuration Tab	52
Phase Indicator Configuration Tab.....	53
Front Panel Configuration Tab	54
Preset Management.....	57
Global Output Routing.....	61
Destination Outputs.....	61
Source Inputs	62
Output Options	62
Typical Questions Regarding Global Output Routing.....	63
What signal outputs can be controlled using the Global Output Routing feature?.....	63
How do I route whatever is being monitored to the XLR?.....	63
How do I have a downmixed pre-fade output on the Analog XLRs combined with a post-fade output on the Speaker/Headphone?.....	63
How do I make the XLR outputs follow the Audio Meter screen solos & mutes while the Speaker/Headphone does not?.....	64
How do I route only specific monitored channels to the Analog XLR outputs?	64
How do I keep the internal speakers muted and have audio only on the analog XLR outputs?	64
How do I ensure that the outputs are automatically muted when the Headphone jack is inserted?.....	65
How do I ensure that my outputs are pre-faded but follow the solo-mutes on the web interface? This will allow us to monitor only the unmuted/solo Audio Meter channels on amplified stereo speakers connected to the Analog XLR's.	65
Preset Replication.....	66
Import/Export Presets.....	68
Export Configuration	68
Import Configuration	69
System Setup	70
System Information	70
Licenses.....	71

Factory Reset	72
Reboot System	73
APPENDIX A: Software Upgrades.....	74
Introduction	74
Download the Software	74
Update Methods	74
Local Update from the Front Panel	75
Updating via the Web GUI using a Flash Drive	77
Updating an eAMP1-8M/16M Remotely	79
Updating Multiple Units Remotely	81
APPENDIX E: API Documentation	84
Introduction	84
API: Presets	84

CHAPTER 1: Installation

Introduction

Overview

The eAMP1-8M and eAMP1-16M Audio Monitors are 1RU multichannel multi-source audio monitors, each with two switched 3G-SDI inputs. These and the associated other eAMP1-Series monitors allow the customer to select a model with the exact channel and input source capabilities needed for an economical cost.

The eAMP1-8M/16M is compact and simple to operate, with straightforward controls. It has a wide touch screen LCD display providing high resolution level meters. Any audio channels (or channel pairs) from the selected 3G/HD/SD SDI audio/video source stream may be monitored. Either 8 or 16 channel meters can be displayed, depending upon the model.

With the purchase of the OPTe Package option, monitoring setups are created and configured using local menus and a web browser over a network connection to the integral web server of the eAMP1-8M/16M. The web server will also allow you to view the audio meters remotely. Purchase of the OPTe Package, also enables purchase of the OPT-DOLBY Package option for Dolby® D, DD+, and E bitstreams monitoring. In other words, OPTe Package purchase is required prior to purchase of the OPT-DOLBY Package.

Safety

Instructions

1. Read, keep, and follow all of these instructions; heed all warnings.
2. Do not use this equipment near water.
3. Use only a dry cloth to clean the equipment.
4. Do not block any ventilation openings.
5. Do not install near any heat source such as a radiator, heat register, amplifier, or stove.
6. Do not attempt to plug the unit into a two-blade outlet (with only two prongs of equal width).

Important:

By design, the supplied AC mains power cord will only plug into a three-prong grounded outlet for your safety. If the plug does not fit into the outlet, contact an electrician to replace the obsolete outlet.

7. Protect the power cord from being walked on or pinched, particularly at plug connection on the equipment and at the socket.
8. Use only the attachments/accessories specified by the manufacturer.
9. Unplug the equipment during lightning storms or when unused for long periods

of time.

10. Refer all servicing to qualified service personnel. Servicing will be required under all of the following conditions:
 - a. The equipment has been damaged in any way, such as when the power-supply cord or plug is damaged.
 - b. Liquid had been spilled or objects have fallen onto the equipment.
 - c. The equipment has been exposed to rain or moisture.
 - d. The equipment does not operate normally.
 - e. The equipment has been dropped.

Safety Symbols

WARNING:

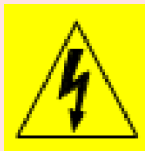

The symbol to the left warns of electric shock hazard inside the unit. Disconnect the power cord before removing access panels when installing upgrades. Only qualified service personnel are to operate the equipment with covers removed, and are to exercise caution to avoid personal injury.

Mounting

The unit is designed for a standard 19" rack. Install it at ear/eye level for best high frequency response and visual observation of the display screen. Please adhere to the following clearances:

Table 1-1: Clearance Recommendations

Clearance	Surface
24"	Front
3"	Rear
2"	Sides
1.75"	Top and Bottom (if either radiates heat)
0"	Top and Bottom (if no heat)

Heat Dissipation

The ambient temperature inside the mounting enclosure should not exceed 40° Celsius (104° Fahrenheit). Adjacent devices can be rack mounted (or stacked) in proximity to the unit if this temperature is not exceeded. Otherwise, allow a 1RU (1.75"/44.45mm) space above and below the unit for air circulation.

Important

Heat generated by the class D power amplifiers, power supplies, and other components is vented by slots in the sides and back of the unit. Therefore, as a safety precaution, you must allow proper ventilation on these surfaces.

Sympathetic Vibration

Sympathetic vibration from other equipment (cables, etc.) in the rack may be serious enough to interfere with the unit's sound quality. If you experience sympathetic vibrations, use thin card stock, felt, foam, or weather-stripping between the vibrating surfaces. Tie loose cables securely with cable ties.

Mechanical Bracing

The 1RU chassis is securely attached to the front panel. In addition, the chassis has mounting tabs through which you attach it to the rack rail. This feature will reduce or eliminate rear bracing requirements in many mobile/portable applications. The weight of internal components is distributed fairly evenly around the unit.

Electrical Interference

Be careful to avoid mismatched cable types and other similar causes of undesired reflections in digital signal systems. If severe enough, such reflections can result in corruption of the digital data stream. As with any audio equipment, maximum immunity from electrical interference requires the use of shielded cable; however, satisfactory results can sometimes be obtained without it. The internal circuitry ground is connected to the chassis.

Power

The unit connects to an AC mains power source (100 to 240 VAC, 65W, 50/60Hz) using an IEC power cord.

When the mains plug or appliance coupler is used as the disconnect device, the disconnect device should remain operable.

Compliance

FCC

This equipment has been tested and found to comply with the limits for a Class A digital device, pursuant to part 15 of the FCC Rules. These limits are designed to provide reasonable protection against harmful interference when the equipment is operated in a commercial environment. This equipment generates, uses, and can radiate radio frequency energy and, if not installed and used in accordance with the instruction manual, may cause harmful interference to radio communications. Operation of this equipment in a residential area is likely to cause harmful interference, in which case users will be required to correct the interference at their own expense.

ICES-003

This Class A digital apparatus complies with Canadian ICES-003.

Cet appareil numérique de la classe A est conforme à la norme NMB-003 du Canada.

CHAPTER 2: Local Operation

Operation

The eAMP1-8M/16M can be operated easily and simply from controls on its front panel, as described in this chapter. With the addition of the optional OPTe Package, it may also be accessed remotely in two ways, via the Wohler Web GUI for administrative purposes or by third party equipment via Application Programming Interface (API) commands. The Wohler Web GUI is described in Chapter 4 of this manual. The API commands are described in Appendix E of this manual.

OPTe Package Upgrade

The optional licensed OPTe Package Upgrade provides a number of powerful features beyond basic audio monitoring. The additional features are as follows:

- **Loudness Monitoring:** Parameters relating to the setup of loudness measurement can be set up and adjusted. The loudness of an input signal can then be measured and displayed along with the input signal levels. Refer to sections further in this chapter and to the System Preferences section of Chapter 4.
- **Preset Management and Preset Replication:** Presets are setups that allow you to set up which channels of the various inputs are displayed on the meters and in which order. Presets can then be quickly selected as needed. These presets can be copied to other eAMP1-8M/16M units to simplify multiple system setups. Refer to the Preset Management and Preset Replication sections in Chapter 4.
- **Remote Meter Monitoring and Configuration:** Related meter channels may be grouped together and named for ease of monitoring. The meters may be monitored via the Wohler Web GUI. Refer to the Dashboard section in Chapter 4.
- **Passcode Protection:** The settings of the eAMP1-8M/16M may be protected from tampering or accidental changes. This is done using a Passcode. Refer to the Passcode Settings section of this chapter or the Front Panel Configuration Tab section in Chapter 4.
- **Application Programming Interface:** The eAMP1-8M/16M may be controlled by third party equipment via Application Programming Interface (API) commands. These API commands are described in Appendix E.

An optional license key must be purchased to add the OPTe Package. Refer to the System Setup section in Chapter 4 to install licenses.

Dolby Package Upgrade

The optional licensed Dolby Package Upgrade allows decoding and monitoring of Dolby® D, DD+ & E. It includes Wohler Zoom & metadata. **This option requires prior purchase of the OPT-e Package Upgrade.**

An optional license key must be purchased to add the Dolby Package. Refer to the System Setup section in Chapter 4 to install licenses.

Startup

The eAMP1-8M/16M will begin its startup process when it is connected to power. There is no power switch. It is normal for the product to require about 45 seconds to start up and be ready to use.

When the eAMP1-8M/16M completes its startup, the **Status** indicator will turn green. Depending upon optional settings, all channel pairs will either be in the muted condition or set in a predetermined way. You may then use the **Channel** control to enable only the program channels you want to hear.

Front Panel

Each model in the eAMP1-8M/16M series shares the same front panel, differentiated only by the total number of monitoring meters that can be displayed, either 8 or 16. The front panel is as shown in Figure 2-1.

Figure 2-1: Typical eAMP1-8M/16M Front Panel

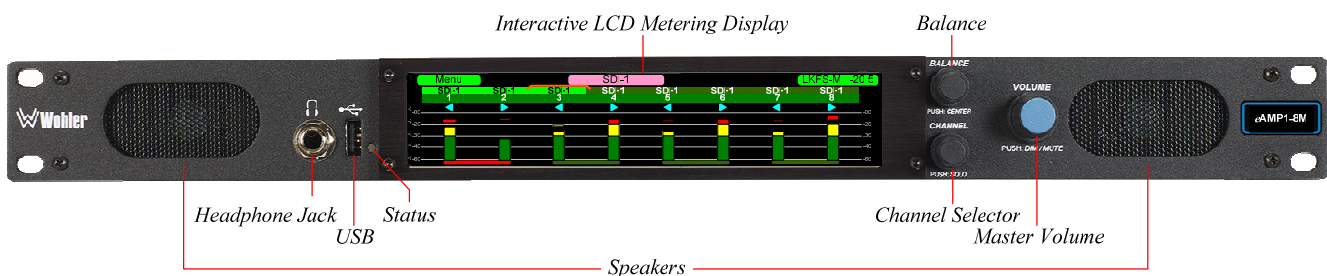

1. **Interactive LCD Metering Display:** A 7" LCD screen allows monitoring of audio with high resolution bar graph meters of up to 8 or 16 channels, depending upon model. Also displayed are stereo phase indicators.
2. **Speakers:** Local near field audio monitoring is achieved through the use of class D amplifiers. There are two (left/right) speakers. The speaker response may be adjusted with tone controls in the **Speaker Options** menu. Refer to the **Menu / Option Touchscreen** section of Chapter 2.
3. **Headphone Jack:** A 1/4" jack for an optional headphone is provided on the front panel. Speaker audio will be muted when headphones are plugged in. The speaker audio may optionally be set to not mute, using the Wohler Web GUI. Refer to the **Global Output Options** section of Chapter 4. If the speaker audio is set to mute

with headphone insertion, and a headphone is plugged into the Headphone Jack,

the following icon will appear at the top of the Audio Meter Display:



4. **Volume:** This controls the speakers, the headphone, and the analog outputs. As the **Volume** control is turned, a graphic appears at the top of the Audio Meter

Display screen, as follows:



Pressing the **Volume** control mutes the audio and a speaker muted icon appears at the top the Audio Meter Display:  This icon also displays whenever the **Volume** control is turned all the way counterclockwise.

5. **Balance:** This controls the relative left/right levels for the monitored stereo mix. Pressing the knob will bring the balance back to center. It controls the speakers, the headphone, and the analog outputs. As the **Balance** control is turned, a

graphic appears at the top of the Audio Meter Display as follows:

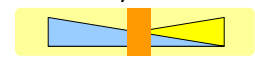

6. **Channel:** Turning this control moves a white selection box from channel to channel on the metering screen. Press the control to solo the highlighted channel. The box will turn blue and any other boxes will disappear. To remove the solo and return to the previous monitoring configuration, press the **Channel** control once again.
7. **USB:** This USB 2.0 Type A connector allows you to use a flash drive (not supplied) to perform software updates and copy system configurations to another eAMP1-8M/16M or to a PC. Refer to Appendix A of this manual to learn about performing a software update.
8. **Status:** This indicator lights green when the system is powered and ready for use. A solid or blinking yellow color indicates that the product is starting up. A red color indicates that a system update is taking place. Refer to Appendix A for procedures to update software.

Model Differences

Each eAMP1-8M/16M model is differentiated by the monitoring interfaces that it can support. The function of each connector on the rear panels is described in the next section. The following is a summary of the monitoring capabilities of each model:

- **eAMP1-8M:** The eAMP1-8M can monitor up to 8 channels selected from its input sources. It contains two 3G/HD/SD SDI inputs and outputs, along with a selected output for the chosen SDI input. As with all models, it contains a pair of Analog XLR outputs for the program being monitored or for your choice of any input channels.
- **eAMP1-16M:** The eAMP1-16M can monitor up to 16 channels selected from its input sources. It contains two 3G/HD/SD SDI inputs and outputs, along with a selected output for the chosen SDI input. As with all models, it contains a pair of Analog XLR outputs for the program being monitored or for your choice of any input channels.

Rear Panel

The Rear Panel is shown in Figure 2-2.

Figure 2-2: Rear Panel Connectors

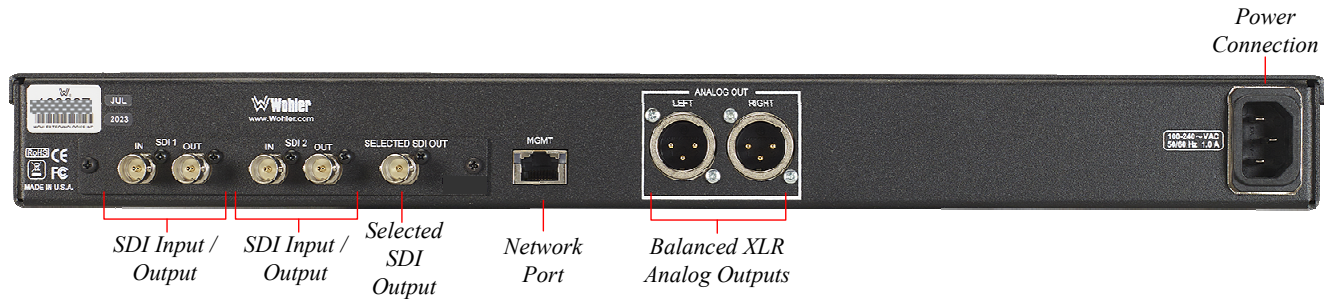

Power Connection: The eAMP1-8M/16M receives power from an AC inlet, which is a standard IEC receptacle for 100 to 240 VAC $\pm 10\%$, 50/60 Hz power connection. Four regional AC power cords, supplied according to shipping region, are available.

Important:

By design, the supplied AC mains power cord will only plug into a three-prong grounded outlet for your safety. If the plug does not fit into the outlet, contact an electrician to replace the obsolete outlet.

1. **SDI Input/Output:** These two BNC connectors accept and pass through the 3G/HD/SD-SDI input signals. Only one may be selected at a time for monitoring. They incorporate automatic frame rate detection and selection.
2. **Selected SDI Output:** This BNC connector outputs the 3G/HD/SD-SDI input signal that is selected for monitoring.
3. **Network Port:** This Ethernet port can connect to either a LAN or to a PC to let you perform metering, monitoring, and configuration remotely. The Wohler Web GUI is described in Chapter 4 of this manual. Third party equipment, which can use API commands to view and change product options, can also be plugged into this port. However, use of the API commands requires that the OPTe Package be purchased. The API is described in Appendix E of this manual.
4. **Balanced Analog Outputs:** These male XLR connectors provide two balanced analog outputs: Left and Right. The source of these signals is the mix of audio as monitored by the internal speakers or any input channels of your choice. These outputs can either be adjusted by the **Volume** and **Balance** controls or configured for a fixed line level output. The **Analog Outputs** are standard on the eAMP1-8M/16M. Refer to Figure 2-3 for the pinout of this connector.

Figure 2-3: Analog XLR-M Output Connections

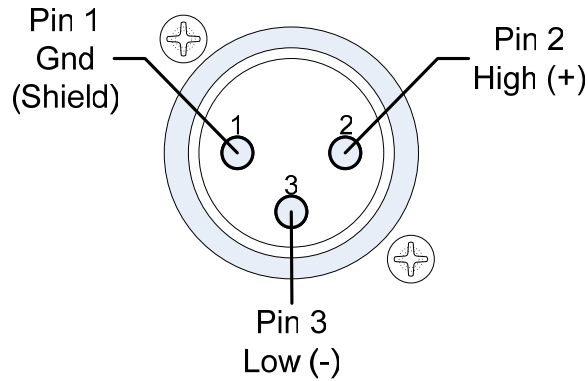

Channel Meters and Touch Operations

The audio mixer terminology of “solo” is used in this manual when referring to muting all but a specific audio channel or pair.

Audio meters are displayed on touchscreen LCD display(s) in up to 8 channel pairs, as shown in Figure 2-4.

Figure 2-4: Audio Level Meter Screen

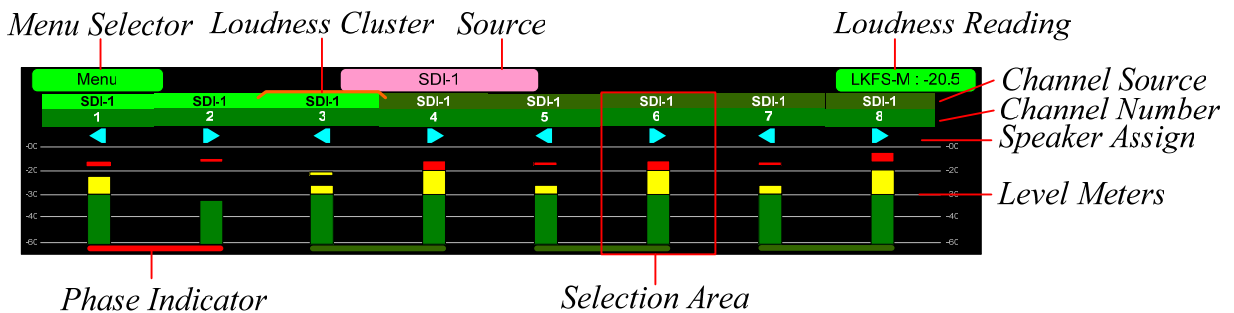

1. **Channel Source and Channel Number:** Above the level meters are the channel identifiers. They indicate the channel input source and consecutive channel numbers in the selected source.
2. **Speaker Assignment:** The speaker assignment for each channel is shown as follows:

◀ An arrow pointing to the left indicated that this is a left channel and will be monitored in the left speaker.

▶ An arrow pointing to the right indicated that this is a right channel and will be monitored in the right speaker.

■ A square indicates that this is a center channel and will be monitored

in both speakers.

3. **Source:** This indicates the input source of the displayed channel.
4. **Loudness Cluster Marker:** Loudness Measurement is available if the OPTe Package is purchased. This orange bracket marks which cluster is currently being measured for Loudness.
5. **Loudness Reading:** Loudness Measurement is available if the OPTe Package is purchased. This control displays the Loudness of the selected Cluster. It can also be touched to change which Cluster is being measured. To do this, touch the green **Loudness Reading** control. It will temporarily turn orange. You may then touch the meters in any other cluster. The **Loudness Cluster Marker** will then move to that cluster and its measurement will begin and be displayed. You may then touch the control again to return it to its green color, restoring normal touch functioning, or wait 15 seconds for it to time out.
6. **Selection Area:** Touching the meters of any channel pair will let you mute, un-mute, or solo the associated channel(s). Colored boxes surrounding the channel pair or channel indicate what operation is being performed. The following describes each function:
 - a. **Mute / Un-Mute Selection:** The Channel Label is bright green for each channel that is unmuted. Muting and un-muting by touching is an alternate action function. Multiple channels may be unmuted at once. Typically, when the eAMP1-8M/16M is first powered, all of the channels are muted.
 - b. **Channel Solo:** (Method 1) Touch for two seconds any channel you would like to solo. A blue box will then surround the channel and that will be the only one you hear. Any white boxes will disappear and any bright green Channel Labels will dim. Touching another channel will then move the blue box to it, and it will be soloed. Touch again to return the combination of monitored channel pairs to the way they were before you soloed the channel.
 - c. **Channel Solo:** (Method 2) Rotating the **Channel** control will move a white selection box from channel to channel. Press the **Channel** control to solo the selected channel. That channel alone will then be surrounded by a blue box and it will become the only channel being monitored. Press the **Channel** control again or touch the channel surrounded by the blue box to undo the solo and return the combination of monitored channel pairs to as it was before you soloed the channel.
7. **Phase Indicators:** At the bottom of each channel pair is a Phase Indicator. The indicators light a dull green if the channels in the pair are in phase or bright red if they are out of phase. Set which Phase Indicators appear using the **Phase Config Menu** or with the **System Preferences: Phase Indicator Configuration** tab in the Wohler Web GUI.
8. **Menu Selector:** Touching the **Menu Selector** opens the menu used to set up preferences for operation. Refer to the **Menu / Option**

Menu / Option Touchscreen

You may set most options or view a variety of system information using the self-contained menus. To access this, touch the **Menu** button which appears on the left of the level meter screen. Figure 2-5 is a diagram of the menu arrangement, a tree showing how to reach any menu from the **Main Menu**. Figure 2-6 shows the **Main Menu**.

Figure 2-5: Menu Tree

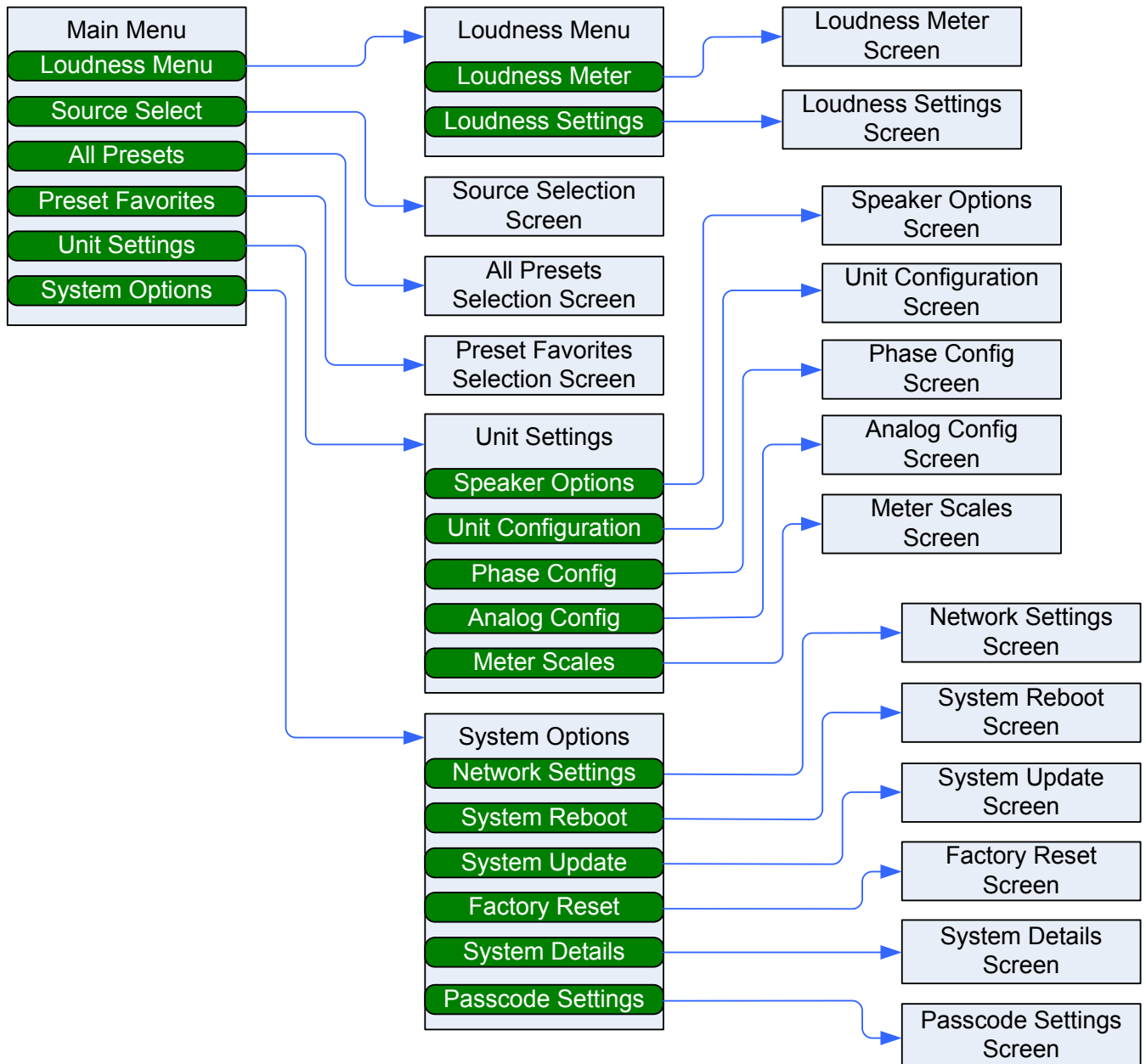

Main Menu

Touch the Menu button on the display to access the **Main Menu**. The **Main Menu** is shown in Figure 2-6. Note that depending upon whether the OPTe Package has been installed, some of the selections may not appear.

Figure 2-6: Main Menu

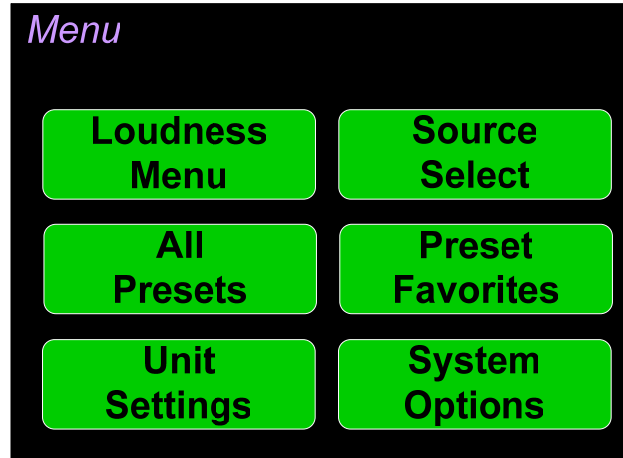

Loudness Menu

Loudness Measurement is available if the OPTe Package is purchased. Touch the Loudness Menu button to reach the Loudness Menu Screen, which allows you to make a selection of either the Loudness Meter Screen or the Loudness Settings Screen. The Loudness Menu Screen is shown in Figure 2-7.

Figure 2-7: Loudness Menu Screen



Loudness Meter

Loudness Measurement is available if the OPTe Package is purchased. Touch the **Loudness Meter** button on the Loudness Menu screen to reach the Loudness Meter Screen. The Loudness Meter Screen is a more detailed view of the Loudness Measurement. It is displayed along with the channel meter screen and is shown in Figure 2-8.

A box on the lower right of the screen shows the selected Loudness Source, as does the orange bracket on the Level Meters screen.

Figure 2-8: Optional Loudness Meter Screen

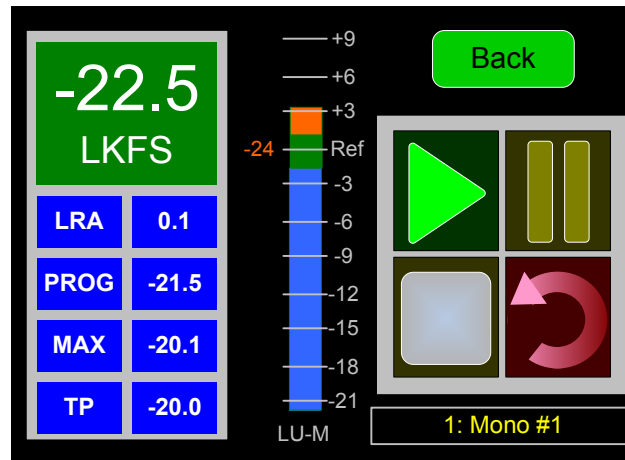

Note: In order to calculate loudness accurately, it is crucial that you correctly set the Channel Function for each channel. Depending upon the designated function of each channel, its signal levels will contribute differently to the Loudness calculation. Refer to the **Configuration | System Preference | Loudness Configuration** tab in the Web GUI.

The following data is available on the **Loudness Meter Screen**:

The Program Loudness (shown as -22.5 LKFS in the figure above) is shown digitally at the upper left of the screen as well as on the meter in the center. At the base of the meter in the center, one of three indications appears:

1. LU-M: This means that the Loudness Window is set to Momentary.
2. LU-S: This means that the Loudness Window is set to Short Term.
3. LU-C: This means that the Loudness Window is set to Custom. The Loudness Window is set in the Loudness tab in the Web GUI.

The LU Meter scale colors have the following meaning:

1. Blue: Loudness is lower than the Reference Level by the Alarm Tolerance.
2. Green: Loudness is within the Alarm Tolerance.
3. Orange: Loudness is greater than the Alarm Tolerance.

Below the digital Loudness meter, in the left column, the following parameters are also displayed:

1. The Loudness Range (LRA) is the measure of variation between the calculated loudest and softest passage over the program period (shown as LRA -0.1 above).
2. The Average Loudness is the average of all calculated loudness measurements made over the Program period (shown as PROG -20.5 above).
3. The Maximum Loudness is the maximum calculated loudness over the program period (shown as MAX -20.1 above).
4. The Maximum True Peak Loudness is the absolute loudest peak waveform over the program period (shown as TP -20.0 above).

Note: Further and more detailed descriptions of all of the above Loudness terms may be found in the ITU-R BS.1770-3 loudness standard.

The controls available on the Loudness Meter Screen are:

1. **Cluster Select:** You may change which Cluster is being measured by simply touching the green Loudness reading on the Audio Meter screen. It will turn orange and you will be able to touch other clusters and read their Loudness. Changing clusters will reset the loudness readings and start a new calculation on the newly selected cluster.
2. **Start:** When **Manual Mode** is selected in the Loudness Settings screen, from a stopped condition, the **Start** button will reset the gathered loudness data and begin a new reading. From a paused condition, data will not reset as monitoring is resumed.
3. **Pause:** The **Pause** button will temporarily stop or continue gathering loudness data. Data will not be reset using this control. While paused, Loudness will not be measured.
4. **Reset:** The **Reset** button will reset the gathered loudness data. If it is pressed while a loudness measurement is in progress, a new reading will then immediately begin.
5. **Stop:** When **Manual Mode** is selected in the Loudness Settings screen, the **Stop** button will stop gathering loudness data. Data will be held for viewing and not be reset using this control.
6. **Back:** Touch the **Back** button to go to the Loudness Menu.

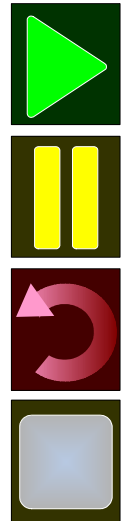

Loudness Settings

Loudness Measurement is available if the OPTe Package is purchased. Touch the **Loudness Settings** button on the Loudness Menu to display the **Loudness Settings** screen. This screen allows you to change between **Manual** and **Continuous** Monitoring Modes, and also to set the Alarm mode. It also provides a summary of various Loudness settings, as set in the **Configuration | System Preference | Loudness Configuration** tab of the Web GUI. Refer to Figure 2-9.

Figure 2-9: Optional Loudness Settings Screen

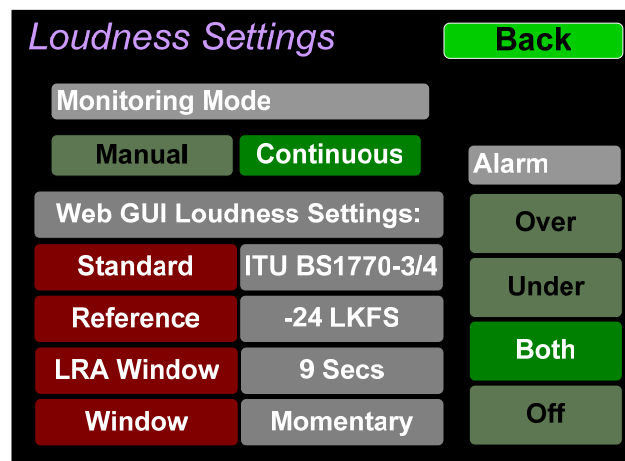

The controls and information available on the Loudness Meter Screen are:

Monitoring Mode:

1. **Manual:** Touch the Manual button to enable Manual Mode. This allows you to measure the loudness of a specific program or segment of a program, such as a commercial. In this mode, the **Start** and **Stop** button on the Loudness Meter screen can be manually used to begin and end a loudness measurement interval. The reading for that interval is then held on the Loudness Meter.
2. **Continuous:** Touch the **Continuous** button to enable Continuous Mode. In this mode, loudness readings are continually made. The **Stop** button on the Loudness Meter screen is not active.

Alarm:

1. **Over:** The Alarm indication will only appear when Loudness has exceeded the **Reference Level** by the **Tolerance** amount.
2. **Under:** The Alarm indication will only appear when Loudness is below the **Reference Level** by the **Tolerance** amount.
3. **Both:** The Alarm indication will only appear when Loudness has exceeded or is below the **Reference Level** by the **Tolerance** amount.
4. **Off:** The Alarm indication will not appear.

Web GUI Loudness Settings: These settings are included on this screen for reference only. They cannot be changed on this screen.

1. **Standard:** This is the loudness standard by which the loudness calculation is made.
2. **Reference:** This is the set point in the loudness measurement about which the determination is made as to whether an alarm should be displayed.
3. **LRA Window:** This is a moving window of time over which the loudness measurement is made.
4. **Window:** This may be set to **Momentary**, **Short**, or one of 22 values, ranging from one second to two hours.

Note: Further and more detailed descriptions of all of the above Loudness terms may be found in the ITU-R BS.1770-3 loudness standard.

When you have completed reviewing or changing the settings, touch the **Back** button to return to the Loudness menu.

Source Select

Touching the **Source Select** selection on the **Main Menu** proceeds to the **Source Select** menu, which shows all of the possible sources. The selected source is shown in a light color. You may simply touch another source in this menu to switch to it. Figure 2-10 shows the Source Select Menu.

Figure 2-10: Source Select Menu

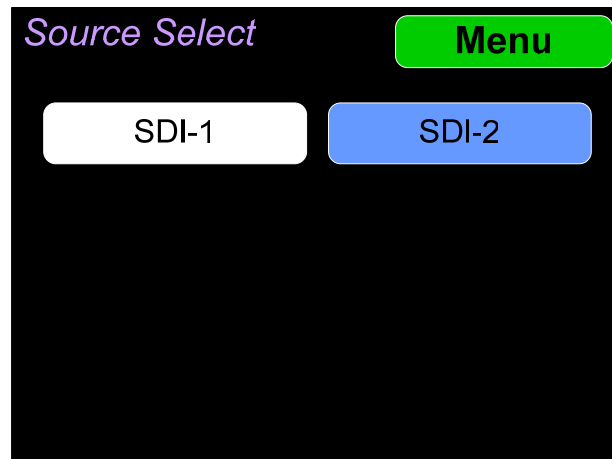

Touch **Menu** to exit this menu.

Figure 2-11: Additional Selection Screen:

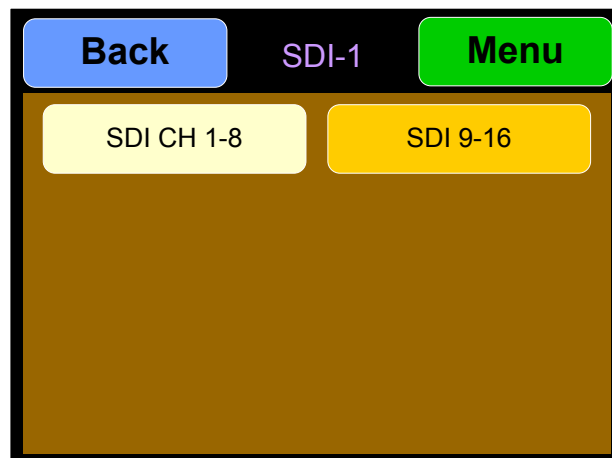

Touch **Back** to return to the **Source Select** menu or touch **Menu** to return to the **Main Menu**.

Presets

The Presets feature is available if the OPTe Package is purchased. Presets are pre-arranged input and monitoring setups that can be used to monitor a variety of combinations of inputs. They may be set up to allow quick and easy selection of monitoring configurations for various productions and situations. If you have not set up any Presets, use the Configure Presets page in the Web GUI to do so. Refer to Chapter 4. Or, if you prefer not to set up any Presets, simply monitor the sources directly using the Source Select button in the Menu.

All Presets

Touch the **All Presets** button to display the All Presets Group Selection screen as shown in Figure 2-12. If no Presets have been created, the screen in Figure 2-14 appears instead.

Figure 2-12: All Presets Screen - Group Selection

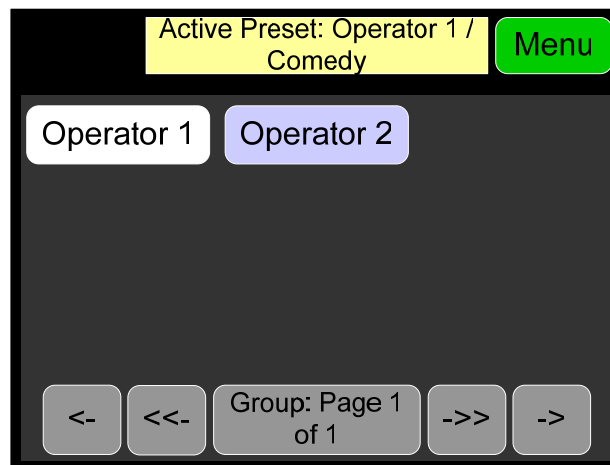

The Presets are normally arranged into Groups. Use this screen to select which Preset-containing Group to examine. After selecting one of the Groups, the Preset Selection screen shown in Figure 2-13 is shown.

Figure 2-13: All Presets Screen - Preset Selection

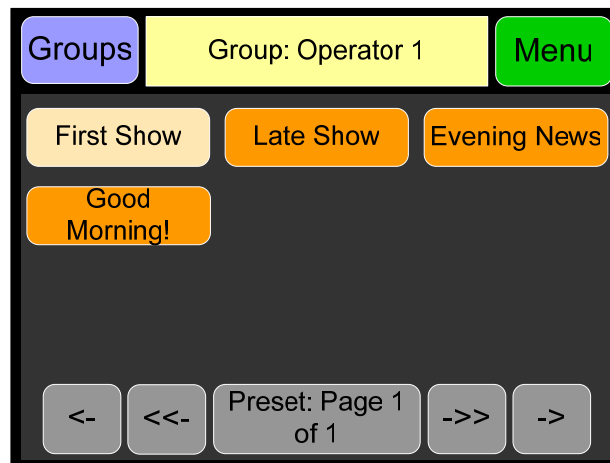

To select a Preset, touch the associated button. After a quick 2-second delay, the

metering screen will display the channels contained in that source.

To return to the All Presets Group Selection screen instead, touch the **Groups** button. To return to the Menu without making a selection, touch the **Menu** button.

Figure 2-14: All Presets Screen - No Presets

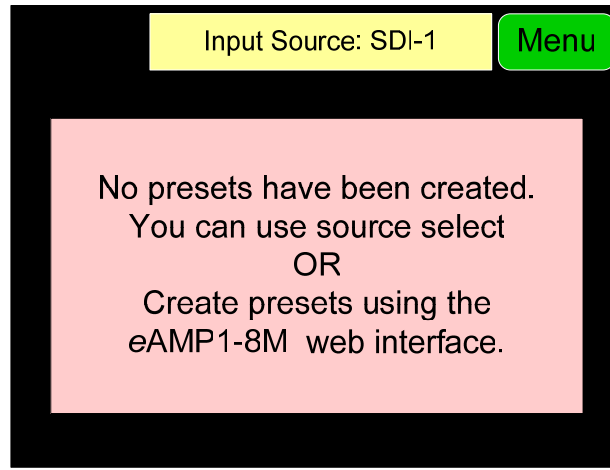

To return to the Menu from this screen, touch the **Menu** button.

Preset Favorites

Touch the **Preset Favorites** button to display the Preset Favorites screen. This shows the Presets that you have designated as Favorites. Refer to the Dashboard section of Chapter 4. Generally, these are frequently used Presets that you want to separate out from the possibly many other Presets in the system. The Preset Favorites screen is shown in Figure 2-15.

Figure 2-15: Preset Favorites Screen

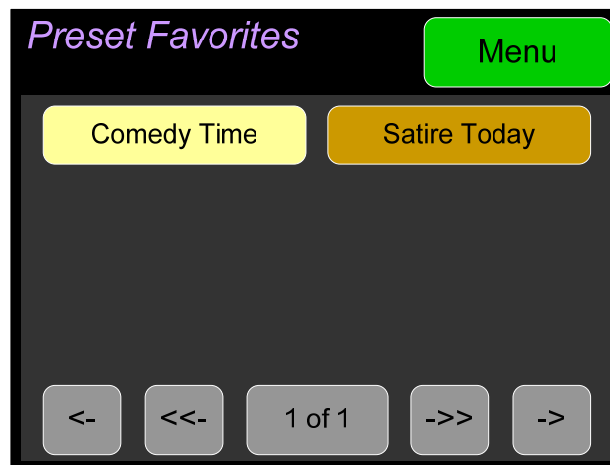

In this screen, the currently selected Preset is shown in bright yellow. Touch any Preset to select it. To exit this screen without making a selection, touch **Menu**. If no Favorite Presets have been designated, this screen will appear as shown in Figure 2-16.

Figure 2-16: Preset Favorites Screen - No Favorites

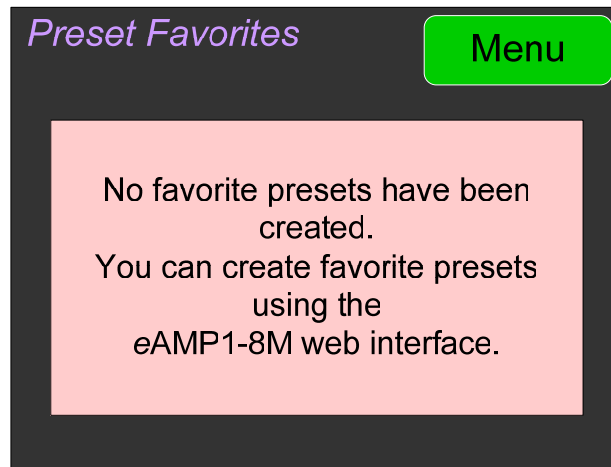

Unit Settings

Touching the **Unit Settings** selection on the **Main Menu** screen proceeds to the **Unit Settings Menu**, which contains additional menu selections. The **Unit Settings Menu** is shown in Figure 2-17. This is an intermediary menu which leads to other menus and screens.

Figure 2-17: Unit Settings Menu

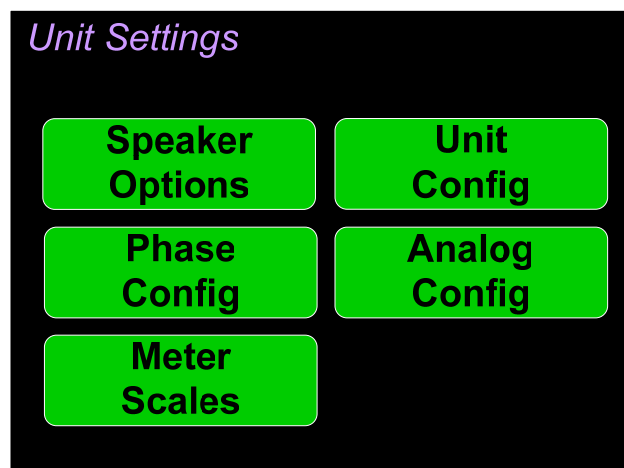

Speaker Options

Touching the **Speaker Options** selection on the **Unit Settings** Menu screen proceeds to the **Speaker Options** screen. The controls on this screen affect various characteristics of the monitored audio as heard on the eAMP1-8M/16M. This screen is shown in Figure 2-18.

Figure 2-18: Speaker Options Screen

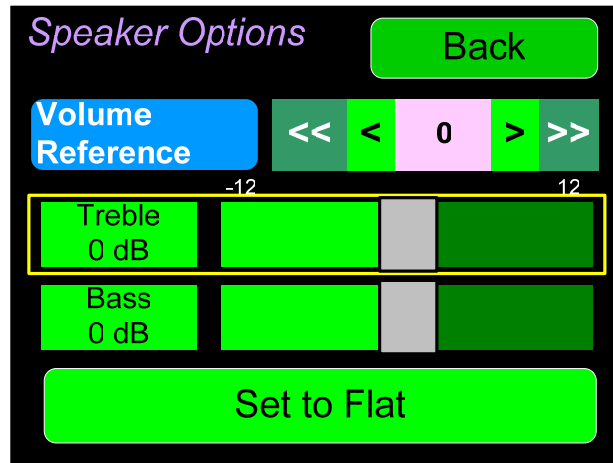

The controls function as follows:

1. **Volume Reference:** The **Volume Reference** setting controls the attenuation level of the internal speakers. The value ranges from 0 to -255 dB. 0 results in full volume and -255 causes the speakers to be muted.
2. **Treble:** This tone control adjusts the high frequency speaker audio response from -12 dB to +12 dB. Lowering **Treble** compensates for high frequency pre-emphasis or removes sibilance effects. Increasing **Treble** will add "sizzle" to the sound and bring high-pitched sounds out of the mix. The control can be touched and moved left or right to adjust in 2 dB increments. After touching the **Treble** control, the **Channel** knob can also be turned to make the adjustment.
3. **Bass:** This tone control adjusts the low frequency speaker audio response from -12 dB to +12 dB. Lowering **Bass** will unmask midrange band sounds, while increasing **Bass** will make the sound "fatter". The control can be touched and moved left or right to adjust in 2 dB increments. After touching the **Bass** control, the **Channel** knob can also be turned to make the adjustment.
4. **Set to Flat:** Touching this button will set the **Treble** and **Bass** controls to their midpoint, resulting in a flat response with 0 dB increase or decrease in treble and bass response.

Touch **Back** to exit this screen.

Unit Configuration

Touching the **Unit Config** selection on the **Unit Settings** Menu proceeds to the **Unit Config Menu**. This menu is shown in Figure 2-19.

Figure 2-19: Unit Configuration Menu



The controls function as follows:

1. **Brightness:** This setting adjusts the brightness of the display screen. Touch the left pointing arrow to dim the brightness or touch the right pointing arrow to increase the brightness.
2. **Meter Mode:** This setting determines how many meters will be displayed. It is available on the eAMP1-16M only and allows a choice of either 8 or 16 meters.

Touch **Back** to exit this menu.

Phase Configuration

Touching the **Phase Config** selection on the **Unit Settings** Menu proceeds to the **Phase Config Menu**. This menu is shown in Figure 2-20 for the eAMP1-8M and eAMP1-16M.

Figure 2-20: Phase Configuration Menu

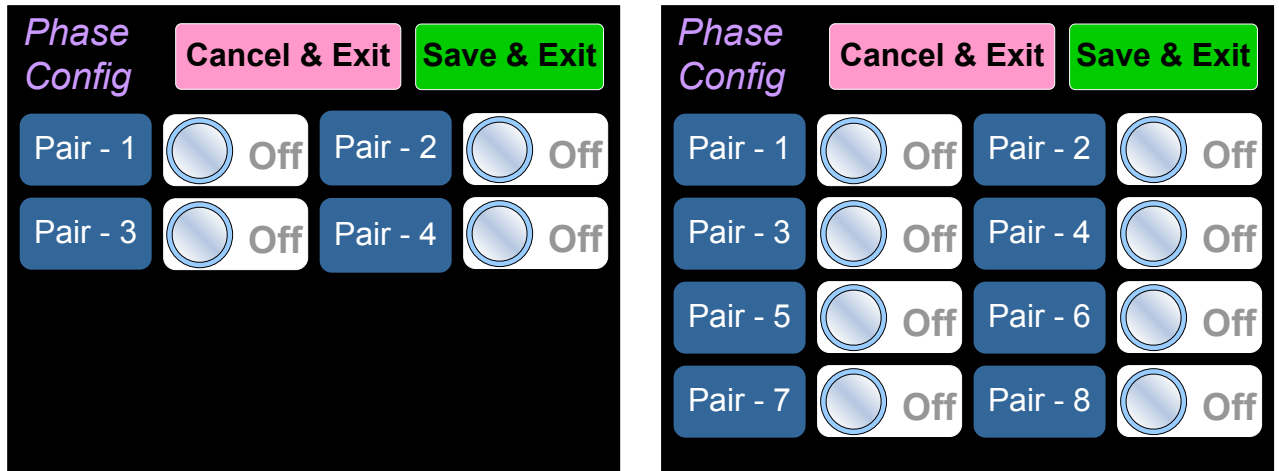

The controls function as follows:

1. **Pair 1 - 4 or 1 - 8:** These switches allow you to select which channel pairs will receive a phase meter on the **Metering Screen**. Generally, it is useful to monitor the relative phase of stereo pairs. However, sometimes each channel of a pair is unrelated to each other. This can be because the channels are used to convey two independent monophonic signals or that one channel may be a Center channel and the other may be a Low Frequency Effects channel. In these instances, the Phase Indicator would almost always indicate an out of phase condition. Because this would be a needless distraction to the operator, switches are provided on this screen to individually turn phase monitoring for each channel pair on or off.
2. **Cancel & Exit:** If you decide that you do not want to keep the settings you have made on this screen, touch the **Cancel & Exit** button to discard the changes and return to the **Unit Settings** menu.
3. **Save & Exit:** When you have finished making the changes you want on this screen, touch the **Save & Exit** button to save the changes and return to the **Unit Settings** menu.

Analog Configuration

Touching the **Analog Config** button in the **System Options Menu** displays the **Analog Config** screen. Contained in this menu is an **Analog Reference** as illustrated in Figure 2-21. The parameters set on this screen pertain to the **Analog Output** XLR connectors on the rear panel of the eAMP1-8M/16M.

Figure 2-21: Analog Configuration Menu

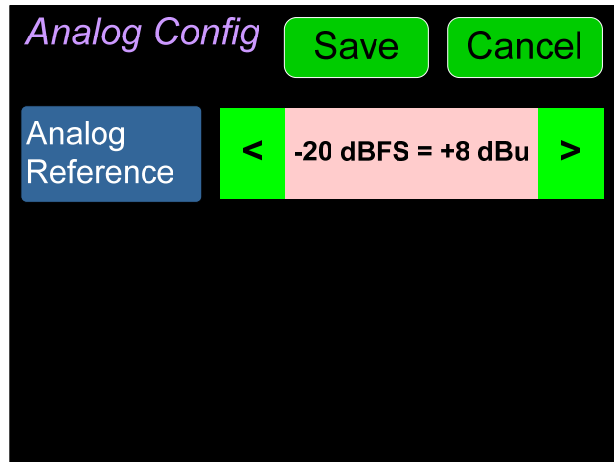

There is only one setting on the **Analog Reference** menu:

1. **Analog Reference:** This setting adjusts the relationship between the monitored digital signal level and the analog signal level that is output from both of the XLR connectors on the back panel. The default setting is -20 Dbfs = +8 dBu as shown in Figure 2-21. The range of possible settings is as follows:
 - a. -20 dBFS = +8 dBu
 - b. -20 dBFS = 0 dBu
 - c. -22 dBFS = +4 dBu
 - d. 0 dBFS = +15 dBu
 - e. -16 dBFS = +4 dBu
 - f. -18 dBFS = +4 dBu
 - g. -18 dBFS = 0 dBu
 - h. -20 dBFS = +4 dBu

Touching **Save** will save any changes made, or touching **Cancel** will return you to the **System Options** menu without saving.

Meter Scales

Touching the **Meter Scales** button on the **Unit Settings** Menu displays the **Meter Scales** screen as shown in Figure 2-22. The controls on this screen select the scale standards as well as the ballistics that will be applied to the audio meters.

Figure 2-22: Meter Scales Screen

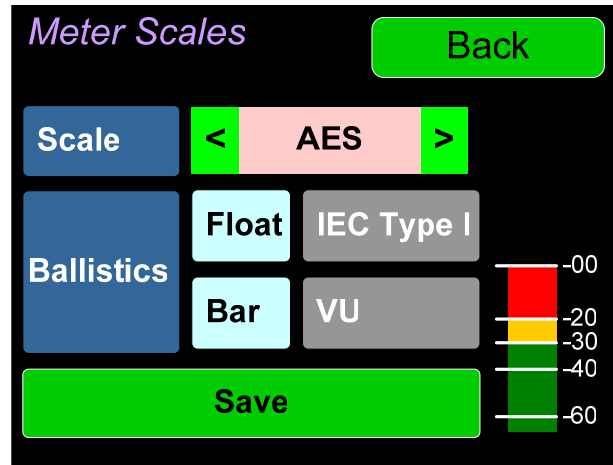

The controls function as follows:

1. **Scale:** This meter scales standard to be used when displaying audio levels. A choice of seven scales is available. Touch the left or right arrows to select the scale. A representation of the chosen scale will be shown at the right. The possible scales that can be selected are shown in Figure 2-23.

Figure 2-23: Meter Scale Selection

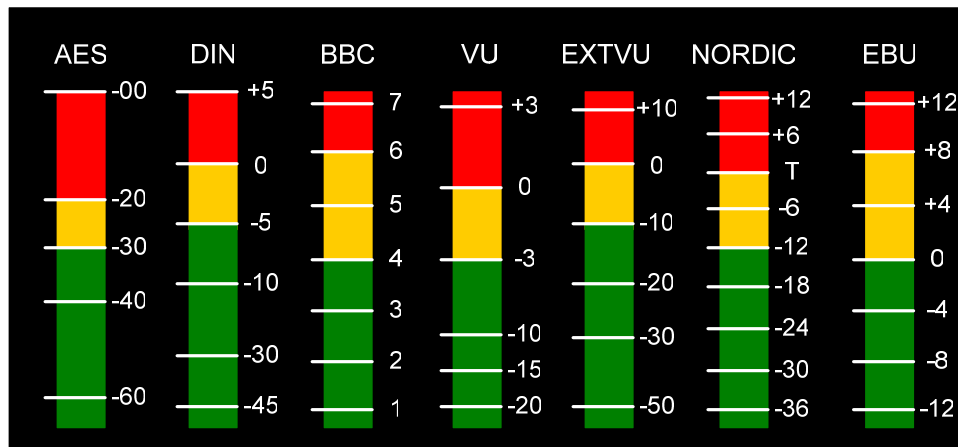

Table 2-4: Meter Limits and References

Scale	Bottom Limit	Top Limit	Default Reference	Default Color Bounds		Default Ballistics	
				Lower	Upper	Float	Bar
AES	-72 dBFS	0.0 dBFS	0 dBFS = 0 dBFS	-30 dBFS	-20 dBFS	IEC Type I	VU
DIN	-53 dBr	+5.5 dBr	-15 dBFS = 0 dBr	-5 dBr	0 dBr	—	IEC Type I
BBC	-13.25 dBr	+13.0 dBr	-18 dBFS = 0 dBr	0 dBr	8 dBr	—	IEC Type I
VU	-45 dBr	+3.5 dBr	-20 dBFS = 0 dBr	-3 dBr	0 dBr	—	VU
EXTVU	-56 dBr	+16.0 dBr	-20 dBFS = 0 dBr	-10 dBr	0 dBr	—	VU
NORDIC	-44 dBr	+12.5 dBr	-18 dBFS = 0 dBr	-10 dBr	0 dBr	—	IEC Type I
EBU	-13.25 dBr	+13.0 dBr	-18 dBFS = 0 dBr	0 dBr	8 dBr	—	IEC Type I

2. **Ballistics:** The Bar and Float ballistics associated with the selected meter scale are displayed. Refer to Table 2-5. Ballistic timings are valid only at 48 kHz.

Table 2-5: Meter Timings

Ballistics	Rise	Fall	
		Level Change	Time
VU	Not Specified		
IEC Type I	5 ms to reach -2 dB of settled reading	-20 dB	1.7 sec.
IEC Type II	10 ms to reach -2 dB of settled reading	-24 dB	2.8 sec.
None	Bar or Floating Segment Not Displayed		

3. **Segment Boundary:** The Boundaries between the Upper and Middle segments (red and yellow) and the Middle and Lower segments (yellow and green) can be varied. Touch the left or right arrows to select the Upper or Middle scale. Rotate the **Channel** knob to adjust the lower boundary of the selected segment in 1 dB steps.

When you have made your choices, touch **Save** to retain them. Touch **Back** to exit this screen.

System Options Menu

Touching System Options in the **Main Menu** proceeds to the **System Options** menu, which is an intermediate menu leading to other screens. This menu is shown in Figure 2-24.

Figure 2-24: System Options Menu

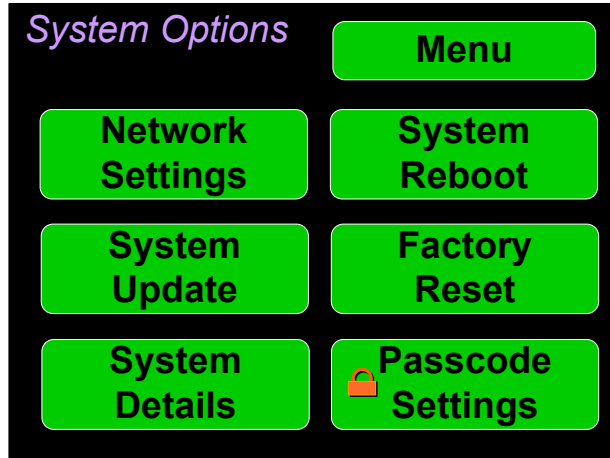

Touch **Menu** to exit this menu.

Network Settings

Touch the **Network Settings** selection on the **System Options** Menu displays the **Network Settings** menu as shown in Figure 2-25. This screen lets you view or change the product IP, the Net Mask, Gateway and DNS. It also lets you switch between a static (fixed) or a dynamic (DHCP) network address.

Figure 2-25: Network Settings Screen

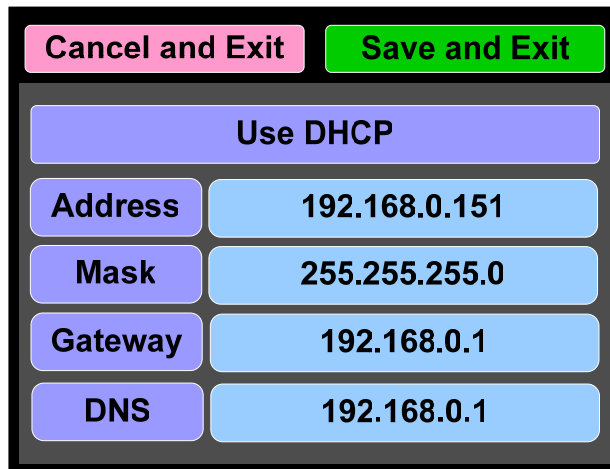

1. To change the IP Address, Net Mask, Gateway, or DNS, tap the item you would like to change. A keypad will appear, as shown in Figure 2-26.

Figure 2-26: Network Configuration: Setting Change

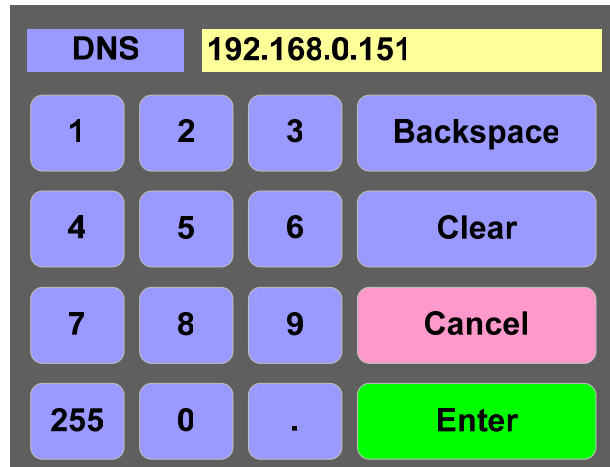

2. Touch the digits to be entered and then touch the **Enter** button. The **Clear** button may be touched to erase any mistyped digits.
3. Now repeat steps 1 and 2 until you have replaced all of the necessary digits.
4. To save the newly entered address, touch the **Enter** button. Touch the **Cancel** button to return to the previous screen without saving any changes.

Important:

There is no confirmation for **Save**, so make sure you want to perform this action before taking it. The system does not need to reboot before it is once again ready for operation.

To change from a static (fixed) to a dynamic (DHCP) network address, touch the **DHCP** button. The screen will change, as shown in Figure 2-27. To change back to a static (fixed) network address, touch the **DHCP** button again. The colors of the buttons will return to the ones depicted in Figure 2-25.

Figure 2-27: Network Settings: DHCP

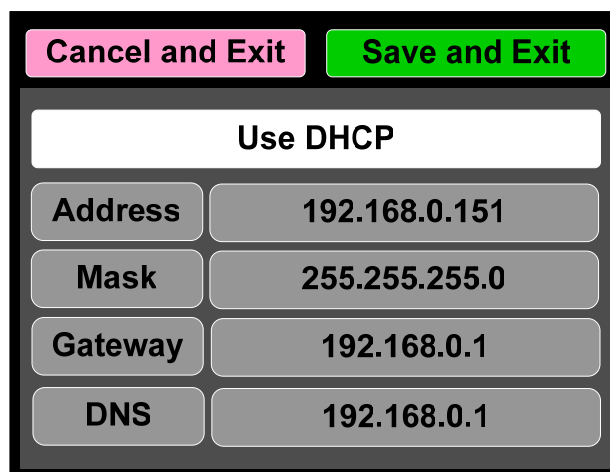

1. To complete the network addressing scheme change, touch the **Save** button. This will save the changes you selected.

2. Touch the **Cancel** button to return to the previous screen without saving any changes.

Important:

There is no confirmation for **Save and Exit**, so make sure you want to perform this action before taking it. The system will not need to reboot before it is once again ready for operation.

System Reboot

Touching the **System Reboot** selection on the **System Options** Menu displays the **System Reboot** screen as shown in Figure 2-28. This function is normally only used upon request from Wohler Technical Service to troubleshoot or correct an issue.

The **System Reboot** function should be used with a bit of forethought. It puts the system out of service for several minutes while it is rebooting.

Figure 2-28: System Reboot

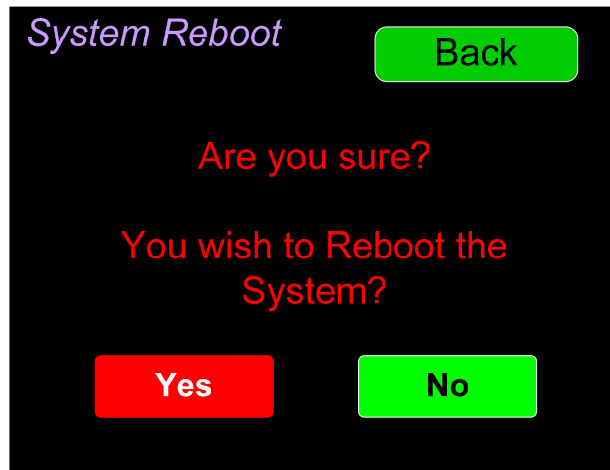

If you have any doubt as to whether you should press **Yes**, press **Back** or **No** instead, and contact Wohler Technical Service for advice. Pressing **Back** or **No** will return you to the **System Options** menu.

System Update

Touching the **System Update** selection in the **System Options** Menu displays **System Update** screen as shown in Figure 2-29, showing the current software version of the product. To update the system software locally from the eAMP1-8M/16M front panel, follow the procedure in the **Local Update from the Front Panel** section of Appendix A.

Figure 2-29: System Update Screen

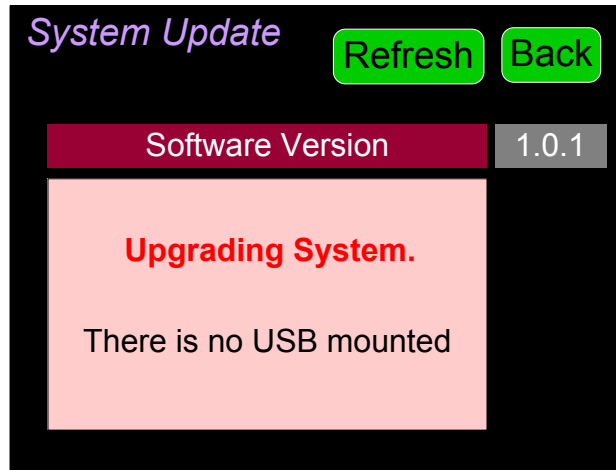

If you have just inserted a flash drive with a valid software upgrade package, press **Refresh** to see that package.

Touch the **Back** button return to the **System Options Menu**.

Factory Reset

Touching the **Factory Reset** selection in the **System Options** menu displays the **Factory Reset** screen as shown in Figure 2-30. Because of the large change this function is about to make to the product, it asks for you for verification that you really want to proceed.

The **Factory Reset** function should be used with caution. It deletes all of the settings you have programmed into the system. It returns the system to the way it was when received new from the factory. After using this function, you will need to use the Wohler Web GUI to reprogram everything from the start.

Figure 2-30: Factory Reset

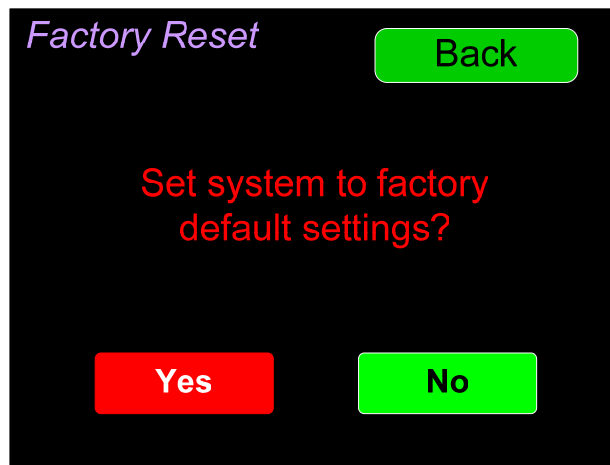

Note: **Factory Reset** will also reset your IP address to the default one. After a Factory Reset, the IP Settings will need to be updated. The default IP address for the unit is determined based upon the Mac address. It is 169.254.1.xx where xx is the last octet of the management Mac address. For example, if the Mac address is b4:ed:54:d0:04:28 then the IP address would be 169.254.1.40 (40 is the decimal equivalent for the last octet of Mac address 28.)

If you have any doubt as to whether you should press **Yes**, press **Back** or **No** instead, and contact Wohler Technical Service for advice. Pressing **Back** or **No** will return you to the **System Options** menu.

System Information

Touching the **System Details** selection in the **System Options** menu displays the **System Details** screen as shown in Figure 2-31. This screen lets you view the product Serial Number, Software Version, and various other information.

Figure 2-31: System Details Screen

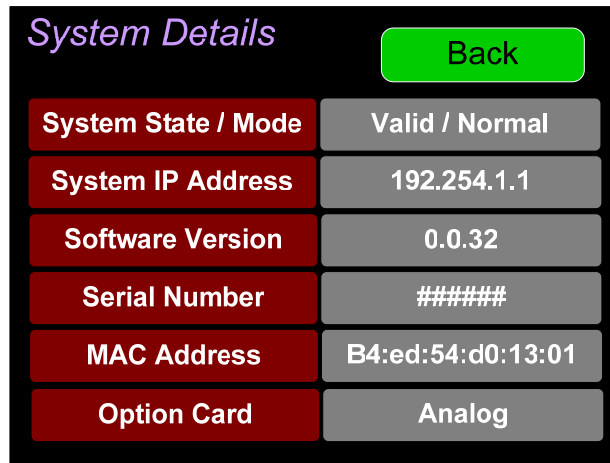

The screenshot shows a mobile application interface for 'System Details'. At the top left, the title 'System Details' is displayed in a light purple font. To the right of the title is a green button labeled 'Back'. Below the title and button is a table with six rows. Each row has a red header cell on the left and a grey data cell on the right. The rows are: 'System State / Mode' with value 'Valid / Normal'; 'System IP Address' with value '192.254.1.1'; 'Software Version' with value '0.0.32'; 'Serial Number' with value '#####'; 'MAC Address' with value 'B4:ed:54:d0:13:01'; and 'Option Card' with value 'Analog'.

<i>System Details</i>	
System State / Mode	Valid / Normal
System IP Address	192.254.1.1
Software Version	0.0.32
Serial Number	#####
MAC Address	B4:ed:54:d0:13:01
Option Card	Analog

The information shown on this screen is read only and cannot be changed. Touch **Back** to return to the **System Options** Menu.

Passcode Settings

This feature is available if the OPTe Package is purchased. To prevent accidental or unauthorized changing of critical settings in some of the menus, it is possible to block or restrict access to various menus. The Wohler Web GUI can be used to limit access to the menus of your choice. Refer to Chapter 4, the **Front Panel Configuration** tab of **System Preferences**.

The eAMP1-8M/16M contains a **Passcode Settings** screen. Access to this screen is always protected by a unique Passcode, which you can set. Note that the protection of the **Passcode Settings** selection is indicated by an orange lock icon:  The **Passcode Settings** button on the **System Options** screen contains this icon, as shown in Figure 2-32. The factory default Passcode is 0-0-0-0.

Figure 2-32: System Options – Passcode Settings Lock



Touching the **Passcode Settings** selection in the **System Options** menu proceeds to the **Passcode Entry** screen as shown in the left image of Figure 2-33.

Figure 2-33: Passcode Entry Screen

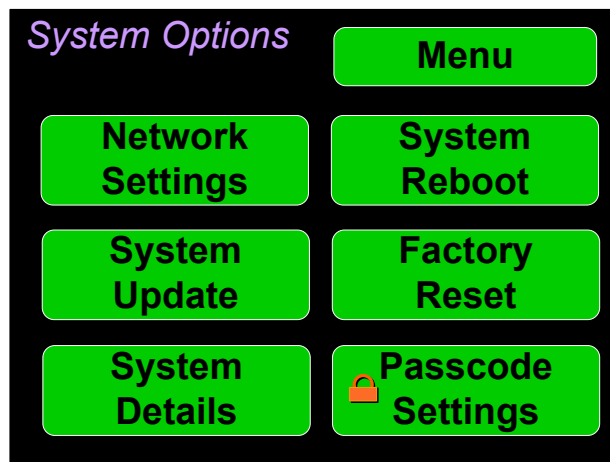
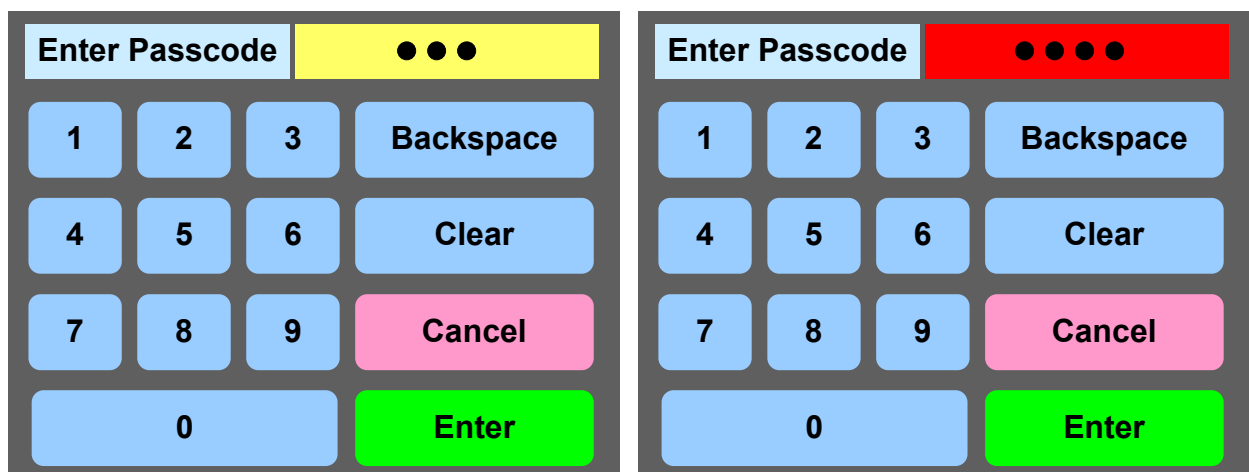

Enter the Passcode on the keypad and touch **Enter**. The numbers will display as bullets in the field. If you enter the wrong Passcode, the entry field will turn red, as

shown on the right image of Figure 2-33. Press **Clear** and try again.

When you have successfully entered the Passcode, the Passcode Settings screen will appear, as shown in Figure 2-34.

Figure 2-34: Passcode Settings Screen

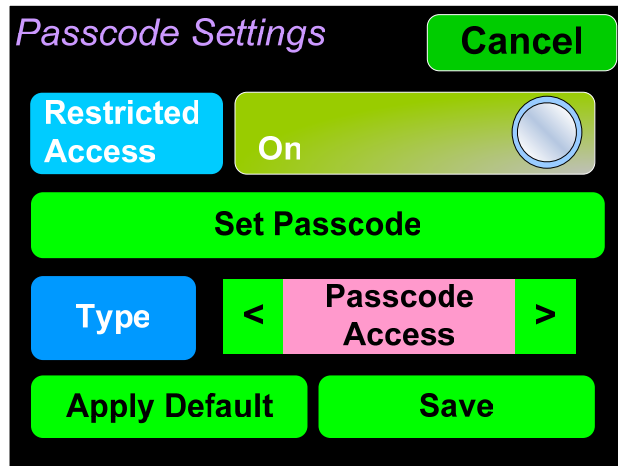

The functions on this screen are as follows:

Restricted Access: This switch will turn ON or OFF protection or blocking of any menus, except for the Passcode Settings menu, which is always Passcode protected.

Set Passcode: Touching this button proceeds to a keypad which allows you to enter a new Passcode. The screen shown in Figure 2-35 will appear. The Passcode can be any 4-digit number. Touch **Enter** to save the new Passcode or touch **Cancel** to keep the previous Passcode. Be sure to save the Passcode in a safe place for future reference.

Figure 2-35: Set Passcode Screen

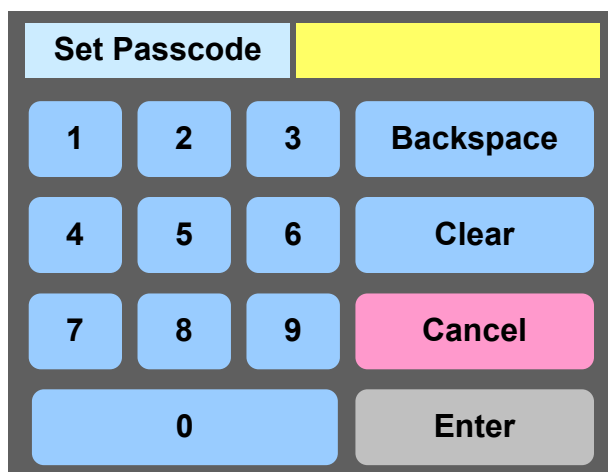

Type: Select the type of disabled button appearance using the **Type** button. The choices are:

Passcode Access: The Passcode protected function buttons include a small orange padlock icon within the buttons. This is shown in the left image of Figure 2-36. Touching these buttons will cause a Passcode entry screen to

appear, as shown in Figure 2-35. The correct Passcode must be entered to proceed.

No Access: If the function buttons are protected by No Access, the buttons are grayed out and non-functional, as shown in the right image of Figure 2-36. These buttons cannot be accessed at all unless the restricted protection is removed by switching OFF the **Restricted Access** setting in this menu.

Figure 2-36: Examples of Menu Protection

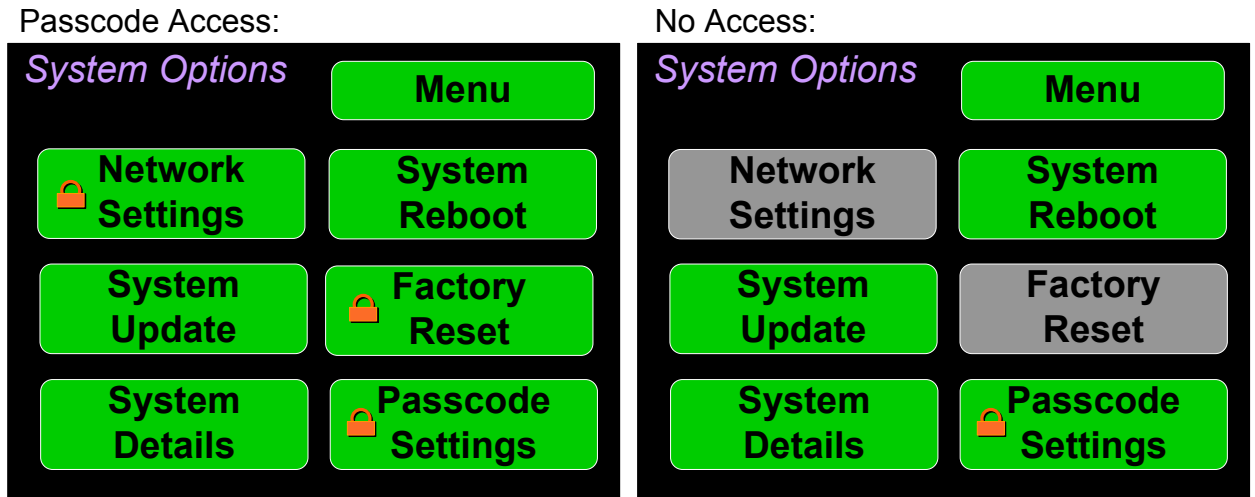

Apply Default: Touching this button returns the settings in this screen to the factory default values. The Passcode becomes 0-0-0-0.

Save: Touching this button saves the settings made in this screen and returns to the **System Options** screen.

Forgotten Passcode

Although the Passcode should be remembered or securely noted somewhere, it can happen that it is forgotten. This can be remedied by performing a Factory Reset from the Wohler Web GUI. Unfortunately, this will also erase all of the menu settings. You may also contact Wohler Technical Service for help.

CHAPTER 3: Technical Info

Table 3-1: eAMP1-8M/16M Specifications

Specification	Values/Domains
Power Requirements	100 VAC to 240 VAC \pm 10%, 50/60Hz
Power Consumption	19 Watts
Dimensions (H x W x D)	1.75" x 19" x 5.5" (44mm x 483mm x 140mm), standard 19" rack mounting
Shipping/Net Weight	5.8 lbs. (2.6 kg) / 3.3 lbs. (1.5 kg)
Supplied Accessories	AC Power Cord
Display Type	7" (178mm) Capacitive Touchscreen LCD
Screen Resolution	1242H x 280V
Viewing Angle	160 (H) x 160 (V)
Level Meters	Simultaneous Average & PPM
Level Meter Scale	Choice of AES, BBC, DIN, EBU, EXTVU, NORDIC, or VU
Sample Rate	48kHz
Upgrades	Via USB or GUI web interface
Analog Output – Stereo	XLR-3 Male, balanced +28 dBU max
Analog Output Frequency Response	40 Hz to 20 kHz (\pm 1dB)
Analog Output Distortion	<0.02% THD+N
Analog Output Dynamic Range	> 100 dB
Analog Output Reference Level	-20 dBFS = +4 \pm 1.0 dBU
Internal Speakers – Stereo	70mm Full Range
Peak Acoustic Output	90 dB SPL (@ 2 feet)
Hum and Noise	Better than -68 dB below full output
Power Output	5 Watts RMS, 12 Watts peak (each side)
Acoustic Frequency Response	150 Hz to 16 kHz (\pm 5 dB)
Headphone Out – Stereo	40 Hz to 20 kHz (\pm 1 dB)
Headphone Load	8 Ω to 150 Ω

Table 3–2: eAMP1-8M Model Specifications

Specification	Values/Domains
Audio Channels	8 Max
SDI Inputs / Outputs	Two 3G/HD/SD SDI Inputs and Outputs, along with a Selected SDI Output
De-Multiplexing	8 channels from 16-channel 3G/HD/SD-SDI
SDI Input Termination	75Ω unbalanced
Cable Length (max)	COAX (such as Belden 1694A): > 150 m
Cable Length (max)	COAX (such as Belden 1694A): > 150 m

Table 3–3: eAMP1-16M Model Specifications

Specification	Values/Domains
Audio Channels	16 Max
SDI Inputs / Outputs	Two 3G/HD/SD SDI Inputs and Outputs, along with a Selected SDI Output
De-Multiplexing	16 channels from 16-channel 3G/HD/SD-SDI
SDI Input Termination	75Ω unbalanced
Cable Length (max)	COAX (such as Belden 1694A): > 150 m
Cable Length (max)	COAX (such as Belden 1694A): > 150 m

Table 3–9: eAMP1-8M/16M Options

Option	Part #	Description
OPTe Package	829186	Adds Loudness monitoring, Presets, and Web metering/monitoring/configuration to the other product features.
OPT-DOLBY (Future)	829174	Allows decoding and monitoring of Dolby® D, DD+ & E. Includes Wohler Zoom & metadata. *This option requires the OPTe Package

Figure 3-1: eAMP1-8M Block Diagram

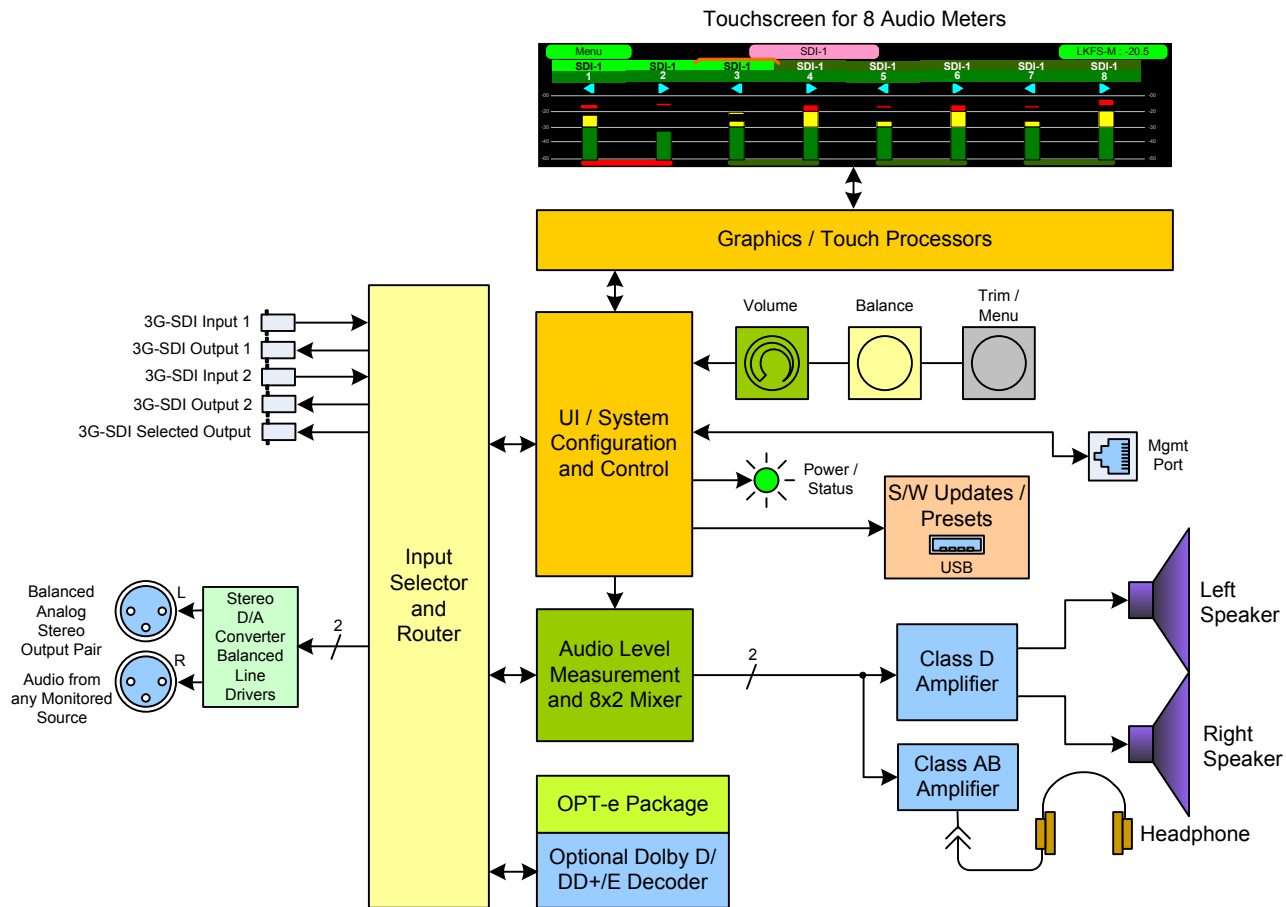
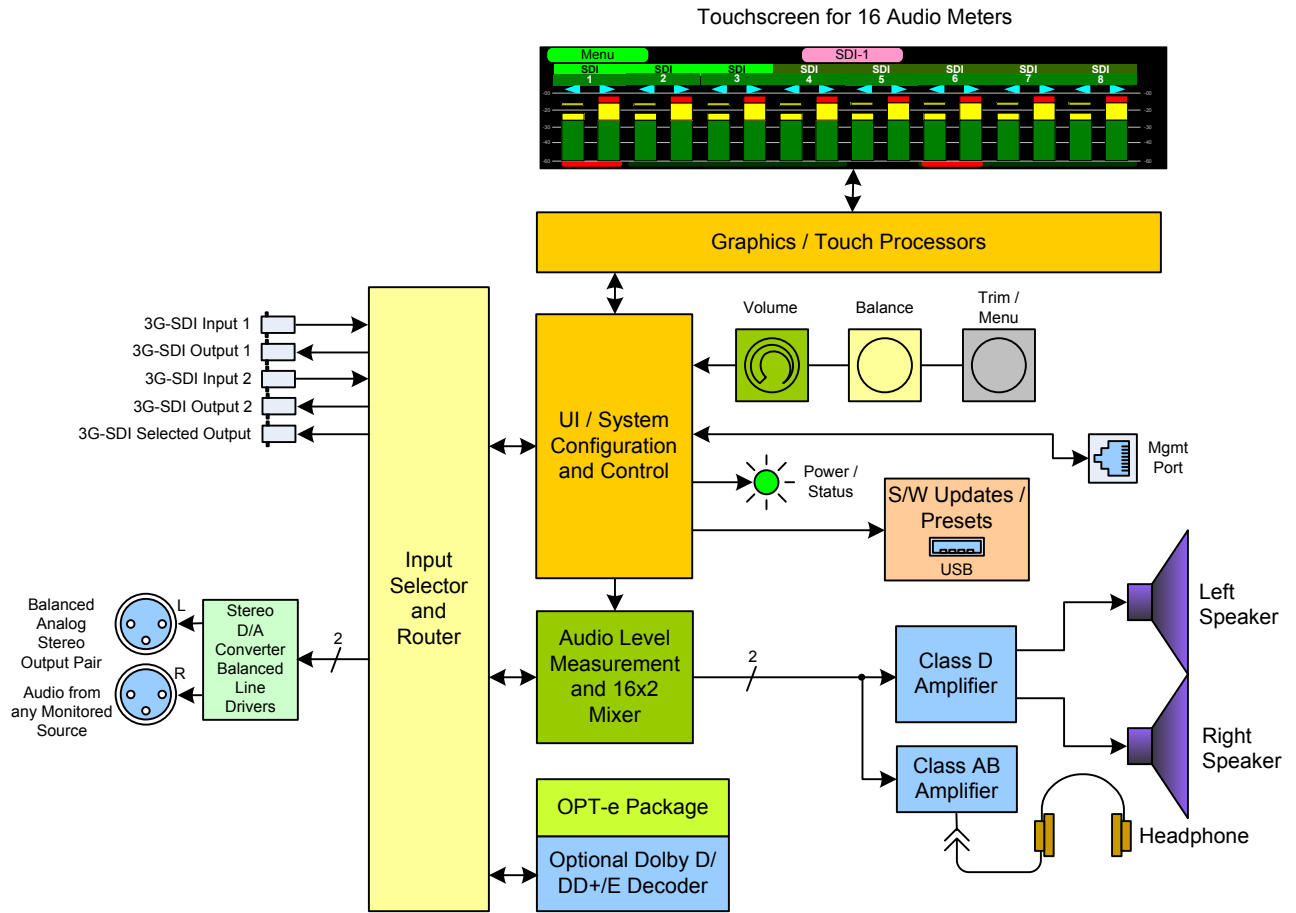

Figure 3-2: eAMP1-16M Block Diagram



CHAPTER 4: The eAMP1-8M/16M Web GUI

The self-contained eAMP1-8M/16M Web GUI allows you to customize the configuration of the eAMP1-8M/16M to suit your needs. This optional package also includes the powerful Loudness Measurement and Preset features described throughout this chapter. If the default configuration suits your needs and you prefer to use it that way, then you do not need to use the eAMP1-8M/16M Web GUI.

The eAMP1-8M/16M Web GUI also allows you to have a remote view of the Meter Screen. Refer to the Audio Meters section in this chapter.

Web Browser / Control Device

Any web browser application running on any networked device such as desktop or laptop computer, tablet or smart phone can be used with the eAMP1-8M/16M Web GUI.

Tablets with no network connector need to be linked to a copper LAN through a Wi-Fi adapter.

Although they can be used, smart phones are not recommended because their smaller screen size would require more scrolling, making operation challenging.

The Chrome[®] web browser is recommended for speed and compatibility.

First Time IP Assignments

The eAMP1-8M/16M can operate with a static (fixed) or dynamic (DHCP) IPv4 address. The default address will be **169.254.1.x** where x depends upon the MAC address of the unit, when received from the factory or when switched from DHCP to static addressing mode. There two basic types of connections that may be used to connect the eAMP1-8M/16M to a web browser, a **Peer-to-Peer Connection** or a **Network Connection**.

Peer-to-Peer Connection

The most straightforward way to connect the eAMP1-8M/16M to a web browser, free of possible network conflicts, is to establish a static peer-to-peer connection between the setup computer and the eAMP1-8M/16M. A 10/100/1000 MHz Ethernet switch may be used in between, but is not required.

Figure 4-1 shows an example of suitable address settings for the host computer in a Windows control panel. For Peer-to-Peer the IP address of windows should be in 169.254.1.x domain.

Figure 4–1: Host IP Settings

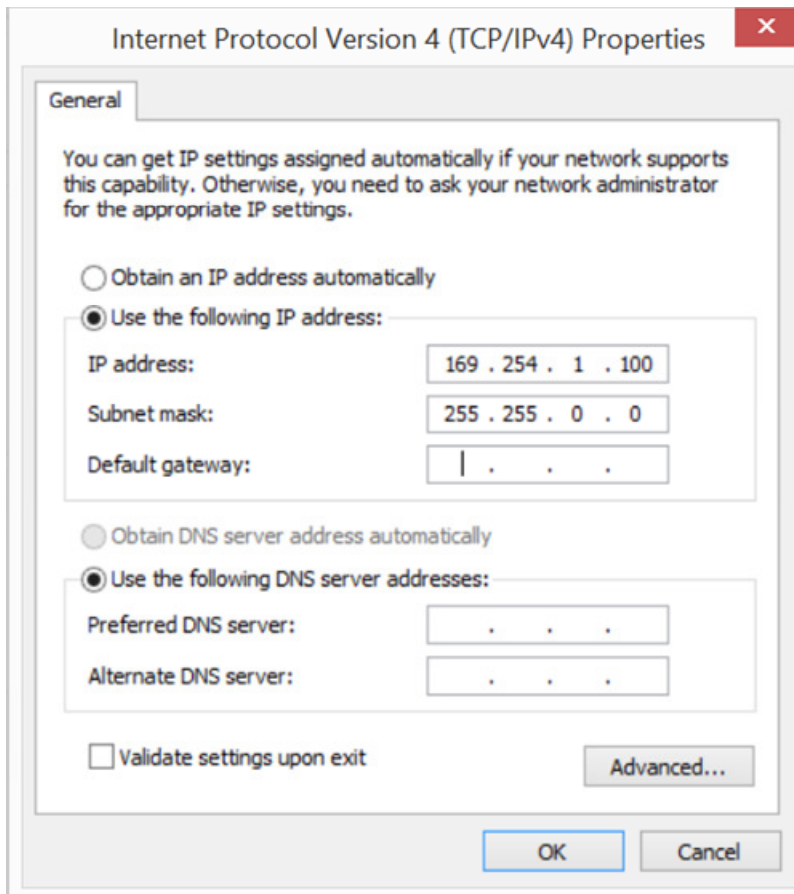

Close the control panel and reboot the host computer after making an IP address change to be sure the change takes effect. **Either reconnect to the installed network or continue with this direct connection to access the eAMP1-8M/16M Web GUI.**

Network Connection

When connected to a network, the eAMP1-8M/16M address will need to be changed to another address in order to be compatible with the address assignments for that particular network. Immediately after the host setup is complete, change the eAMP1-8M/16M's address. Make the corresponding address, mask and gateway changes in the eAMP1-8M/16M **Network Setup** page. Refer to the **Network Setup** section which follows.

Otherwise set the eAMP1-8M/16M to DHCP address mode by checking the box for 'Use DHCP?' in Network Setup and have your IT administrator assign rights and settings for operation on the network. Allow enough time for your network's DHCP server to recognize a new network device and assign an address after booting.

The eAMP1-8M/16M uses link local addressing for its internal network, so no accommodation for this need be made in the network.

Network Setup

Make network **IP Address** changes for the local eAMP1-8M/16M **Management (MGMT) Port** here.

Figure 4–2: Set IP Addresses

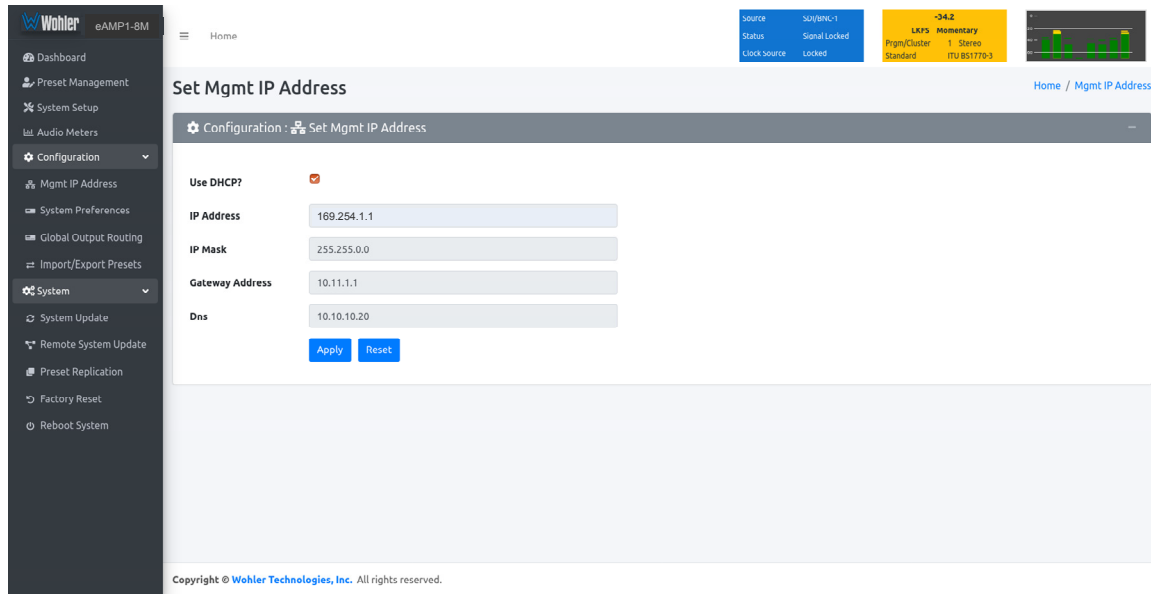

The procedure for changing the IP Address information is as follows:

1. **Use DHCP?** Check this box if your network has a DHCP server and you want to use dynamic addressing. Otherwise, you must enter static IP address entries in the four fields which follow.
2. **IP Address:** Enter the network address. Leading zeroes are not required.
3. **IP Mask:** This should usually be 255.255.255.0 unless your network can work across multiple subnets.
4. **Gateway Address:** This should usually be the same domain and subnet address numbers as the IP Address, but with the last octet being .1.
5. **DNS-nameserver:** A default value is shown for reference only. DNS is not normally required for basic static IP network configurations to work. Your IT administrator will specify a value to work with mixed static/dynamic network setups.
6. **Apply:** When you have made all of the necessary entries, press **Apply** to apply the changes.
7. **Reset:** If you should start to make changes and then change your mind about making them, press **Reset** to return the settings back to where they were.

Dashboard

Throughout the Web GUI, pages are a click or two away using the list of selections on the left side. The **Dashboard** page shows all of the available Preset configurations at a glance. If the optional OPTe Package is installed, the eAMP1-8M/16M allows you to assign Presets to particular groups. In Figure 4-3, two groups, Operator-1 and Operator-2 are shown.

Figure 4-3: Dashboard Preset Overview

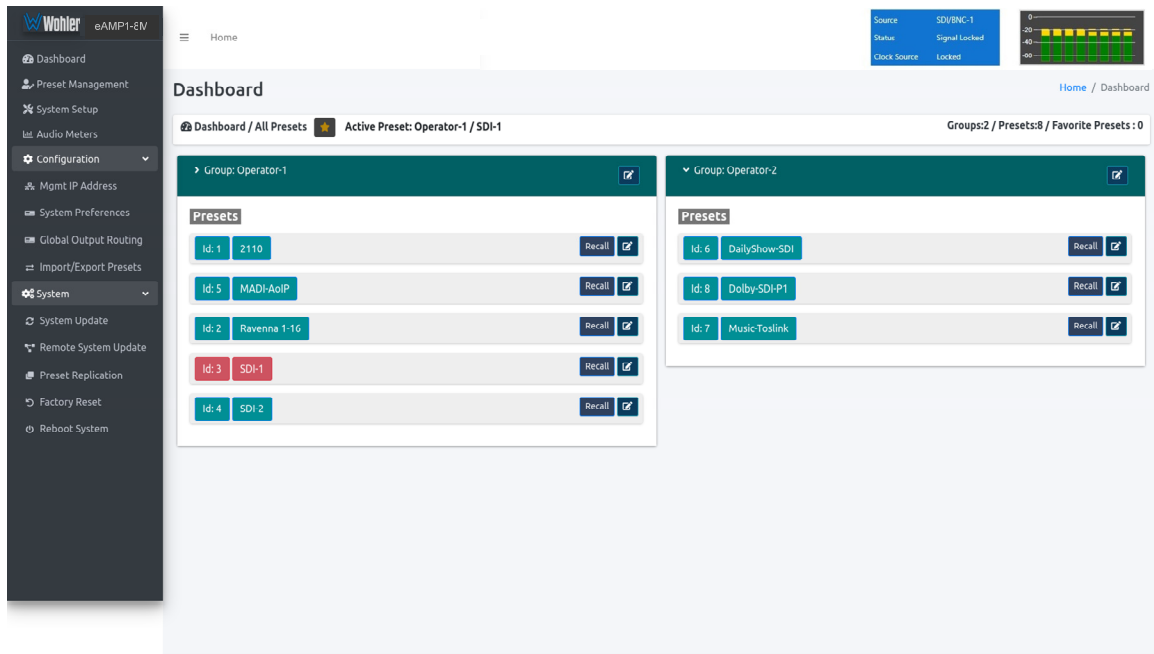

To view all of the Presets within a group, click on that group.

In Figure 4-4, it can be seen that there are five Presets in the Operator-1 group and no Presets in the Operator-2 group. The currently selected active Preset for local operation is shown in red. In Figure 4-4, this is the Preset named SDI-1.

Figure 4-4: Dashboard Preset Recall / Edit

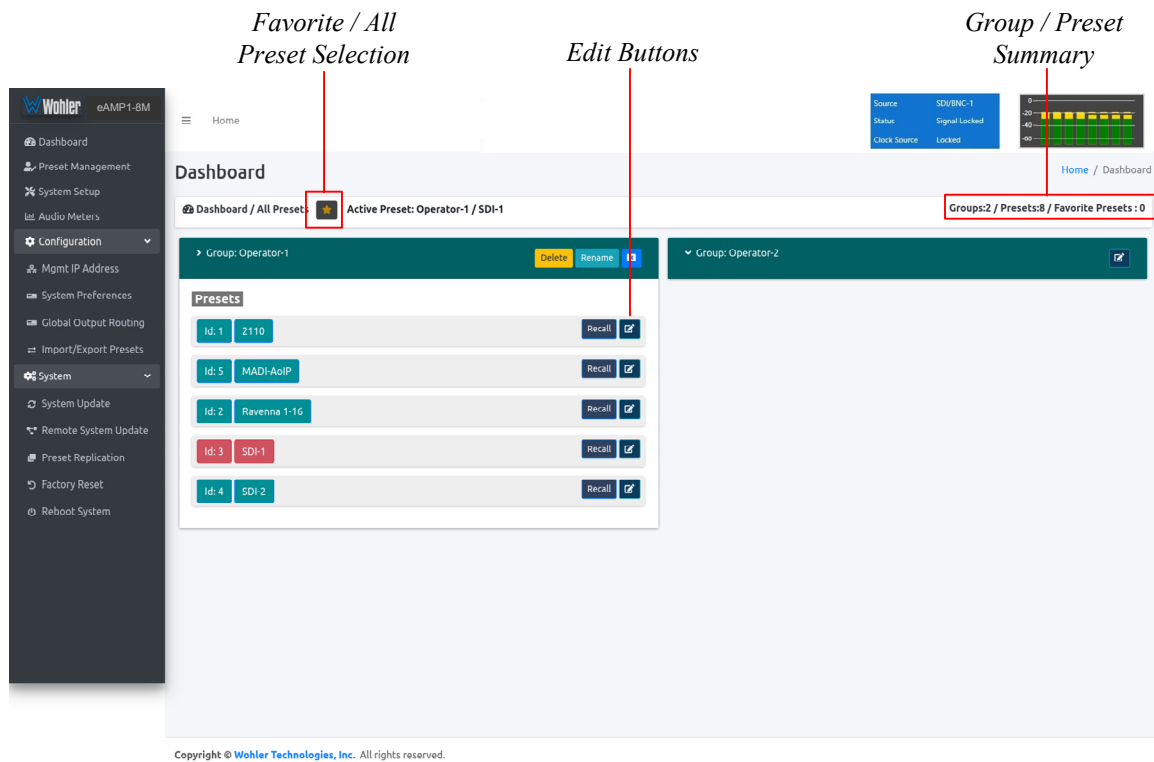

A Group / Preset Summary is shown in the upper right of the screen. This enables you to see the total number of Groups, Presets and Favorite Presets in the eAMP1-8M/16M.

Use the  button, as shown in Figure 4-4, to toggle between Favorite Presets or All Presets.

Click the **Recall** button to recall a Preset. To Edit a Preset, click the **Edit** icon, as shown in Figure 4-4, to the right of the associated **Recall** button.

After clicking the **Preset Edit** button, the screen shown in Figure 4-5 will appear. Clicking a **Group Edit** button will cause the screen in Figure 4-6 to appear.

Figure 4–5: Dashboard Preset Edit

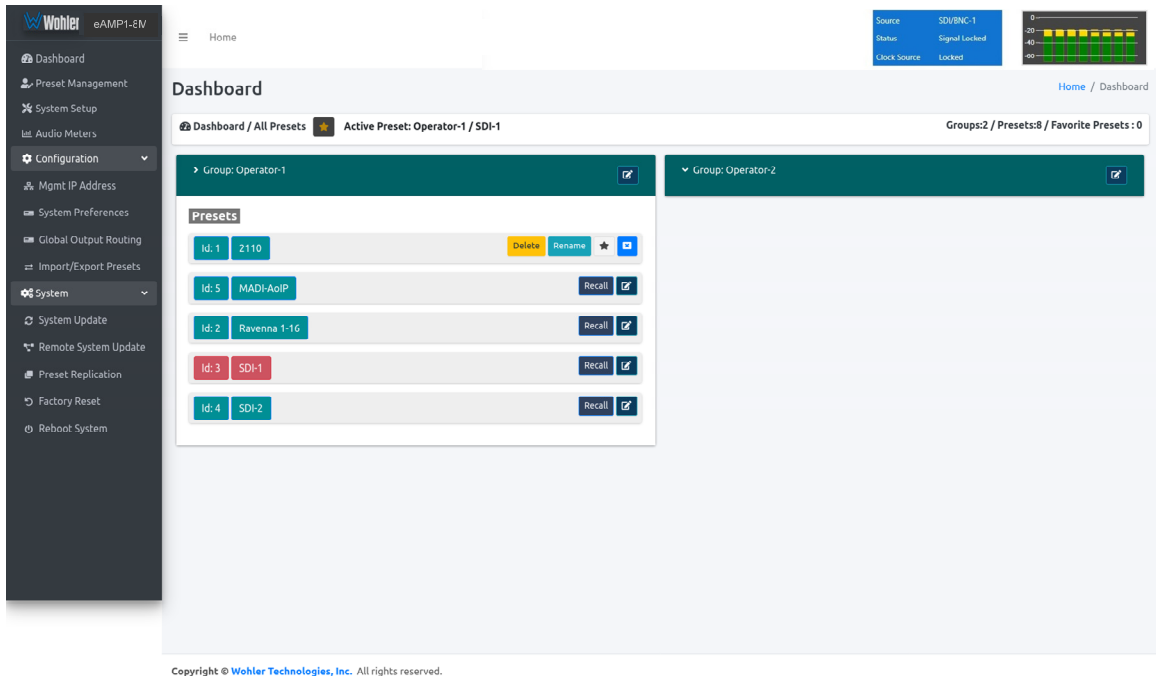

The Edit options for a Preset are:

1. Delete: Remove the Preset from the system. **Do Not delete the currently active Preset.**
2. Rename: Rename the Preset, but keep all of its other characteristics.
3. Make Favorite: Make this Preset a favorite. This can be done for frequently used Presets.

Figure 4–6: Dashboard Group Edit

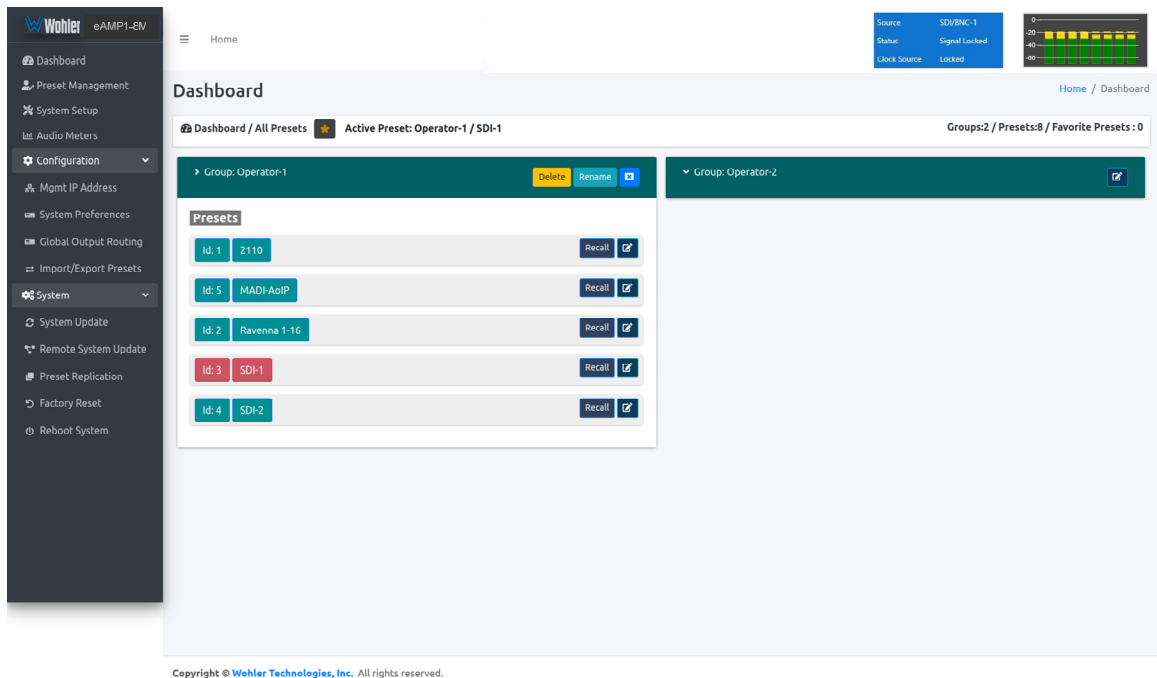

The Edit options for a Group are as follows:

1. Delete: Delete the Group and all of the Presets it contains.
2. Rename: Rename the Group, but keep all of its other characteristics.

Audio Meters

Click on **Audio Meters** to remotely display the audio meters of the eAMP1-8M/16M. This display is shown in Figure 4-7. Also displayed is the name of the source that the meters are displaying. In Figure 4-7, this is SDI/BNC-1.

Figure 4-7: Audio Meters Display

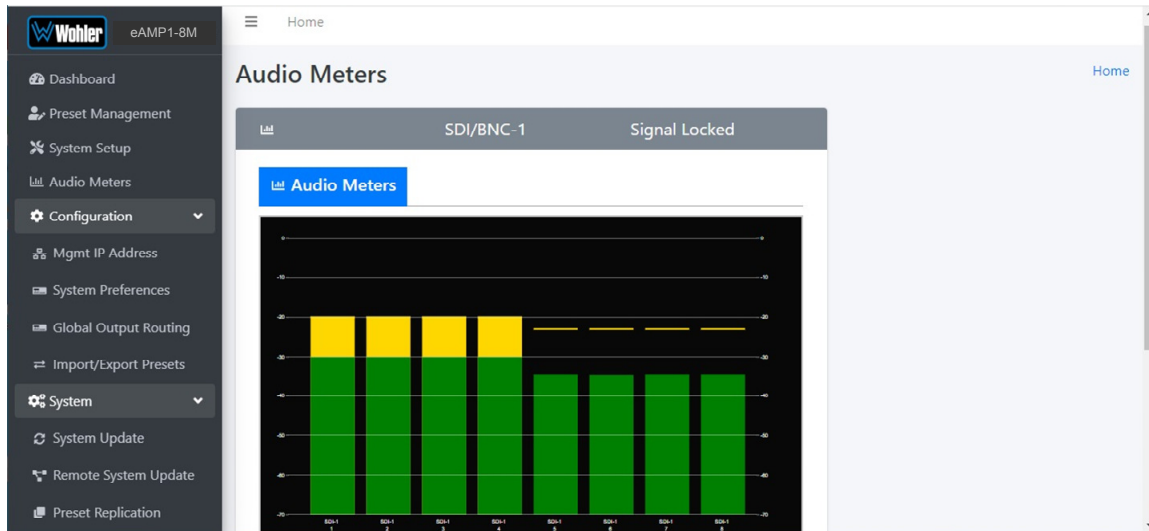

System Preferences

Click on **System Preferences** to find the System Audio Clock Reference, Loudness Configuration, Phase Indicator Configuration, and Front Panel Configuration tabs. These are as shown in Figures 4-8, 4-9, 4-10, and 4-11.

System Audio Clock Reference

This feature is available if the OPTe Package is purchased. The System Audio Clock Reference setting provides a way to set the global clock source for the unit. This setting will be used whenever a source is selected using the **Source Select Menu**. If the System Audio Clock Reference is set to **None**, then the currently selected source acts as the Clock Reference. This tab is shown in Figure 4-8.

This System Audio Clock Reference setting can be overridden by the optional System Clock Reference setting in the Preset Management menu when the Preset is chosen.

Figure 4-8: System Audio Clock Reference Tab

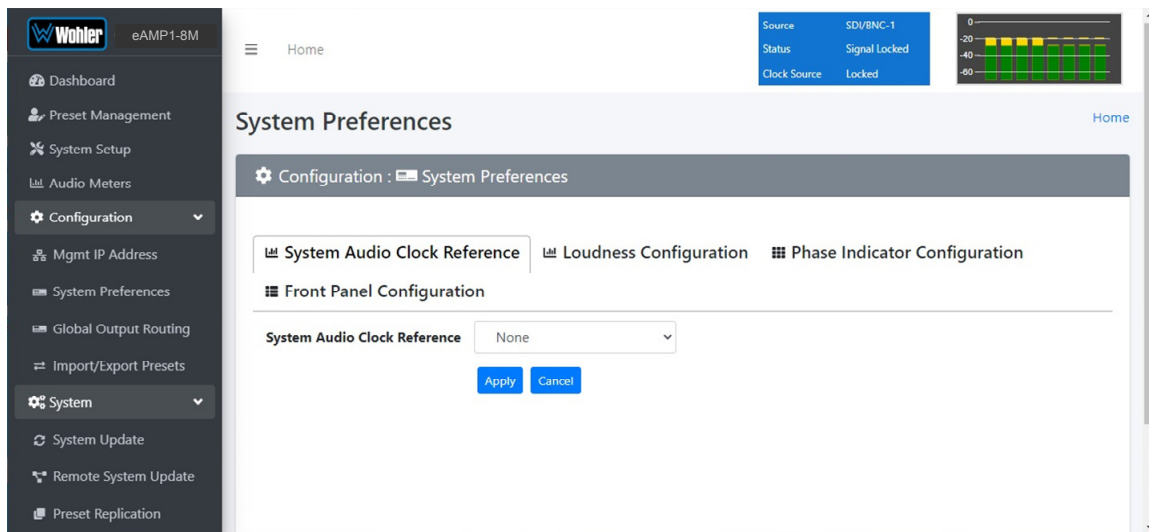

Loudness Configuration Tab

This feature is available if the OPTe Package is purchased. The Loudness Configuration tab allows you to make settings which will determine how Loudness is to be calculated on the Loudness Meter. This tab is shown in Figure 4-9.

Figure 4-9: Loudness Configuration Tab

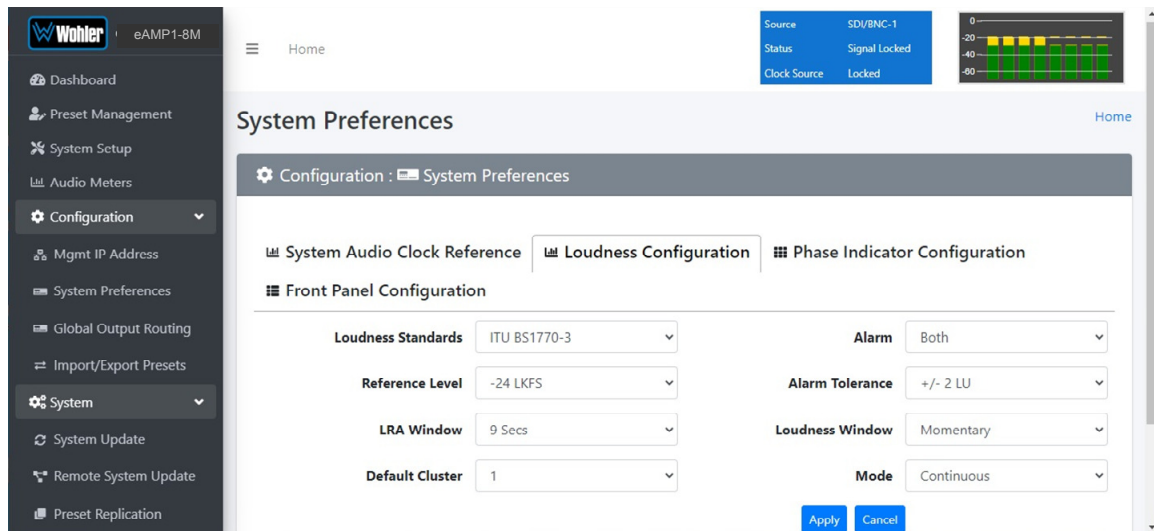

The following settings can be made on this tab:

1. **Loudness Standard:** This is the loudness standard by which the loudness calculation is made.
2. **Reference Level:** This is the set point in the loudness measurement about which the determination is made as to whether an alarm should be displayed.
3. **LRA Window:** This is a moving window of time over which the loudness measurement is made.
4. **Default Cluster:** When a Metering Screen is entered, this is the number of the cluster that will initially be monitored for Loudness.
5. **Alarm:**
 - a. **Over:** The Alarm indication will only appear when Loudness has exceeded the **Reference Level** by the **Tolerance** amount.
 - b. **Under:** The Alarm indication will only appear when Loudness is below the **Reference Level** by the **Tolerance** amount.
 - c. **Both:** The Alarm indication will only appear when Loudness has exceeded or is below the **Reference Level** by the **Tolerance** amount.
 - d. **Off:** The Alarm indication will not appear.
6. **Alarm Tolerance:** This is the range over which a normal loudness indication is given. Above or below this range will result in color changes in the graph.
7. **Loudness Window:** This may be set to **Momentary**, **Short**, or one of 22 values, ranging from one second to two hours.

8. Monitoring Mode:

- a. **Manual:** Touch the Manual button to enable Manual Mode. This allows you to measure the loudness of a specific program or segment of a program, such as a commercial. In this mode, the **Start** and **Stop** button on the Loudness Meter screen can be manually used to begin and end a loudness measurement interval. The reading for that interval is then held on the Loudness Meter.
- b. **Continuous:** Touch the **Continuous** button to enable Continuous Mode. In this mode, loudness readings are continually made. The **Stop** button on the Loudness Meter screen is not active.

Note: Further and more detailed descriptions of all of the above Loudness terms may be found in the ITU-R BS.1770-3 loudness standard.

When you have finished making the settings click **Apply** to save them or click **Cancel** to discard them.

Phase Indicator Configuration Tab

The Phase Indicator Configuration tab is as shown in Figure 4-10. It allows you to select which channel pairs will receive a phase meter on the **Metering Screen**. Generally, it is useful to monitor the relative phase of stereo pairs. However, sometimes each channel of a pair is unrelated to each other. This can be because the channels are used to convey two independent monophonic signals or that one channel may be a Center channel and the other may be a Low Frequency Effects channel. In these instances, the Phase Indicator would almost always indicate an out of phase condition. Because this would be a needless distraction to the operator, switches are provided on this tab to individually turn phase monitoring for each channel pair on or off. **Select All** and **Reset All** buttons are also provided.

Figure 4-10: Phase Indicator Configuration Tab

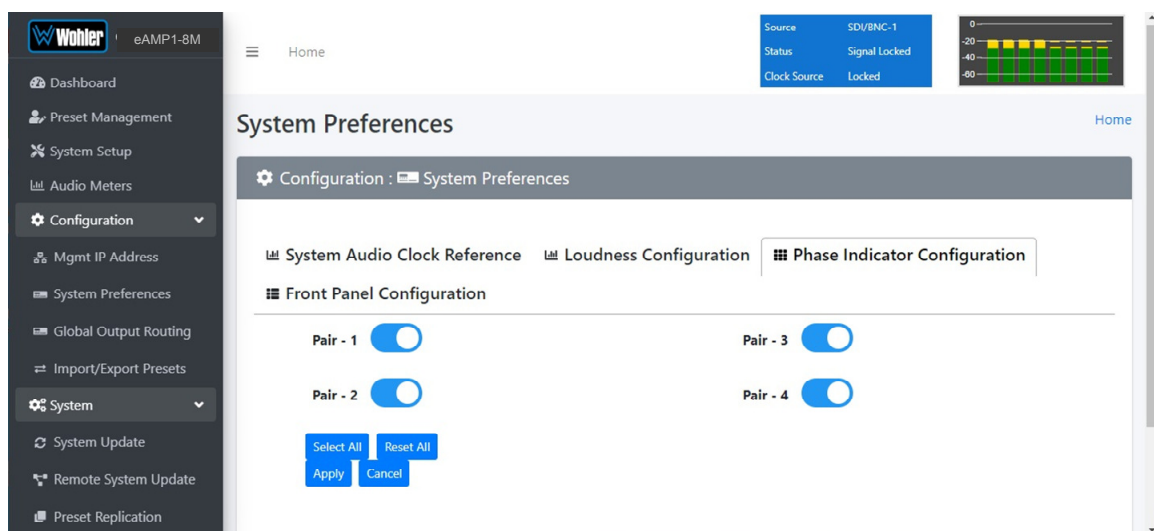

When you have finished making the settings click **Apply** to save them or click **Cancel** to discard them.

Front Panel Configuration Tab

This tab and its associated Passcode feature is available if the OPTe Package is purchased. To prevent accidental or unauthorized changing of critical settings in the local product menus, it is possible to restrict access. The Front Panel Configuration Tab entry screen is shown in Figure 4-11. This provides an entryway to the Front Panel Configuration Tab shown in Figure 4-13. To proceed, you must enter the correct Passcode. If no Passcode has been set, the default Passcode is 0-0-0-0.

Figure 4-11: Front Panel Configuration Tab – Passcode Entry

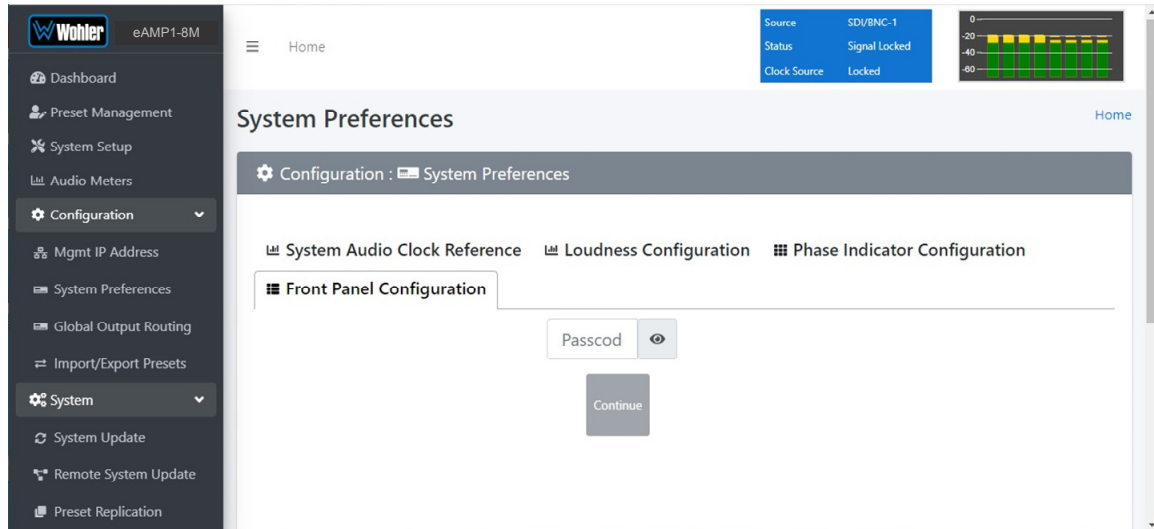

If an incorrect Passcode is entered, the screen shown in Figure 4-12 appears. Click the **Continue** button to try again. If you have forgotten the Passcode, this can be remedied by performing a Factory Reset. Unfortunately, this will also erase all of the menu settings. You may also contact Wohler Technical Service for help.

Figure 4-12: Unrecognized Passcode

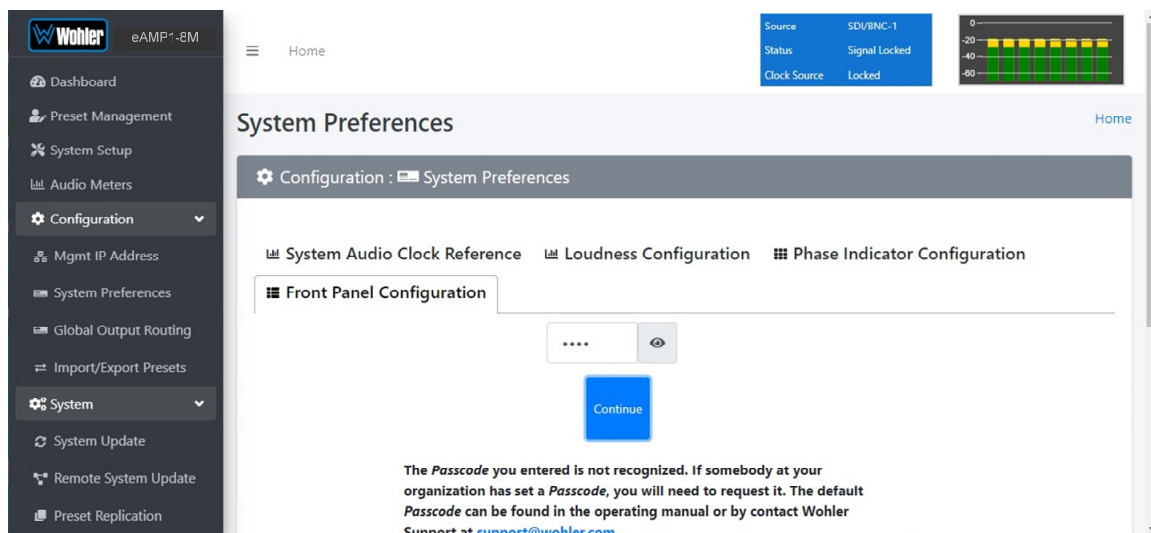

When you have successfully entered the Passcode, the Passcode Settings screen will appear, as shown in Figure 4-13.

Figure 4-13: Front Panel Configuration Tab

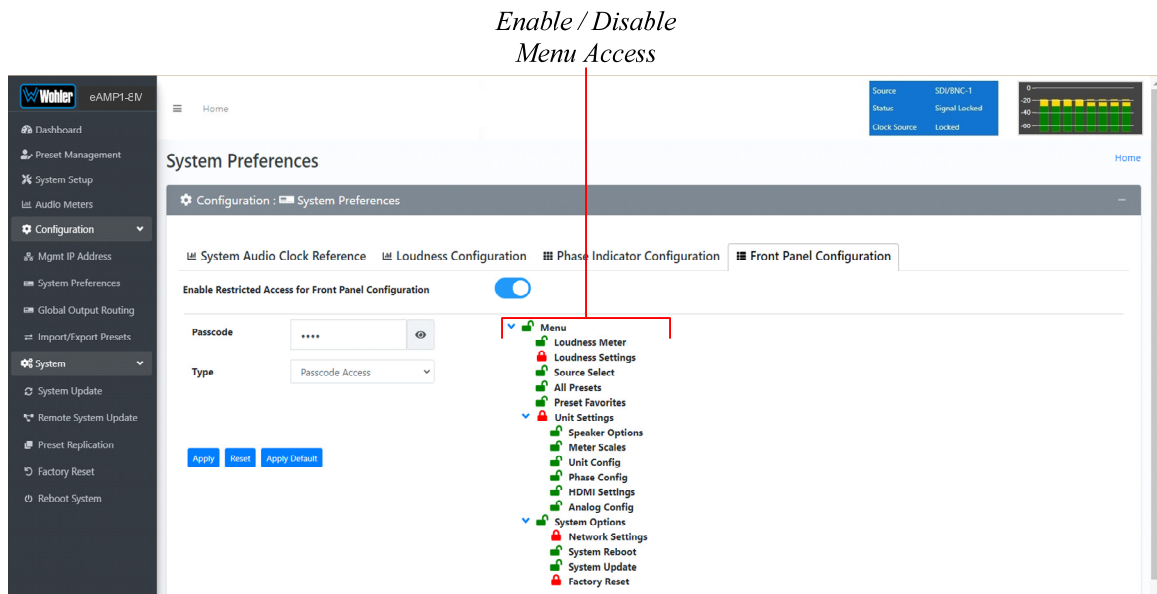

The functions on this screen are as follows:

Enable Restricted Access for Front Panel Configuration: This switch will turn ON or OFF protection or blocking of any local product menus, except for the Passcode Settings menu, which is always Passcode protected.

Passcode: You may enter a new Passcode in this field. The Passcode can be any 4-digit number. Be sure to save the Passcode in a safe place for future reference.

Type: Select the type of disabled button appearance on the local product menus using the **Type** button. The choices are:

Passcode Access: The Passcode protected function buttons include a small orange padlock icon within the buttons. This is shown in the left image of Figure 4-14. These buttons can only be accessed using the correct Passcode.

No Access: If the function buttons are protected by No Access, the buttons are grayed out and non-functional, as shown in the right side of Figure 4-14. These buttons cannot be accessed.

Apply Default: Clicking this button returns the settings in this screen to the factory default values. The Passcode becomes 0-0-0-0.

Reset: Clicking this button undoes any settings you have made on this tab.

Enable / Disable Menu Access: This section provides a nested chart of the local menus that exist in the product. You may set which menus are affected by restrictions. Click any menu shown to change it between affected (red icon) and unaffected (green icon).

Apply: When you have completed the desired settings in this tab, click **Apply** to put them into effect.

Figure 4-14: Examples of Local Menu Protection

Passcode Access:

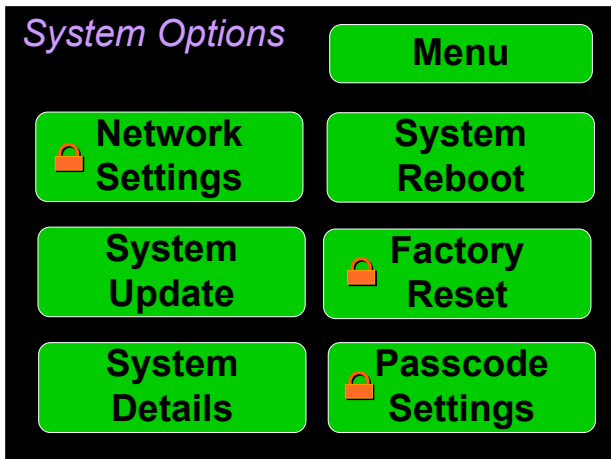

No Access:

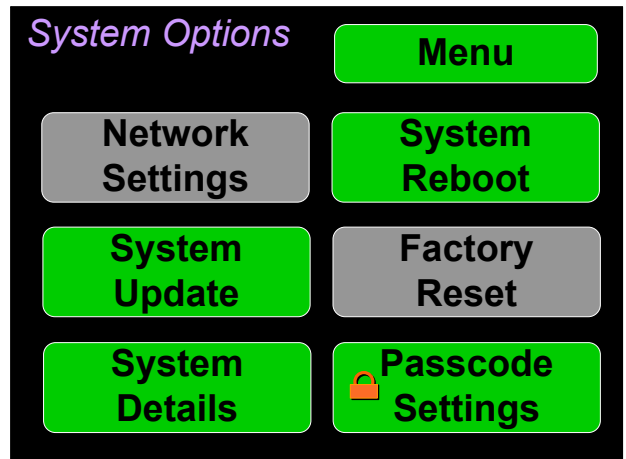

Preset Management

This feature is available if the OPTe Package is purchased. Presets are monitoring configurations that can be composed of channels from multiple sources and displayed on the meters in any order. Presets should be set up to allow operators to quickly shift between setups for monitoring. The **Preset Management** screen contains selections of all of the details for a Preset, and is largely arranged in a matrix format connecting input channels to monitoring channels. The screen is shown in Figure 4-15.

Figure 4–15: Configure Presets

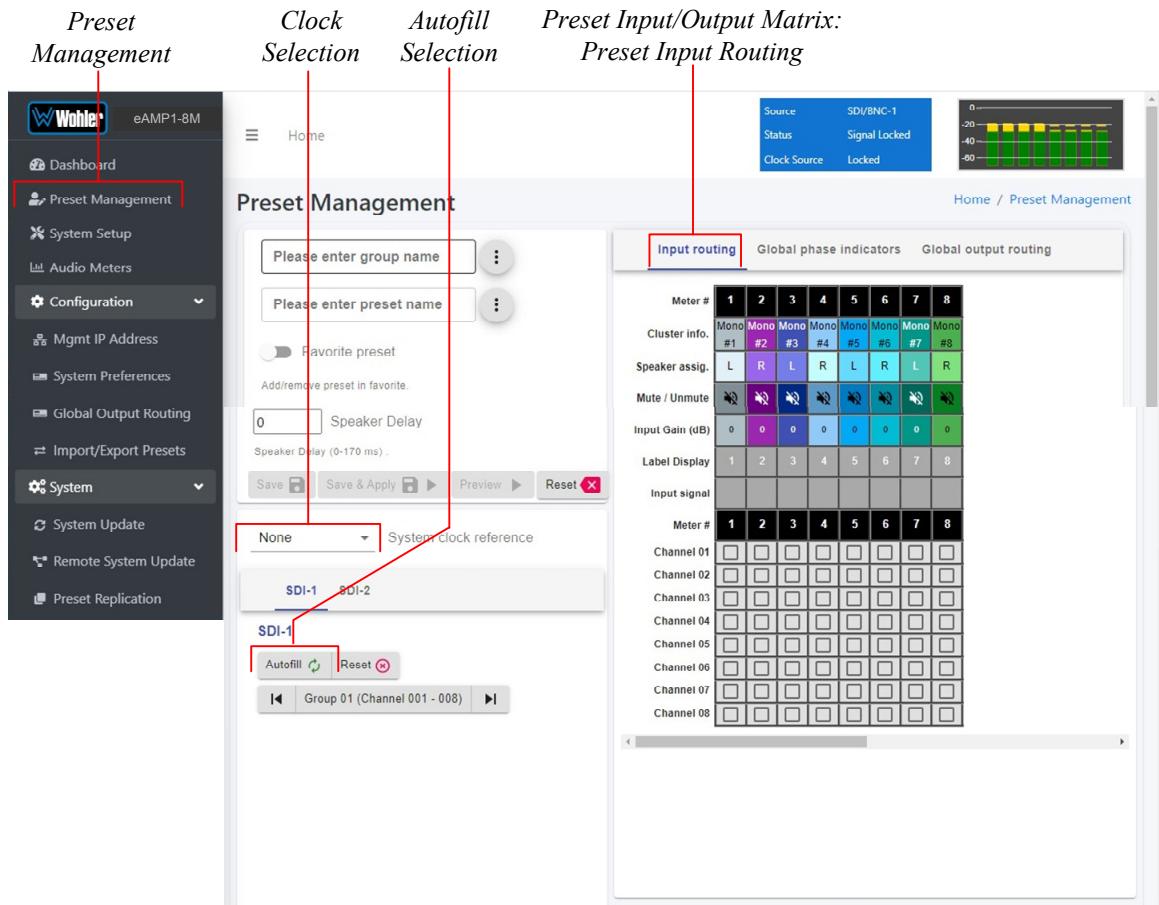

1. **Preset Configuration:** You may create a new Preset, adjust an existing Preset, or create a new Preset from an existing Preset:
 - **To create a new Preset,** enter the name for the new Preset in the field to the left of the word **Preset**. Then make all of the settings needed and save it.
 - **To make changes to an existing Preset,** select it from the pull down list, make the needed changes and save it.
 - **To create a new Preset starting with an existing Preset,** first select the existing Preset from the pull down list. Next, enter the name for the new Preset and save it. Then make the needed changes and save it.

2. **System Clock Reference:** There must be a system clock reference for monitoring to take place. Select a reference from the pull down list. The best choice is a stable, always present clock source locked to house sync. Second to that, use the selected input as the clock. Generally speaking, **Internal** is not the best choice.
3. **Speaker Delay:** If desired, an audio delay may be inserted ahead of the monitor speakers. This delay may range from 0 to 170 mS. Typically, delay is used to align the monitored audio with a video monitored signal.
4. **Input Selection:** Audio from any of the input sources may be applied to the monitoring scheme in any way. A **Preset Input/Output Matrix** is provided on the lower right side of the screen to allow you to assign each channel. Simply select each input source, one at a time, and then check the boxes in the **Matrix** to apply each input channel number to a metered channel number. They do not have to be applied in any specific order. The order of assignment should be chosen to make it easy for the operator to understand. If there are more than 8 or 16 channels in a source, the desired group can also be selected from the box in the lower left of the screen.

Note: All of the SDI channels monitored in a Preset must be from the same SDI 1 or SDI 2 input. Channels from both SDI inputs may not be monitored at once in the same Preset configuration.

5. **Autofill Selection:** If you simply want to map all 8 or 16 input channels to all 16 meters in the same order, click the **Autofill** button. The **Preset Input/Output Matrix** will automatically fill out. To remove all mapping, click the **Reset** button that is adjacent to the **Autofill** button.
6. **Cluster Definition and Naming:** Channel Clusters are a series of channels that are all associated with monitoring the same signal. For example, a Stereo Cluster consists of two channels that together monitor a stereo signal. Clicking a **Cluster Info** box opens a **Cluster** selection box.

In the **Cluster** box, you can select the type of Cluster from a pull down selection. The available **Cluster Type** selections are:

- Mono: The channel will appear within a single-channel cluster.
- Stereo: The channels will appear within a two-channel cluster.
- Surround 5.1: The channels will appear within a 6-channel cluster.
- Surround 7.1: The channels will appear within an 8-channel cluster.
- Custom: You may define a 0 to 8 channel cluster.

Multichannel clusters will expand to the right and overwrite any clusters on overlapping meter positions.

By default, all odd numbered channels will map to the left speakers and all even numbered channels will map to the right speakers. You may change this using the crosspoint selections in the Input/Output Matrix.

A default name will be chosen and it will appear on the metering screen. You may name the Cluster anything you want by simply changing the words within the **Cluster Name** field.

When finished, click **Update**. To undo your change, click **Reset**. To undo all of the Cluster changes for the 8 or 16 channels, click **Reset All**.

7. **Speaker Assign:** Speaker assignments are made automatically when a cluster is set. However, it can be that in an actual signal, the channel assignments may be different than what the automatic assignment assumes. A speaker assignment adjustment is provided for each channel, should you need to override the automatic settings. **It is important to accurately assign the function of each channel so that the Loudness calculations will be accurate.** Clicking a **Speaker Assign** button on a channel opens a box that lets you change the current setting.
8. **Mute/Unmute:** A **Mute/Unmute** control is provided for each channel, although the adjustment will affect all channels in the Cluster. This allows the operator to just see the meters for certain channels and not hear the audio. This is an alternate action control.
9. The **Global Phase Indicators** tab is as shown in Figure 4-16. It allows you to select which channel pairs will receive a phase meter on the **Metering Screen** in this Preset. Generally, it is useful to monitor the relative phase of stereo pairs. However, sometimes each channel of a pair is unrelated to each other. This can be because the channels are used to convey two independent monophonic signals or that one channel may be a Center channel and the other may be a Low Frequency Effects channel. In these instances, the Phase Indicator would almost always indicate an out of phase condition. Because this would be a needless distraction to the operator, switches are provided on this tab to individually turn phase monitoring for each channel pair on or off. By default, the settings for a Preset are the same as the system-wide configuration set on the System Preference tab. However, to make unique settings for this Preset, uncheck **Apply Global Phase Indicator Settings** and then simply click each switch to the desired on or off position. **Select All** and **Reset All** buttons are also provided.

Figure 4–16: Global Phase Indicator Enable / Disable

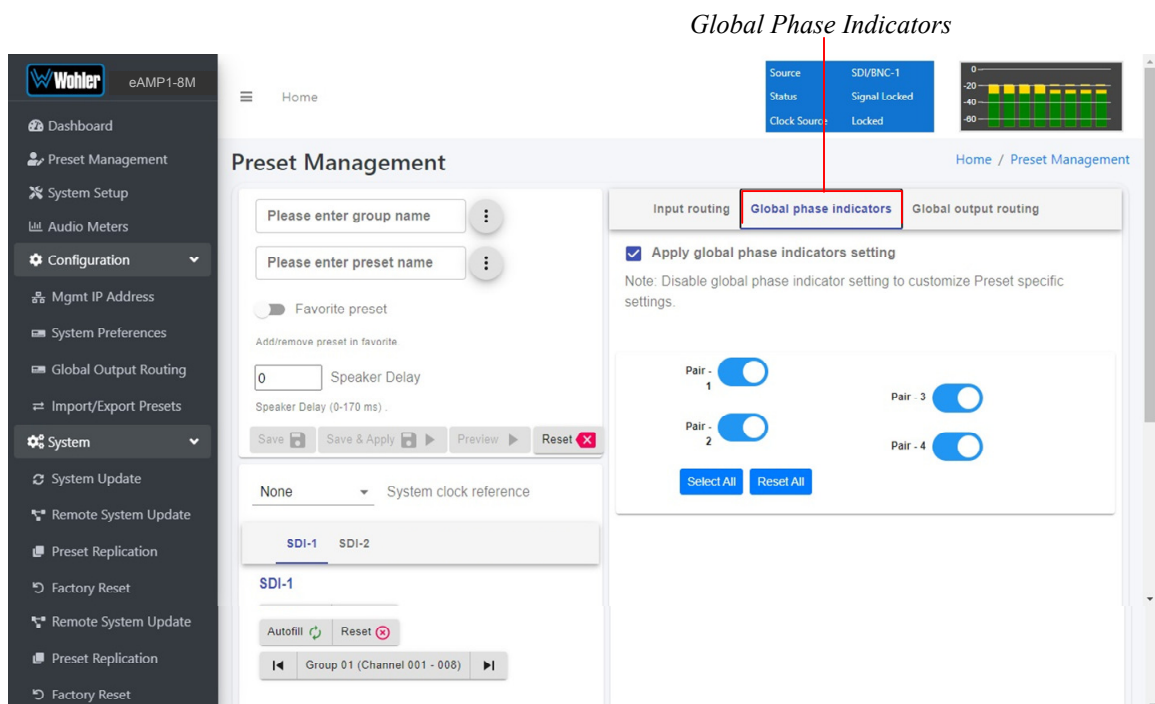

The **Global Output Routing** tab is shown in Figure 4-17. This tab allows you to determine exactly which input channels are routed to which outputs. This very flexible capability allows you to route signals according to Preset or as a default for the whole system. Refer to the **Global Output Routing** section in this chapter to learn the function of each of the checkboxes and of the matrix in this tab.

Note: All of the SDI channels routed must be from the same SDI 1 or SDI 2 input. Channels from both SDI inputs may not be routed at once in the same Preset configuration.

To set up a different input to output routing scheme for the Preset you are creating, click the **Global Output Routing** tab and uncheck the **Apply Global Output Routing** checkbox. You may then adjust the output routing as you desire on this tab and it will only apply to this Preset.

Figure 4-17: Global Output Routing Preset Tab

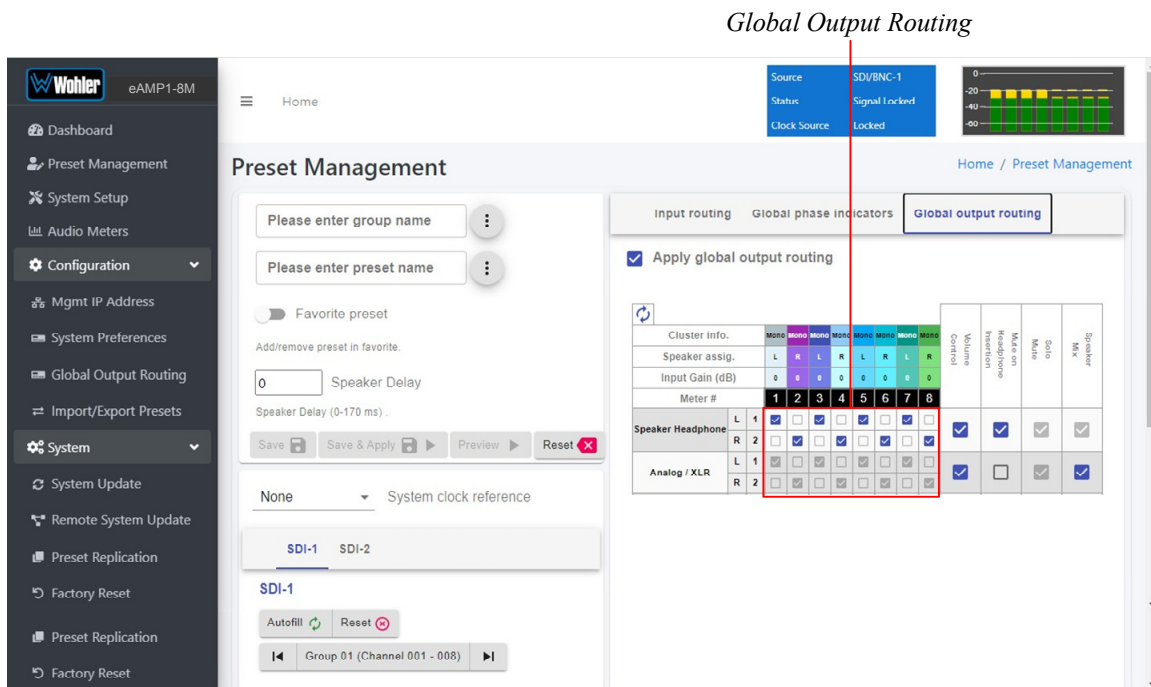

- When you have finished creating a Preset or making changes to a Preset, either click the **Save** button to save the Preset, click the **Save & Apply** button to save the Preset and make it the current Preset, or click the **Reset** button to discard the changes just made. These selections are shown in Figure 4-17.

Global Output Routing

The **Global Output Routing** feature allows channels to be routed or combined and routed in custom ways to various destination outputs. **Global Output Routing** is applied to:

1. Signals monitored using "Input Source select" from the Front Panel,
2. Presets that have been created to apply the Global Output Routing.

Any change to the routing will affect the Presets that have "Apply Global Output Routing" selected.

Select **Global Output Routing** under **Configuration**. This will display the **Global Output Routing** screen. This screen contains a matrix of checkboxes which are an easy way for you to set up the wide variety of inputs to output routing and mixing capabilities. The **Global Output Routing** screen is shown in Figure 4-18.

Figure 4-18: Global Output Routing

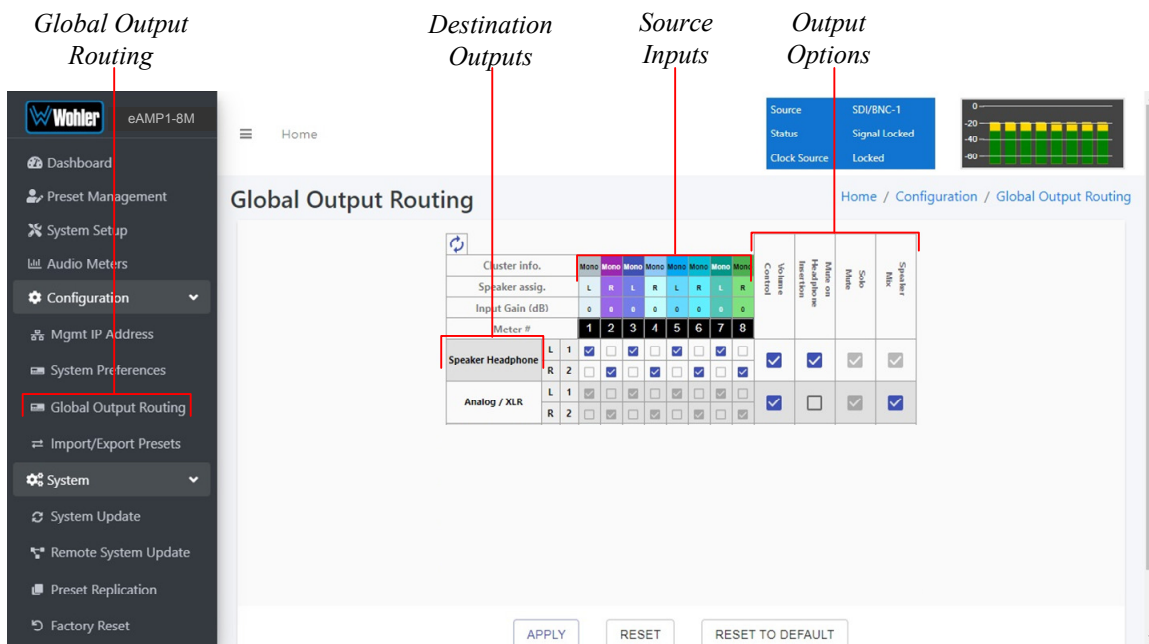

Destination Outputs

On the left of the **Global Output Routing** screen are listed the Destination Outputs. These are the outputs to which any input can be routed. They are as follows:

1. **Speaker/Headphone**: Selected inputs will be sent to the left and right speakers. The default routing is set as per the Speaker Assignment, left channels are sent to the left speaker and right channels are sent to Right speaker.
2. **Analog XLR**: Selected inputs will be mixed to the left and right channels and played through the two Analog XLR Outputs.

Source Inputs

The source inputs which may be routed are described in this section.

1. **Cluster Information:** Cluster information show type of cluster and cluster name.
2. **Speaker Assignment:** Speaker assignment can be used to configure to which speakers the audio is routed to. The possible options are:
 - L** Left
 - R** Right
 - C** Center
 - LFE** Low Frequency Effects
 - Ls** Left Surround
 - Rs** Right Surround
 - Bsl** Back Surround Left
 - Bsr** Back Surround Right
 - S** Mono Surround
3. **Input/Output Matrix:** By checking the various boxes in this matrix, any input channels can be freely routed to any output channels. This flexible channel assignment is called a **Free Mix**. However, when the **Speaker Mix** box is checked in the **Output Options** section, the associated row within the matrix is automatically set to the speaker mix and the checkboxes are grayed out indicating that you may not change them with a **Free Mix** assignment.

Note: All of the SDI channels routed must be from the same SDI 1 or SDI 2 input. Channels from both SDI inputs may not be routed at once in the same Global Routing configuration.

Output Options

The optional settings in this section allow for customization.

1. **Speaker Mix:** This option selects whether an output has the **Speaker Mix** or a **Free Mix** as set in the Routing Input section. The Speaker/Headphone output is always in the **Speaker Mix**.
2. **Solo/Mute:** This setting determines whether or not the outputs are affected by solos and mutes. The Speaker/Headphone output is always affected by solos and mutes. Note also, that all outputs in **Speaker Mix** mode also are affected by solos and mutes.
3. **Mute on Headphone Insertion:** This option controls whether the outputs should be muted upon a headphone insertion. This setting can be adjusted even for outputs whether they are in **Speaker Mix** or **Free Mix** modes.
4. **Volume Control:** This setting determines whether each output pair is adjusted by the **Volume Control** knob. Speaker/Headphone outputs are always affected by the volume control knob, as are any outputs that are in **Speaker Mix** mode.

Typical Questions Regarding Global Output Routing

Routing

The questions and thoughts in this section are commonly asked by people when setting up the Output Routing capability.

What signal outputs can be controlled using the Global Output Routing feature?

All the outputs on the eAMP1-8M/16M can be controlled using the Global Output Routing feature. This includes – Internal Speakers and Analog XLR outputs.

How do I route whatever is being monitored to the XLR?

Using **Global Output Routing**, you may route any signals to the XLR outputs. You may route signals to the XLR outputs using the **Analog/XLR**.



As shown in the above example, signals appearing on Audio Meter channels 9 to 16 are routed to the Analog XLR outputs.

How do I have a downmixed pre-fade output on the Analog XLRs combined with a post-fade output on the Speaker/Headphone?

To downmix a pre-fade output on the Analog/XLR, uncheck the **Volume Control** checkbox for that Analog/XLR pair. For a Post-fade output on the Speaker/Headphone, check **Volume Control** checkbox.

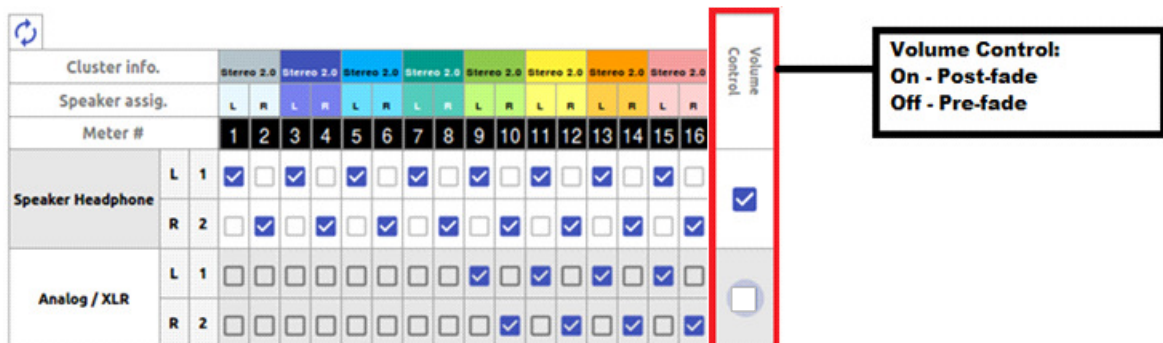

How do I make the XLR outputs follow the Audio Meter screen solos & mutes while the Speaker/Headphone does not?

Make the settings shown in the **Solo / Mute** column:

Solo Mute:
On - Outputs follow user Solo/Mute
Off - Outputs do not follow user Solo/Mutes

Cluster info.		Stereo 2.0		Stereo 2.0		Stereo 2.0		Stereo 2.0		Stereo 2.0		Stereo 2.0		Stereo 2.0		Stereo 2.0		Volume Control	Headphone Insertion	Mute on Headphone	Solo Mute
Speaker assign.		L	R	L	R	L	R	L	R	L	R	L	R	L	R	L	R				
Meter #		1	2	3	4	5	6	7	8	9	10	11	12	13	14	15	16				
Speaker Headphone	L 1	<input checked="" type="checkbox"/>	<input checked="" type="checkbox"/>	<input checked="" type="checkbox"/>	<input checked="" type="checkbox"/>	<input checked="" type="checkbox"/>	<input checked="" type="checkbox"/>	<input checked="" type="checkbox"/>	<input checked="" type="checkbox"/>	<input checked="" type="checkbox"/>	<input checked="" type="checkbox"/>	<input checked="" type="checkbox"/>	<input checked="" type="checkbox"/>	<input checked="" type="checkbox"/>	<input checked="" type="checkbox"/>	<input checked="" type="checkbox"/>	<input checked="" type="checkbox"/>	<input checked="" type="checkbox"/>	<input checked="" type="checkbox"/>	<input checked="" type="checkbox"/>	<input checked="" type="checkbox"/>
	R 2	<input type="checkbox"/>	<input checked="" type="checkbox"/>	<input checked="" type="checkbox"/>	<input checked="" type="checkbox"/>	<input checked="" type="checkbox"/>	<input checked="" type="checkbox"/>	<input checked="" type="checkbox"/>	<input checked="" type="checkbox"/>	<input checked="" type="checkbox"/>	<input checked="" type="checkbox"/>	<input checked="" type="checkbox"/>	<input checked="" type="checkbox"/>	<input checked="" type="checkbox"/>	<input checked="" type="checkbox"/>	<input checked="" type="checkbox"/>	<input checked="" type="checkbox"/>	<input checked="" type="checkbox"/>	<input checked="" type="checkbox"/>	<input checked="" type="checkbox"/>	<input checked="" type="checkbox"/>
Analog / XLR	L 1	<input type="checkbox"/>	<input type="checkbox"/>	<input type="checkbox"/>	<input type="checkbox"/>	<input type="checkbox"/>	<input type="checkbox"/>	<input type="checkbox"/>	<input type="checkbox"/>	<input checked="" type="checkbox"/>	<input type="checkbox"/>	<input checked="" type="checkbox"/>	<input type="checkbox"/>	<input checked="" type="checkbox"/>	<input type="checkbox"/>	<input checked="" type="checkbox"/>	<input type="checkbox"/>	<input checked="" type="checkbox"/>	<input type="checkbox"/>	<input type="checkbox"/>	<input checked="" type="checkbox"/>
	R 2	<input type="checkbox"/>	<input type="checkbox"/>	<input type="checkbox"/>	<input type="checkbox"/>	<input type="checkbox"/>	<input type="checkbox"/>	<input type="checkbox"/>	<input type="checkbox"/>	<input type="checkbox"/>	<input checked="" type="checkbox"/>	<input type="checkbox"/>	<input checked="" type="checkbox"/>	<input type="checkbox"/>	<input checked="" type="checkbox"/>	<input type="checkbox"/>	<input checked="" type="checkbox"/>	<input checked="" type="checkbox"/>	<input type="checkbox"/>	<input type="checkbox"/>	<input checked="" type="checkbox"/>

The setting shown above determines that outputs will follow the Audio Meter screen solos & mutes for the XLR outputs because the checkbox is checked.

How do I route only specific monitored channels to the Analog XLR outputs?

You may route specific channels as shown below. Here Audio Meter channels 9, 11, 13, and 15 are routed to the left analog XLR output and Audio Meter channels 10, 12, 14, and 16 are routed to the right analog XLR output. Unchecked channels are not routed. Make sure the **Speaker Mix** selection is turned off to enable this selection.

Analog / XLR		L 1	2	3	4	5	6	7	8	9	10	11	12	13	14	15	16	Volume Control	Headphone Insertion	Mute on Headphone	Solo Mute
Analog / XLR	L 1	<input type="checkbox"/>	<input type="checkbox"/>	<input type="checkbox"/>	<input type="checkbox"/>	<input type="checkbox"/>	<input type="checkbox"/>	<input type="checkbox"/>	<input type="checkbox"/>	<input checked="" type="checkbox"/>	<input type="checkbox"/>	<input checked="" type="checkbox"/>	<input type="checkbox"/>	<input checked="" type="checkbox"/>	<input type="checkbox"/>	<input checked="" type="checkbox"/>	<input type="checkbox"/>	<input checked="" type="checkbox"/>	<input type="checkbox"/>	<input checked="" type="checkbox"/>	<input type="checkbox"/>
	R 2	<input type="checkbox"/>	<input type="checkbox"/>	<input type="checkbox"/>	<input type="checkbox"/>	<input type="checkbox"/>	<input type="checkbox"/>	<input type="checkbox"/>	<input type="checkbox"/>	<input type="checkbox"/>	<input checked="" type="checkbox"/>	<input type="checkbox"/>	<input checked="" type="checkbox"/>	<input type="checkbox"/>	<input checked="" type="checkbox"/>	<input type="checkbox"/>	<input checked="" type="checkbox"/>	<input checked="" type="checkbox"/>	<input type="checkbox"/>	<input checked="" type="checkbox"/>	<input type="checkbox"/>

How do I keep the internal speakers muted and have audio only on the analog XLR outputs?

In the **Global Output Routing** configuration, do not select any **Speaker Headphone** checkboxes for any meter channels as shown below, and then select the desired meters for Analog XLR. In this way, the internal speakers will always be muted, but the audio will appear on the Analog XLR outputs (for amplified external speakers). Make sure that the **Speaker Mix** checkbox selection is unchecked for Analog/XLR.

Cluster info.		Stereo 2.0		Stereo 2.0		Stereo 2.0		Stereo 2.0		Stereo 2.0		Stereo 2.0		Stereo 2.0		Volume Control	Mute on Headphone Insertion	Solo Mute	Speaker Mix
Speaker assign.	Meter #	L	R	L	R	L	R	L	R	L	R	L	R						
Speaker Headphone	L 1	<input type="checkbox"/>	<input type="checkbox"/>	<input type="checkbox"/>	<input type="checkbox"/>	<input type="checkbox"/>	<input type="checkbox"/>	<input type="checkbox"/>	<input type="checkbox"/>	<input type="checkbox"/>	<input type="checkbox"/>	<input type="checkbox"/>	<input type="checkbox"/>	<input checked="" type="checkbox"/>	<input checked="" type="checkbox"/>	<input checked="" type="checkbox"/>	<input checked="" type="checkbox"/>		
	R 2	<input type="checkbox"/>	<input type="checkbox"/>	<input type="checkbox"/>	<input type="checkbox"/>	<input type="checkbox"/>	<input type="checkbox"/>	<input type="checkbox"/>	<input type="checkbox"/>	<input type="checkbox"/>	<input type="checkbox"/>	<input type="checkbox"/>	<input type="checkbox"/>	<input type="checkbox"/>	<input type="checkbox"/>	<input type="checkbox"/>	<input type="checkbox"/>		
Analog / XLR	L 1	<input checked="" type="checkbox"/>	<input checked="" type="checkbox"/>	<input checked="" type="checkbox"/>	<input checked="" type="checkbox"/>	<input checked="" type="checkbox"/>	<input checked="" type="checkbox"/>	<input checked="" type="checkbox"/>	<input checked="" type="checkbox"/>	<input checked="" type="checkbox"/>	<input checked="" type="checkbox"/>	<input checked="" type="checkbox"/>	<input checked="" type="checkbox"/>	<input checked="" type="checkbox"/>	<input checked="" type="checkbox"/>	<input checked="" type="checkbox"/>	<input type="checkbox"/>		
	R 2	<input type="checkbox"/>	<input checked="" type="checkbox"/>	<input checked="" type="checkbox"/>	<input checked="" type="checkbox"/>	<input checked="" type="checkbox"/>	<input checked="" type="checkbox"/>	<input checked="" type="checkbox"/>	<input checked="" type="checkbox"/>	<input checked="" type="checkbox"/>	<input checked="" type="checkbox"/>	<input checked="" type="checkbox"/>	<input checked="" type="checkbox"/>	<input type="checkbox"/>	<input type="checkbox"/>	<input type="checkbox"/>	<input type="checkbox"/>		

How do I ensure that the outputs are automatically muted when the Headphone jack is inserted?

In the **Global Output Routing** configuration, if the **Mute on Headphone Insertion** checkbox is ON then the outputs get automatically muted when a headphone is inserted into the Headphone jack.

As shown below, if a headphone is inserted then the output on the Analog XLRs will be muted.

Mute on Headphone Insertion:
On: Outputs are muted when Headphone Jack is inserted
Off: Outputs are not muted when Headphone Jack is inserted.

Cluster info.		Stereo 2.0		Stereo 2.0		Stereo 2.0		Stereo 2.0		Stereo 2.0		Stereo 2.0		Volume Control	Mute on Headphone Insertion	Solo Mute	Speaker Mix
Speaker assign.	Meter #	L	R	L	R	L	R	L	R	L	R	L	R				
Speaker Headphone	L 1	<input type="checkbox"/>	<input type="checkbox"/>	<input type="checkbox"/>	<input type="checkbox"/>	<input type="checkbox"/>	<input type="checkbox"/>	<input type="checkbox"/>	<input type="checkbox"/>	<input type="checkbox"/>	<input type="checkbox"/>	<input type="checkbox"/>	<input type="checkbox"/>	<input checked="" type="checkbox"/>	<input checked="" type="checkbox"/>	<input checked="" type="checkbox"/>	<input checked="" type="checkbox"/>
	R 2	<input type="checkbox"/>	<input type="checkbox"/>	<input type="checkbox"/>	<input type="checkbox"/>	<input type="checkbox"/>	<input type="checkbox"/>	<input type="checkbox"/>	<input type="checkbox"/>	<input type="checkbox"/>	<input type="checkbox"/>	<input type="checkbox"/>	<input type="checkbox"/>	<input type="checkbox"/>	<input type="checkbox"/>	<input type="checkbox"/>	<input type="checkbox"/>
Analog / XLR	L 1	<input checked="" type="checkbox"/>	<input checked="" type="checkbox"/>	<input checked="" type="checkbox"/>	<input checked="" type="checkbox"/>	<input checked="" type="checkbox"/>	<input checked="" type="checkbox"/>	<input checked="" type="checkbox"/>	<input checked="" type="checkbox"/>	<input checked="" type="checkbox"/>	<input checked="" type="checkbox"/>	<input checked="" type="checkbox"/>	<input checked="" type="checkbox"/>	<input checked="" type="checkbox"/>	<input type="checkbox"/>	<input checked="" type="checkbox"/>	<input type="checkbox"/>
	R 2	<input type="checkbox"/>	<input checked="" type="checkbox"/>	<input checked="" type="checkbox"/>	<input checked="" type="checkbox"/>	<input checked="" type="checkbox"/>	<input checked="" type="checkbox"/>	<input checked="" type="checkbox"/>	<input checked="" type="checkbox"/>	<input checked="" type="checkbox"/>	<input checked="" type="checkbox"/>	<input checked="" type="checkbox"/>	<input checked="" type="checkbox"/>	<input type="checkbox"/>	<input type="checkbox"/>	<input type="checkbox"/>	<input type="checkbox"/>

How do I ensure that my outputs are pre-faded but follow the solo-mutes on the web interface? This will allow us to monitor only the unmuted/solo Audio Meter channels on amplified stereo speakers connected to the Analog XLR's.

In the **Output Routing** setting, for the Analog XLR outputs, keep the **Volume Control** checkbox unchecked and the **Solo/Mute** checkbox checked. This ensures that the Volume Control is **not** applied to the outputs, while the Solos/Mutes **are**.

Cluster info.		Stereo 2.0		Stereo 2.0		Stereo 2.0		Stereo 2.0		Stereo 2.0		Stereo 2.0		Volume Control	Mute on Headphone Insertion	Solo Mute	Speaker Mix
Speaker assign.	Meter #	L	R	L	R	L	R	L	R	L	R	L	R				
Speaker Headphone	L 1	<input type="checkbox"/>	<input type="checkbox"/>	<input type="checkbox"/>	<input type="checkbox"/>	<input type="checkbox"/>	<input type="checkbox"/>	<input type="checkbox"/>	<input type="checkbox"/>	<input type="checkbox"/>	<input type="checkbox"/>	<input type="checkbox"/>	<input type="checkbox"/>	<input checked="" type="checkbox"/>	<input checked="" type="checkbox"/>	<input checked="" type="checkbox"/>	<input checked="" type="checkbox"/>
	R 2	<input type="checkbox"/>	<input type="checkbox"/>	<input type="checkbox"/>	<input type="checkbox"/>	<input type="checkbox"/>	<input type="checkbox"/>	<input type="checkbox"/>	<input type="checkbox"/>	<input type="checkbox"/>	<input type="checkbox"/>	<input type="checkbox"/>	<input type="checkbox"/>	<input type="checkbox"/>	<input type="checkbox"/>	<input type="checkbox"/>	<input type="checkbox"/>
Analog / XLR	L 1	<input checked="" type="checkbox"/>	<input checked="" type="checkbox"/>	<input checked="" type="checkbox"/>	<input checked="" type="checkbox"/>	<input checked="" type="checkbox"/>	<input checked="" type="checkbox"/>	<input checked="" type="checkbox"/>	<input checked="" type="checkbox"/>	<input checked="" type="checkbox"/>	<input checked="" type="checkbox"/>	<input checked="" type="checkbox"/>	<input checked="" type="checkbox"/>	<input type="checkbox"/>	<input checked="" type="checkbox"/>	<input checked="" type="checkbox"/>	<input type="checkbox"/>
	R 2	<input type="checkbox"/>	<input checked="" type="checkbox"/>	<input checked="" type="checkbox"/>	<input checked="" type="checkbox"/>	<input checked="" type="checkbox"/>	<input checked="" type="checkbox"/>	<input checked="" type="checkbox"/>	<input checked="" type="checkbox"/>	<input checked="" type="checkbox"/>	<input checked="" type="checkbox"/>	<input checked="" type="checkbox"/>	<input checked="" type="checkbox"/>	<input type="checkbox"/>	<input type="checkbox"/>	<input type="checkbox"/>	<input type="checkbox"/>

Preset Replication

Preset Replication is available if the OPTe Package is purchased. This feature allows you to copy presets from a master unit to multiple eAMP1-8M/16M units. This can save a lot of setup time if multiple units all need basically the same setup.

To start Preset Replication, click on the **Preset Replication** tab on the master unit. This will start the unit discovery process and will list all the eAMP1-8M/16M units that you currently have on your network. The discovery process will continue for a period of 2 minutes. However, you may stop the discovery process sooner if you believe all the units in the network have been discovered. Simply click the **Stop Scan** button.

Figure 4-19: Preset Replication Scanning Screen

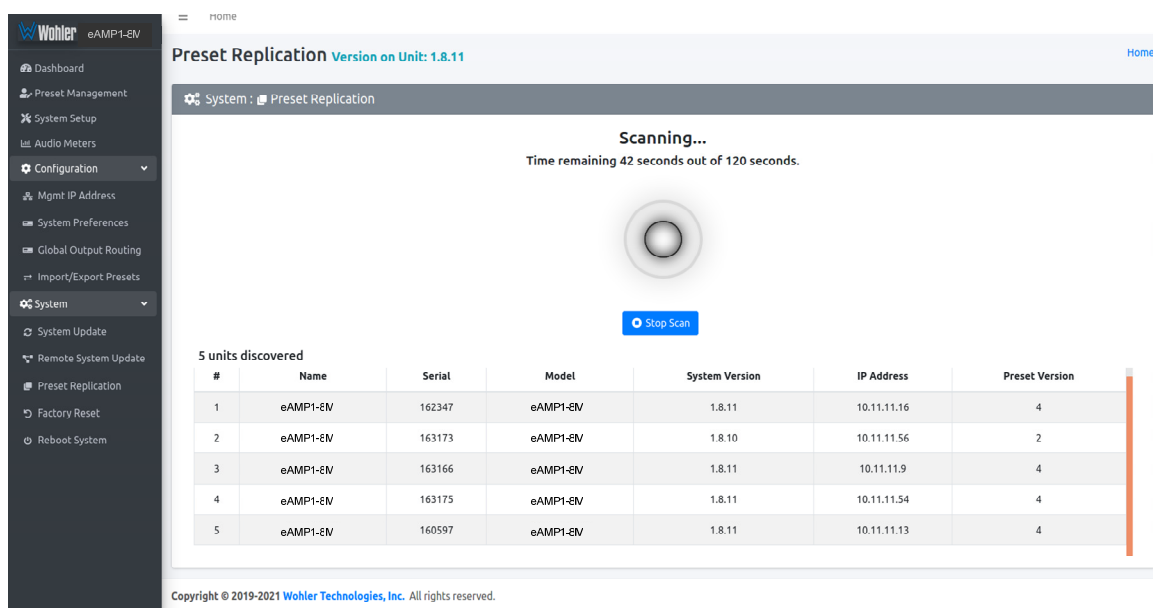

The screenshot displays the 'Preset Replication' interface. At the top, it indicates 'System : Preset Replication' and 'Version on Unit: 1.8.11'. The main area shows a 'Scanning...' status with a progress indicator and a 'Stop Scan' button. Below this, a table lists 5 discovered units with the following data:

#	Name	Serial	Model	System Version	IP Address	Preset Version
1	eAMP1-EV	162347	eAMP1-EV	1.8.11	10.11.11.16	4
2	eAMP1-EV	163173	eAMP1-EV	1.8.10	10.11.11.56	2
3	eAMP1-EV	163166	eAMP1-EV	1.8.11	10.11.11.9	4
4	eAMP1-EV	163175	eAMP1-EV	1.8.11	10.11.11.54	4
5	eAMP1-EV	160597	eAMP1-EV	1.8.11	10.11.11.13	4

Copyright © 2019-2021 Wohler Technologies, Inc. All rights reserved.

Once all the units are discovered you may either copy the presets that are currently created on the Master unit or can use an external preset file that you want to copy to any or all of the Target units. **Note that any and all of the Presets that may already be contained in each Target unit will be erased by copying the new Presets.**

Figure 4-20: Preset Replication Target Selection Screen

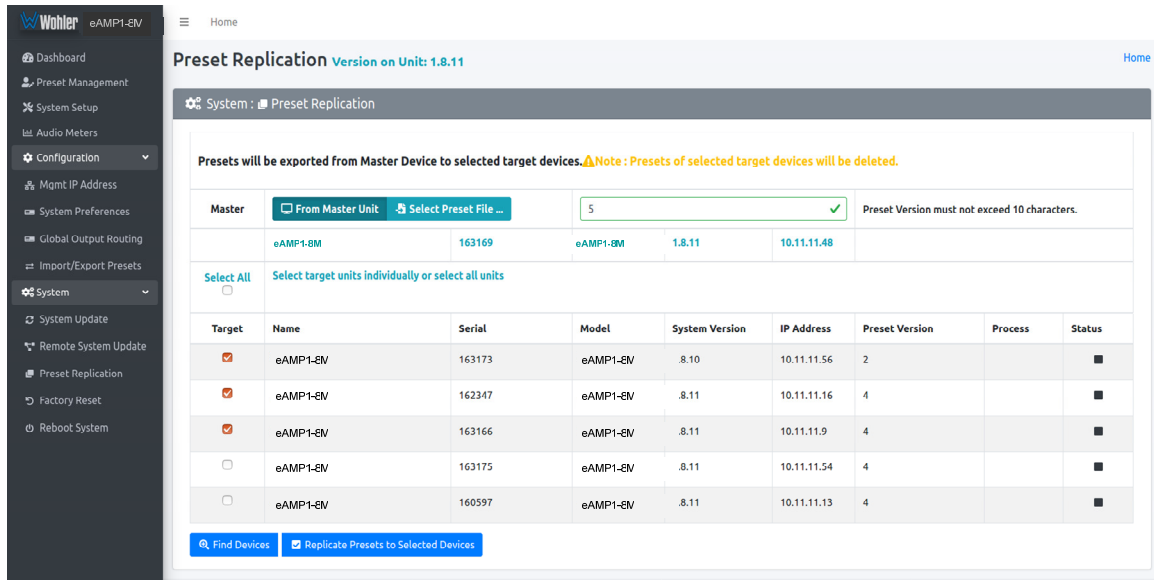

Click either **From Master Unit** or **Select Preset File**. This determines the source of the Presets to be copied. Preset Files would be files that you have previously stored in the computer running the Web GUI.

You may add a descriptive name or version to the Presets being copied. This may aid in remembering what tag or version of the presets are available on the unit. The Preset name or version may be up to 10 characters in length.

Next, select the Target units from the list of units shown by checking or unchecking each of the **Target** boxes at the left. Alternatively, you may click **Select All** to select all of the units. Then select the **Replicate Presets to Selected Devices** button. The progress of the Preset replication for each unit, as the Presets are being copied, will be displayed in the **Process** column. When all of the Presets have been copied to each of the selected units, you may leave this screen.

Import/Export Presets

Use the **Import / Export Presets** page to manage the Preset database in the eAMP1-8M/16M. You may export the Preset database onto the computer hard drive for security backup purposes or as a means to transfer it to another eAMP1-8M/16M. Likewise, it can be used to import a Preset database from the computer hard drive into the eAMP1-8M/16M. In this way, a Preset configuration may be only devised once and then duplicated into all of the eAMP1-8M/16M units in a system, saving significant effort.

The eAMP1-8M/16M will create Preset Tags for each set of Presets. Refer to Figure 4-21. You may also change these Preset Tags, using the Preset Change Field. They allow you to quickly resolve questions about which Presets on various units are the most up to date. They will also allow you to determine whether Presets have been modified. If the Preset Tag displayed contains the suffix "-dirty" then at least one Preset has been changed in some way.

While exporting the file, the Preset Tag is appended to the filename, this allows you to store multiple Preset files with different file name. For example, if the Preset Tag is v1.0.0 then for eAMP1-8M/16M the default filename would be "**wohler_presets_eAMP1-8M** -v1.0.0.pdb" or "**wohler_presets_eAMP1-16M** -v1.0.0.pdb" Do not change the file suffix and prefix (marked in red). However, you may change the Preset Tag to any number or text to suit your requirements.

Figure 4-21: Database Export

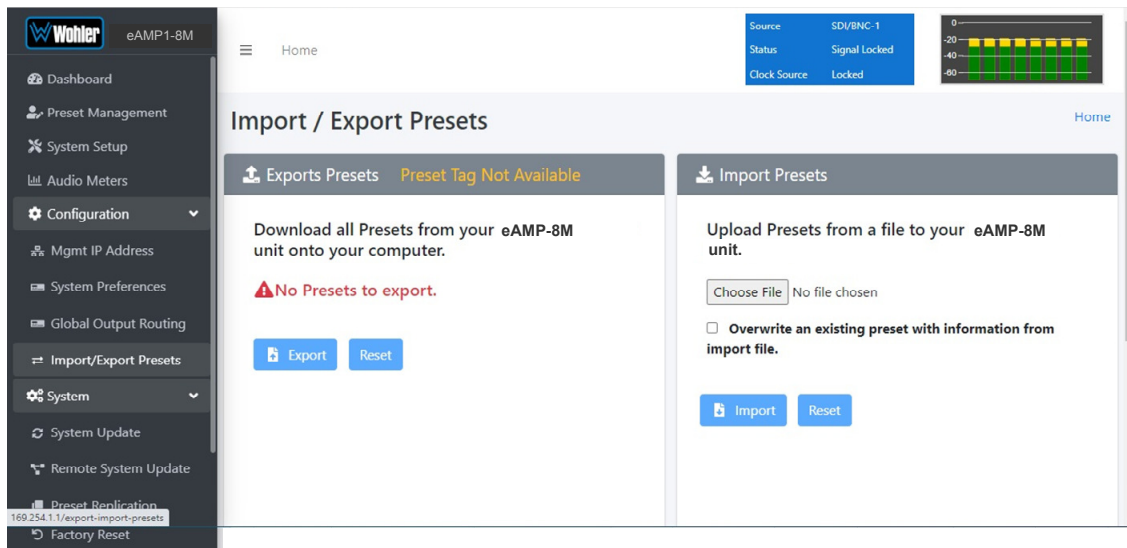

Export Configuration

Use the following steps to save the Preset configuration in the eAMP1-8M/16M to the computer hard drive:

1. If you need to, revise the Preset Tag name, observing the advice in the advice in the previous section.
2. Click the **Export** button on the **Import / Export Presets** page, as shown in

Figure 4-21.

3. A small **Verify** window will appear:

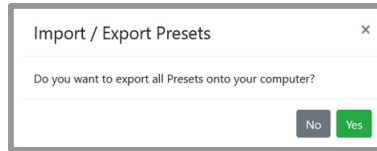

4. Click **Yes** to proceed with writing the Preset data to the hard drive. The copying will proceed. After the Preset data has been written, a screen will appear, explaining what has been exported in an Export Presets Summary. It will also note whether there were any errors in the process. If there were any errors, repeat these steps to try again.

Import Configuration

Use the following steps to copy the Preset configuration into the eAMP1-8M/16M:

1. Click the **Browse** button as shown in Figure 4-21 and select the Preset Tag you would like to import.
2. If you want to allow existing Presets to be overwritten with imported Presets of the same name, check the **Overwrite an existing Preset** box. It is a good idea to do this.
3. Click the **Import** button. The copying will proceed. When complete, a screen will appear, explaining what has been imported in an Import Presets Summary. It will also note whether there were any errors in the process. If there were any errors, repeat these steps to try again.

System Setup

Click on **System Setup** to find two tabs, each containing important information about the eAMP1-8M/16M. These tabs are explained in the following two sections.

System Information

This tab displays a variety of information about the eAMP1-8M/16M. It is shown in Figure 4-22. This information could be useful to view if you are contacting Wohler Technical Service.

Figure 4-22: System Information Tab

The screenshot shows the 'System Information' tab in the Wohler eAMP1-8M/16M web interface. The interface includes a sidebar with navigation options, a top status bar, and a main content area with 'System Information' and 'Licenses' tabs. The 'System Information' tab is active, displaying software and unit information.

System Setup

System Information Licenses

Software Information

System Status	Valid
System Version	0.0.32
919500	
Type	Mainboard
State	Valid
Version	0.0.32
Revision	AA
FPGA Version	0x23071401
MAC Address	00:0a:35:00:01:50

Unit Information

Serial Number	168227
System IP Address	192.168.10.23
MAC Address	00:0a:35:00:01:50
Name	eAMP1-S16-2MDA ✓

Apply

System Log Information

Copyright © Wohler Technologies, Inc. All rights reserved.

Licenses

This tab displays the license number for each of the modules or features in the eAMP1-8M/16M. It is shown in Figure 4-23. You will use this tab to enter any new license numbers that you purchase. Contact Wohler Sales to obtain new license numbers. If you need help, Wohler Technical Service will be happy to assist you in installing these numbers.

Figure 4-23: Licenses Tab

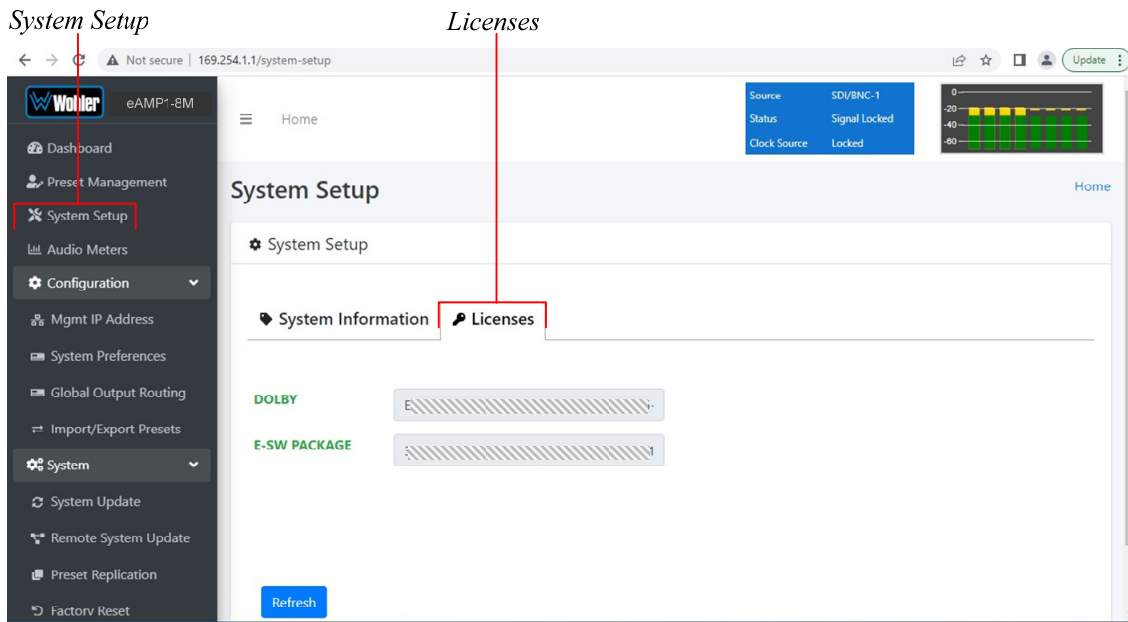

To enter the license key provided to you by Wohler Customer Service, use the following steps:

1. Click the field to the right of the input or module desired.
2. Enter the license key in the box.
3. Repeat Steps 1 and 2 for any other license keys that you want to enter.
4. Click the **Refresh** button to save the information. Each new license will be immediately available for use.

Factory Reset

The **Factory Reset** function should be used with caution. It deletes all of the settings you have programmed into the system. It returns the system to the way it was when received new from the factory. After using this function, you will need to reprogram everything from the start.

Figure 4–24: Factory Reset

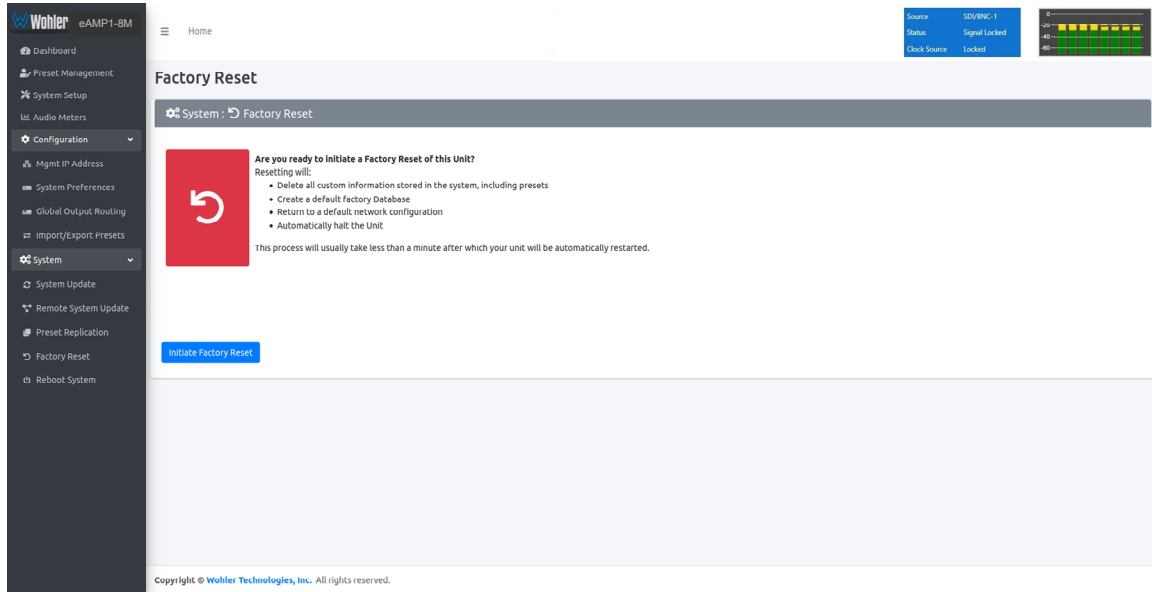

If you have any doubt as to whether you should perform a Factory Reset, **do not** click the **Initiate Factory Reset** button. Contact Wohler Technical Service for advice.

Note: **Factory Reset** will also reset your IP address to the default one. After a Factory Reset, the IP Settings will need to be updated. The default IP address for the unit is determined based upon the Mac address. It is 169.254.1.xx where xx is the last octet of the management Mac address. For example, if the Mac address is b4:ed:54:d0:04:28 then the IP address would be 169.254.1.40 (40 is the decimal equivalent for the last octet of Mac address 28.)

Reboot System

The **Reboot System** page allows you to reboot an eAMP-S8/S16-2MDA remotely. The **Reboot System** page is shown in Figure 4-25. This function is normally only used upon request from Wohler Technical Service to troubleshoot or correct an issue.

The **Reboot System** function should be used with a bit of caution. It puts the eAMP1-8M/16M out of service for several minutes while it is rebooting, and this may unexpectedly interfere with the use of the product by the remote operator.

Figure 4–25: Reboot System

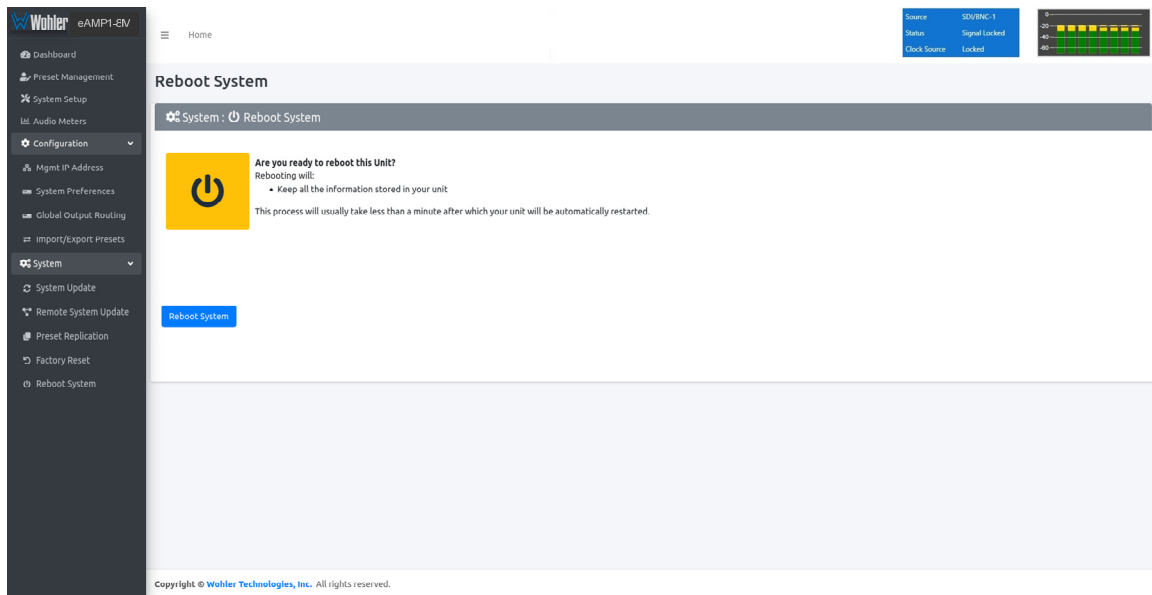

If you have any doubt as to whether you should reboot the remote eAMP1-8M/16M, **do not** click the **Reboot System** button. Contact Wohler Technical Service for advice.

APPENDIX A: Software Upgrades

Introduction

This chapter describes how to download a software update file to your computer, transfer it to a USB flash drive and install the updated into an eAMP1-8M/16M.

Download the Software

The eAMP1-8M/16M software update can be found at <http://www.wohler.com>, under Product Downloads on the Products > eAMP1-8M/16M page, in Support > Downloads > Drivers & Software, or contact Wohler Customer Support for more information.

Unzip the downloaded update files to reveal two files. One will have a suffix of **.wx** and the other will have a suffix of **.md5sum**. Both files are needed for the upgrade.

Update Methods

There are several software update methods. Select one of them, depending upon your needs:

1. Local update from the front panel of the eAMP1-8M/16M: This straightforward method does not require the use of the Web GUI. A flash drive containing the update is plugged into the front panel USB socket and the update is then accomplished using the self-contained menu system. If this method seems most suitable, then refer to the [Local Update from the Front Panel](#) section of this chapter.
2. Remote update using the Web GUI with a flash drive connected to the eAMP1-8M/16M: It may be more convenient to update the product using a flash drive plugged into its front panel USB socket, but controlled remotely via the Web GUI. To update the product this way, refer to the [Updating via the Web GUI](#) section of this chapter.
3. Remote update without a flash drive: This method allows you to update a networked eAMP1-8M/16M remotely without plugging a flash drive into its front panel USB socket. To update the product this way, refer to the [Updating an eAMP1-8M/16M Remotely](#) section of this chapter.
4. Update multiple units remotely at once: This method allows you to update multiple networked eAMP1-8M/16M units at once, without plugging flash drives into their front panel USB sockets. To update products this way, refer to the [Updating Multiple eAMP1-8M/16M Units Remotely](#) section of this chapter.

Local Update from the Front Panel

Use the following steps to update the eAMP1-8M/16M software:

1. Copy the unzipped Wohler Update Package file(s) from your computer to the root directory (not inside of a folder) of a USB flash drive. It must be FAT32 file type, and does not need to be empty. Refer to the [Download the Software](#) section of this chapter for the specifics of download and file transfer to the USB flash drive.
2. Insert the USB flash drive with eAMP1-8M/16M update package(s) into the front panel USB jack.
3. From the **Menu** screen, touch **System Options**. The screen shown in Figure A-1 will appear.

Figure A-1 - System Options Screen

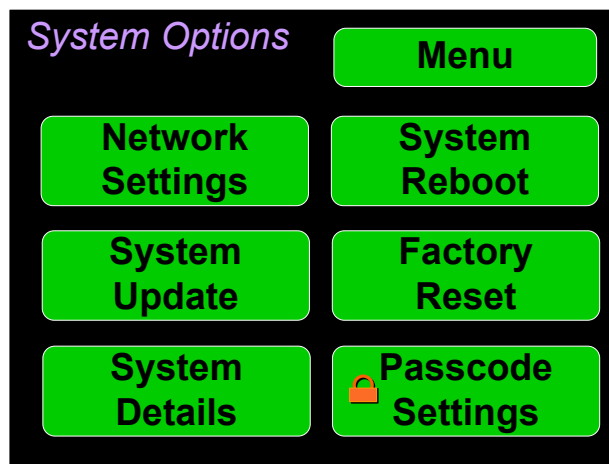

4. In the **System Options** menu, touch **System Update**. The **Software Upgrade** screen will appear, as shown in Figure A-2.

Figure A-2 - Software Upgrade Screen

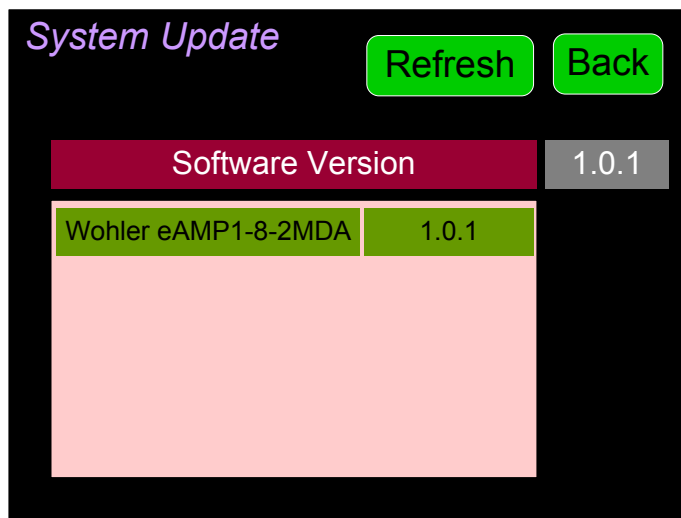

5. The new software version that is in the flash drive will be shown in the

Software Version screen. To cancel the upgrade at this point for any reason, touch **Back**. To proceed, touch the software version entry in the **Software Version** screen. A screen will appear, as shown in Figure A-3.

Figure A-3 - Upgrade Verify

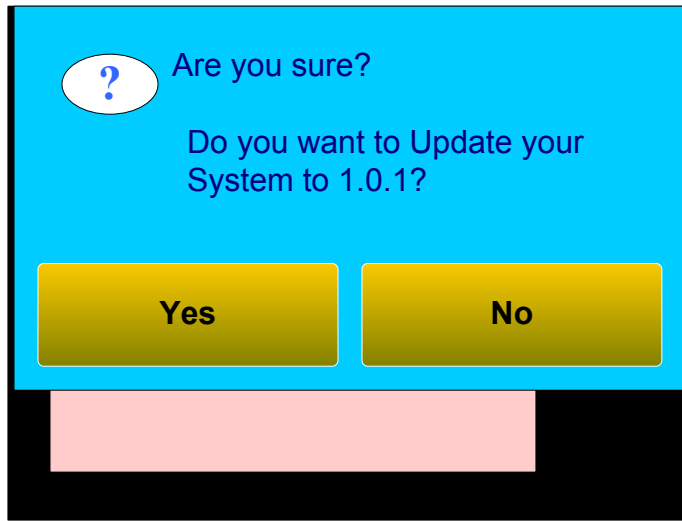

6. To proceed, touch **Yes**. To back out, touch **No**. After you touch **Yes**, the screen will change, as shown in Figure A-4. The screen will display "Software Upgrade in Progress" until the upgrade is complete.

Figure A-4 - Upgrading System

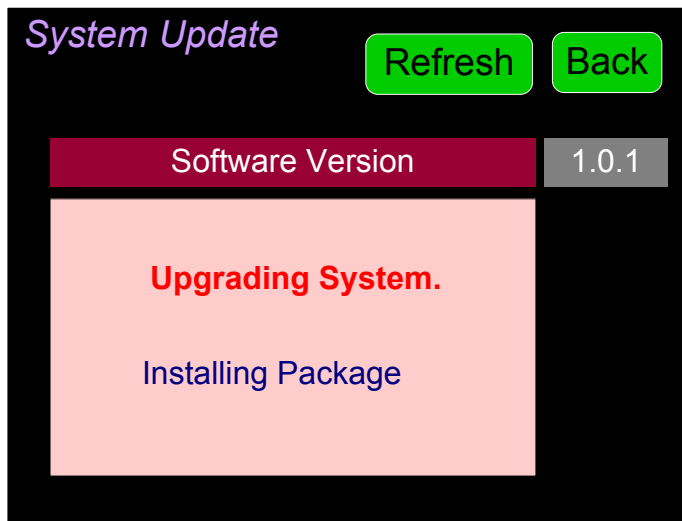

After the software update starts, the text on the left screen will change periodically to indicate the progression of the upgrade. The upgrade may take 5 minutes or more, after which the eAMP1-8M/16M will restart. After the system has completed its restart cycle and is once again operational, you may then remove the flash drive.

Important:

Do not interrupt or remove power to the eAMP1-8M/16M, or remove the USB drive during the installation process. Doing so could crash the eAMP1-8M/16M software.

Updating via the Web GUI using a Flash Drive

Use the following steps to update the eAMP1-8M/16M software:

1. Copy the unzipped Wohler Update Package file(s) from your computer to the root directory (not inside of a folder) of a USB flash drive. It must be FAT32 file type, and does not need to be empty. Refer to the [Download the Software](#) section of this chapter for the specifics of download and file transfer to the USB flash drive.
2. Connect to the eAMP1-8M/16M with the Wohler Web GUI. Navigate to the **System | System Update** menu, as shown in Figure A-5.

Figure A-5 – System Update Menu

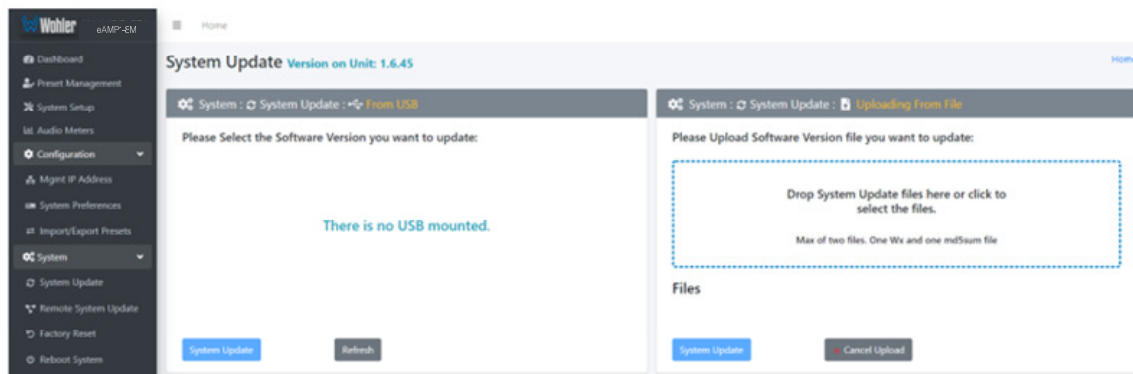

3. Click on the **Refresh** button.
4. Available software update(s) are shown as in Figure A-6. Click the one you want, followed by clicking the **System Update** button.

Figure A-6 – Available Software Updates

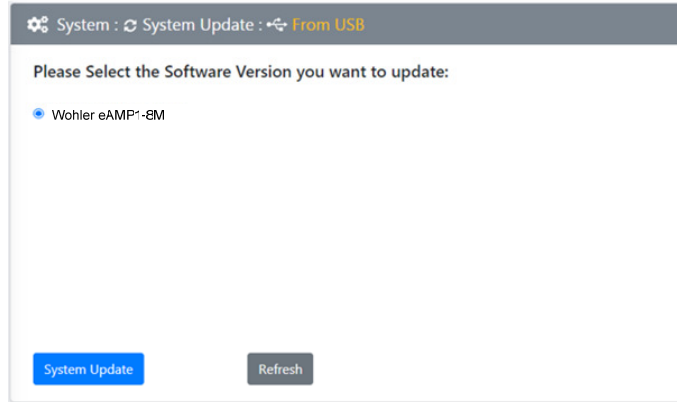

5. After clicking the System Update button, a verification screen displays as shown in Figure A-7. If you agree that the correct update version has been selected, click the **Yes** button.

Figure A-7 – System Update Verification

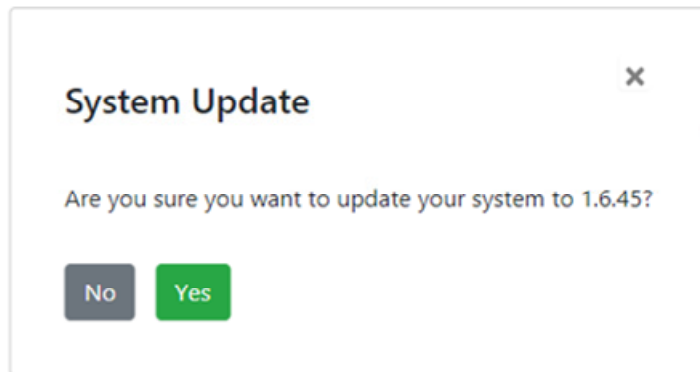

6. Next, the update begins, showing the screen in Figure A-8. The circle in the center of the screen, along with status messages below it, will indicate the progress of the update.

Figure A-8 – Software Upgrade in Progress

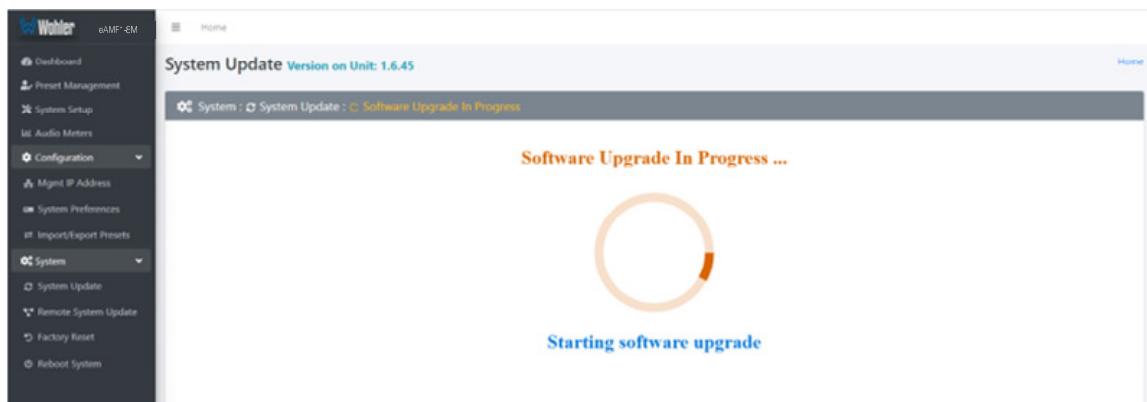

7. At this point, wait for the update to complete. It may take several minutes,

but **it is critical not to disturb the eAMP1-8M/16M or the Web GUI** until the update process is complete. When it is complete, the eAMP1-8M/16M will restart.

Updating an eAMP1-8M/16M Remotely

Use the following steps to update the eAMP1-8M/16M software:

1. The Software Update files you downloaded earlier must be in the same computer that is running the Web GUI. Connect to the eAMP1-8M/16M with the Wohler Web GUI. Navigate to the **System | System Update** menu. Click within the large blue dotted line rectangle at the right of the screen. A file selection window will open, as shown in Figure A-9.

Figure A-9 – System Update Menu

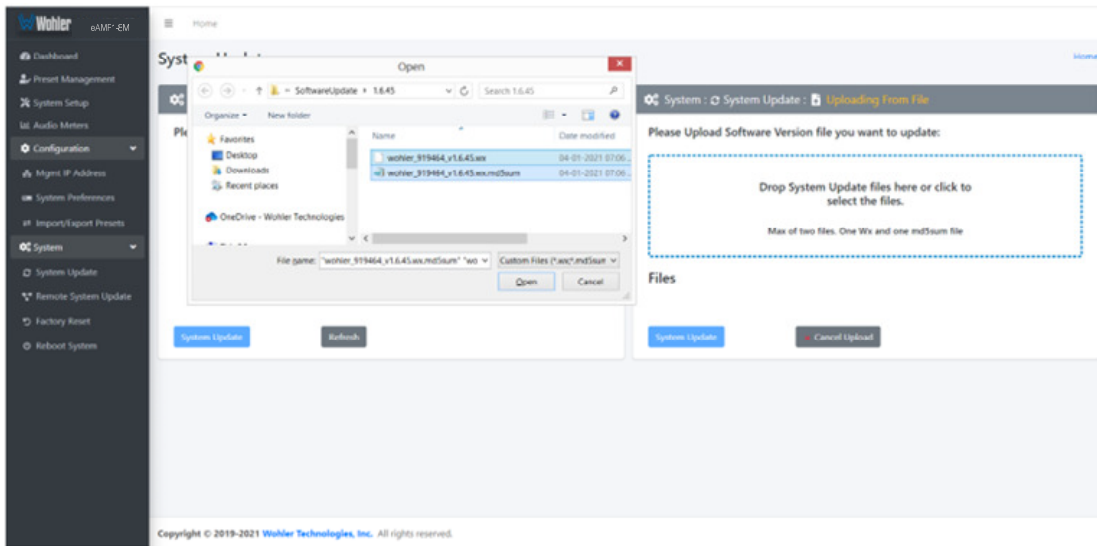

2. Click the two update files. One will have a suffix of **.wx** and the other will have a suffix of **.md5sum**. If you make a mistake and click the wrong file(s), click the **Cancel Upload** button and try again. When the files have uploaded, the **System Update** button will be enabled. Click it. If there is a problem with the files as this point one of the screens shown in Figures A-10 or A-11 will appear. In that case follow the directions on the screen to retry. If there are no problems, the update will proceed and the screen shown in Figure A-8 will appear.

Figure A-10 – Invalid System File Version

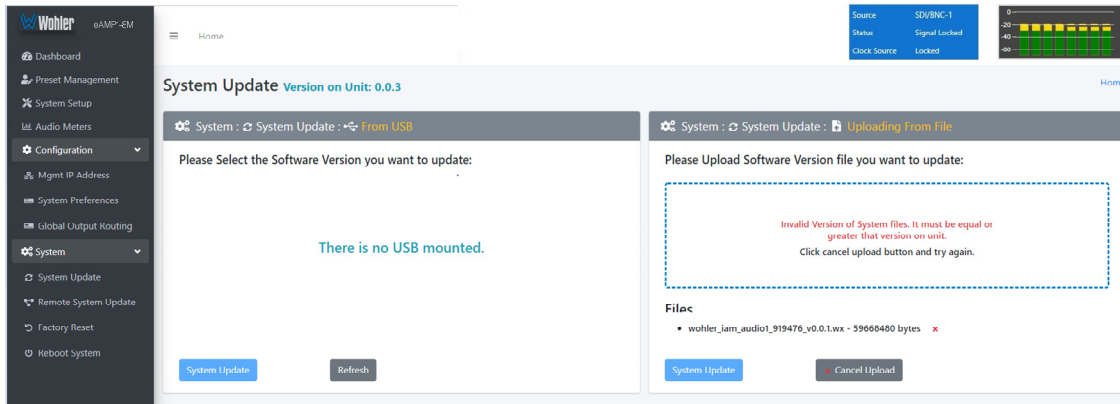
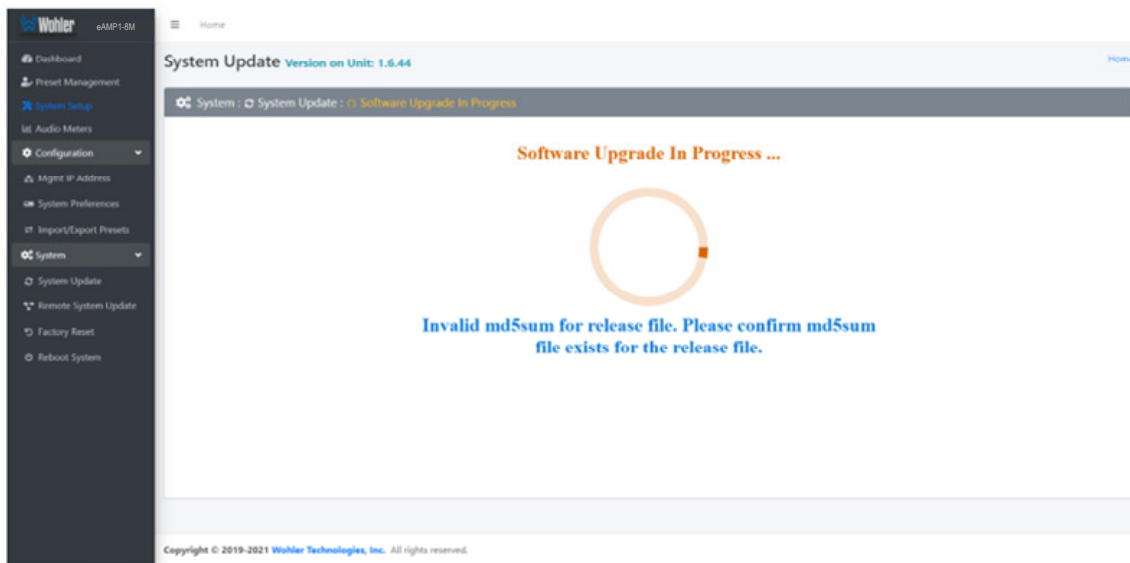

Figure A-11 – Invalid Checksum



3. At this point, wait for the update to complete. It may take several minutes, but **it is critical not to disturb the eAMP1-8M/16M or the Web GUI** until the update process is complete. When it is complete, the eAMP1-8M/16M will restart.

Updating Multiple Units Remotely

Use the following steps to update one or more eAMP1-8M/16M units remotely by transferring the software from a previously updated eAMP1-8M/16M:

1. If any of the eAMP1-8M/16M units that you intend to update remotely may be in use, contact the people using them and let them know what you will be doing. The eAMP1-8M/16M units being updated will be temporarily out of service.
2. Use the Wohler Web GUI to connect to an eAMP1-8M/16M already containing the latest update. This will be referred to as the **Master Unit**. Navigate to the **System | System Update | Remote System Update** menu. The screen shown in Figure A-12 will appear and the Web GUI will scan the network for any active eAMP1-8M/16M units.

Figure A-12 – Scanning for eAMP1-8M/16M Units

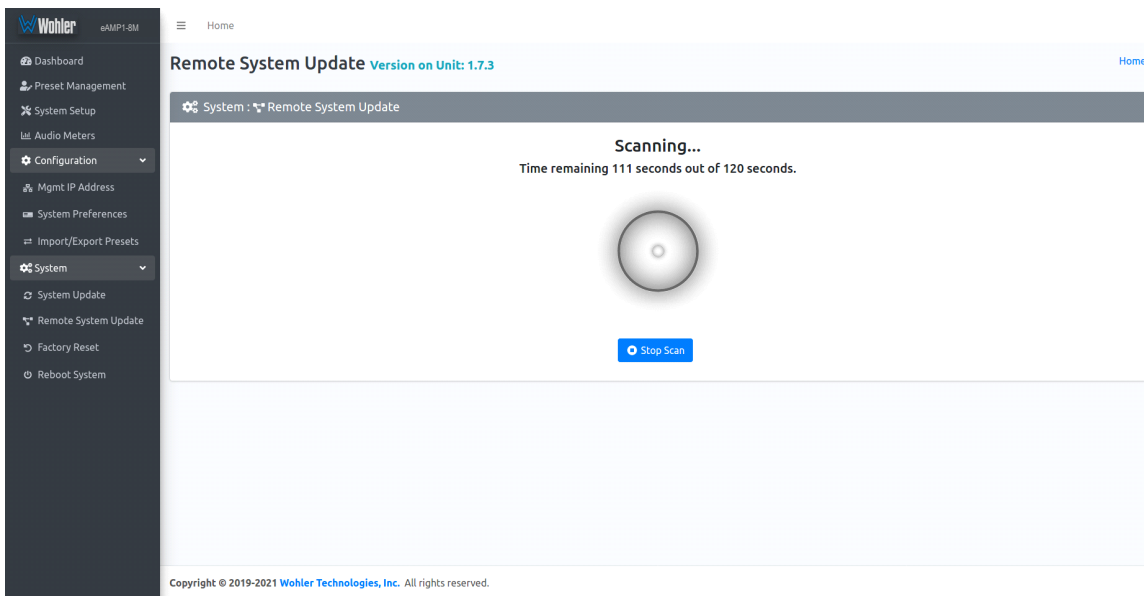

Note: The scanning process will take 2 minutes. Progress is shown on the screen. If for some reason you would like to stop the scan prematurely, click the **Stop Scan** button.

Important: **Do not** run the scanning or updating process from **more than one Master Unit** at a time, to avoid problems. Although you may be updating multiple units at the same time, never attempt this process from more than one **Master Unit**.

3. When the scanning is complete, a list of found eAMP1-8M/16M units will be shown as in Figure A-13. Click either **Select All** or click only the **Target** units that you want to update.

Figure A-13 – List of Found eAMP1-8M/16M Units

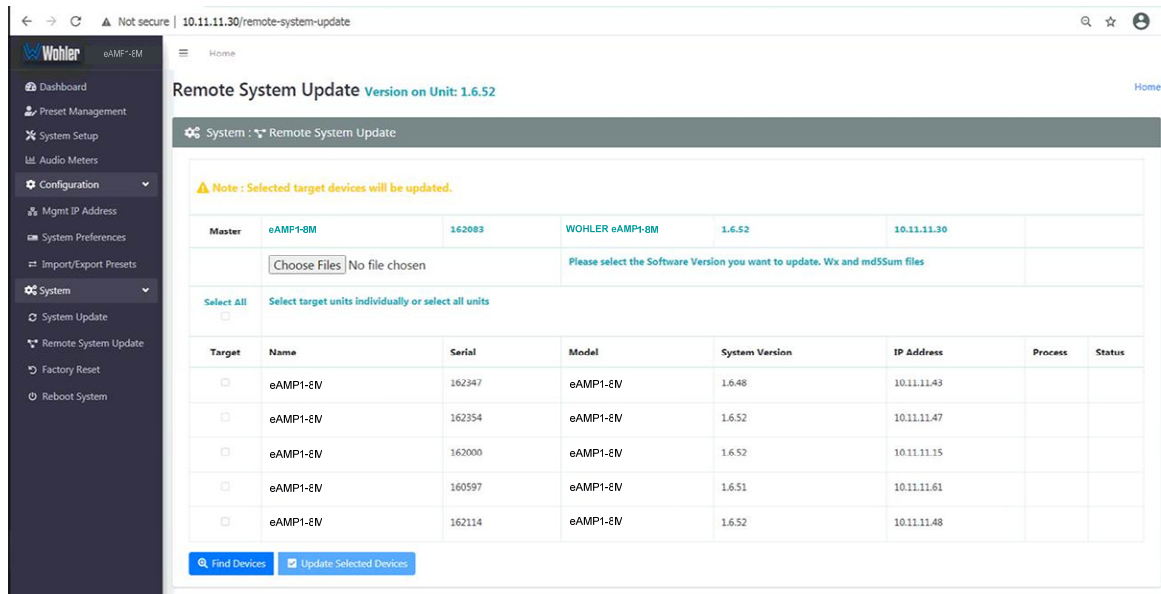

4. Then click **Update Selected Devices**. The window shown in Figure A-14 will appear.

Figure A-14 – Apply System Package

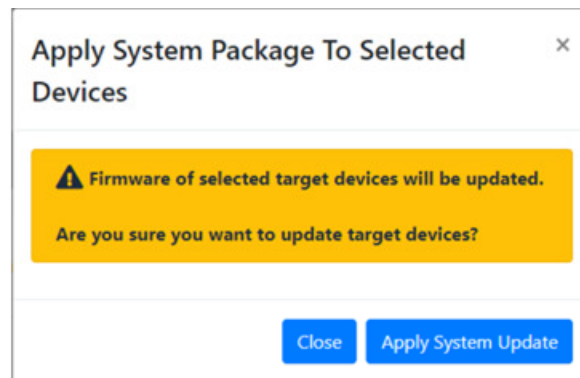

5. Click **Apply System Update**. The screen shown in Figure A-15 will appear. This screen contains a table showing the update progress of each of the eAMP1-8M/16M units being updated.

Figure A-15 – System Update Progress

The screenshot shows the 'Remote System Update' page in the Wohler web interface. The page title is 'Remote System Update Version on Unit: 1.1.14'. A note states: 'Selected target devices will be updated.' Below this, there is a table with columns: Master, Name, Serial, Model, System Version, IP Address, Process, and Status. The table contains one entry for 'eAMP1-8M' with serial '162159' and model 'WOHLER_eAMP1-8M_91940XX'. The system version is '1.1.13' and the IP address is '192.168.0.188'. The status is '■'. There are buttons for 'Find Devices' and 'Update Selected Devices'.

Master	Name	Serial	Model	System Version	IP Address	Process	Status
eAMP1-8M	162978	WOHLER_eAMP1-8M_91940XX	1.14	192.168.0.223			
	Choose Files	Wohler eAMP1-8M version 1.1.14 will be applied		wohler_jvam_1_3_919476_v1.1.14.wx wohler_jvam_1_3_919476_v1.1.14.wx.md5sum			
Select All	Select target units individually or select all units						
	eAMP1-8M	162159	WOHLER_eAMP1-8M_91940XX	1.1.13	192.168.0.188		■

6. At this point, wait for each update to complete. It may take several minutes, but **it is critical not to disturb any of the eAMP1-8M/16M units or the Web GUI** until the update process is complete. When it is complete, each eAMP1-8M/16M will restart.

APPENDIX E: API Documentation

Introduction

If the OPTe Package is purchased, then the Application Program Interface (API) is available for use. This appendix discusses ways to use the API to allow third party equipment to remotely access options and settings of the eAMP1-8M/16M. It includes specific code examples for commonly used requests. The API uses JavaScript Object Notation (JSON) as its communication language.

Follow the instructions in the **First Time IP Assignments** section of Chapter 4 to achieve the required network connection.

API: Presets

1. GET Active Preset

Method: GET

/api/cf/presets/current

Example Response:

```
{
  "serial_number": "",
  "model": "eAMP",
  "version": 1.3,
  "name": "eAMP",
  "result": {
    "group": {
      "Id": 1,
      "Name": ""
    },
    "preset": {
      "Data": null,
      "Favorite": 0,
      "Id": 1,
      "Name": ""
    }
  }
}
```

2. GET Preset Configuration

Method: GET

/api/cf/presets/<int:preset ID>

Example Response:

```
{
  "error": null,
  "params": {
    "PresetId": 1
  },
  "result": {
    "GroupId": 1,
    "PresetName": "SDI",
    "Data": {
      "Name": {
        "Program": "",
        "Group": "G1",
        "Preset": "SDI"
      },
      "VideoSource": {
        "InputNo": 1,
        "ConnectorType": "BNC",
        "Slot": 1,
        "Type": "SDI",
        "Cage": 1
      },
      "DolbyDetection": {
        "NonAudio": "Enabled",
        "PaHeader": "Enabled"
      },
      "Clusters": [
        {
          "NumberOfMeters": 2,
          "FirstMeter": 1,
          "Name": "Stereo 2.0 #1",
          "Type": "Stereo",
          "MuteOnPresetRecall": true
        },
        {
          "NumberOfMeters": 2,
          "FirstMeter": 3,
          "Name": "Stereo 2.0 #2",
          "Type": "Stereo",
          "MuteOnPresetRecall": true
        },
        {
          "NumberOfMeters": 2,
          "FirstMeter": 5,
          "Name": "Stereo 2.0 #3",
          "Type": "Stereo",
          "MuteOnPresetRecall": true
        },
        {
          "NumberOfMeters": 2,
          "FirstMeter": 7,
          "Name": "Stereo 2.0 #4",
          "Type": "Stereo",
          "MuteOnPresetRecall": true
        },
        {
          "NumberOfMeters": 2,
```

```

"FirstMeter": 9,
"Name": "Stereo 2.0 #5",
"Type": "Stereo",
"MuteOnPresetRecall": true
},
{
"NumberOfMeters": 2,
"FirstMeter": 11,
"Name": "Stereo 2.0 #6",
"Type": "Stereo",
"MuteOnPresetRecall": true
},
{
"NumberOfMeters": 2,
"FirstMeter": 13,
"Name": "Stereo 2.0 #7",
"Type": "Stereo",
"MuteOnPresetRecall": true
},
{
"NumberOfMeters": 2,
"FirstMeter": 15,
"Name": "Stereo 2.0 #8",
"Type": "Stereo",
"MuteOnPresetRecall": true
}
],
"MeterSet": {
"13": {
"Source": {
"Slot": 1,
"Cage": 1,
"Channel": 13,
"ConnectorType": "BNC",
"InputNo": 1,
"InputIndex": 0,
"Type": "SDI"
},
"VolumeDb": 0,
"DelayMs": 0,
"Speaker": "Left"
},
"8": {
"Source": {
"Slot": 1,
"Cage": 1,
"Channel": 8,
"ConnectorType": "BNC",
"InputNo": 1,
"InputIndex": 0,
"Type": "SDI"
},
"VolumeDb": 0,
"DelayMs": 0,
"Speaker": "Right"
},
"2": {
"Source": {
"Slot": 1,
"Cage": 1,
"Channel": 2,
"ConnectorType": "BNC",
"InputNo": 1,
"InputIndex": 0,
"Type": "SDI"
},
"VolumeDb": 0,

```

```

"DelayMs": 0,
"Speaker": "Right"
},
"3": {
"Source": {
"Slot": 1,
"Cage": 1,
"Channel": 3,
"ConnectorType": "BNC",
"InputNo": 1,
"InputIndex": 0,
"Type": "SDI"
},
"VolumeDb": 0,
"DelayMs": 0,
"Speaker": "Left"
},
"4": {
"Source": {
"Slot": 1,
"Cage": 1,
"Channel": 4,
"ConnectorType": "BNC",
"InputNo": 1,
"InputIndex": 0,
"Type": "SDI"
},
"VolumeDb": 0,
"DelayMs": 0,
"Speaker": "Right"
},
"16": {
"Source": {
"Slot": 1,
"Cage": 1,
"Channel": 16,
"ConnectorType": "BNC",
"InputNo": 1,
"InputIndex": 0,
"Type": "SDI"
},
"VolumeDb": 0,
"DelayMs": 0,
"Speaker": "Right"
},
"11": {
"Source": {
"Slot": 1,
"Cage": 1,
"Channel": 11,
"ConnectorType": "BNC",
"InputNo": 1,
"InputIndex": 0,
"Type": "SDI"
},
"VolumeDb": 0,
"DelayMs": 0,
"Speaker": "Left"
},
"15": {
"Source": {
"Slot": 1,
"Cage": 1,
"Channel": 15,
"ConnectorType": "BNC",
"InputNo": 1,
"InputIndex": 0,

```

```

    "Type": "SDI"
  },
  "VolumeDb": 0,
  "DelayMs": 0,
  "Speaker": "Left"
},
"5": {
  "Slot": 0,
  "Cage": 0,
  "ConnectorType": "None",
  "Source": {
    "Slot": 1,
    "Cage": 1,
    "Channel": 5,
    "ConnectorType": "BNC",
    "InputNo": 1,
    "InputIndex": 0,
    "Type": "SDI"
  },
  "VolumeDb": 0,
  "DelayMs": 0,
  "Speaker": "Left"
},
"9": {
  "Source": {
    "Slot": 1,
    "Cage": 1,
    "Channel": 9,
    "ConnectorType": "BNC",
    "InputNo": 1,
    "InputIndex": 0,
    "Type": "SDI"
  },
  "VolumeDb": 0,
  "DelayMs": 0,
  "Speaker": "Left"
},
"14": {
  "Source": {
    "Slot": 1,
    "Cage": 1,
    "Channel": 14,
    "ConnectorType": "BNC",
    "InputNo": 1,
    "InputIndex": 0,
    "Type": "SDI"
  },
  "VolumeDb": 0,
  "DelayMs": 0,
  "Speaker": "Right"
},
"6": {
  "Source": {
    "Slot": 1,
    "Cage": 1,
    "Channel": 6,
    "ConnectorType": "BNC",
    "InputNo": 1,
    "InputIndex": 0,
    "Type": "SDI"
  },
  "VolumeDb": 0,
  "DelayMs": 0,
  "Speaker": "Right"
},
"7": {
  "Source": {

```



```

"Slot": 1,
"Cage": 1,
"Channel": 7,
"ConnectorType": "BNC",
"InputNo": 1,
"InputIndex": 0,
"Type": "SDI"
},
"VolumeDb": 0,
"DelayMs": 0,
"Speaker": "Left"
},
"10": {
"Source": {
"Slot": 1,
"Cage": 1,
"Channel": 10,
"ConnectorType": "BNC",
"InputNo": 1,
"InputIndex": 0,
"Type": "SDI"
},
"VolumeDb": 0,
"DelayMs": 0,
"Speaker": "Right"
},
"12": {
"Source": {
"Slot": 1,
"Cage": 1,
"Channel": 12,
"ConnectorType": "BNC",
"InputNo": 1,
"InputIndex": 0,
"Type": "SDI"
},
"VolumeDb": 0,
"DelayMs": 0,
"Speaker": "Right"
},
"1": {
"Source": {
"Slot": 1,
"Cage": 1,
"Channel": 1,
"ConnectorType": "BNC",
"InputNo": 1,
"InputIndex": 0,
"Type": "SDI"
},
"VolumeDb": 0,
"DelayMs": 0,
"Speaker": "Left"
}
},
"SystemClockSource": {
"Slot": 0,
"Cage": 0,
"ConnectorType": "None",
"InputNo": 0,
"Type": "None",
"Pair": 0
}
},
"Favorite": 0,
"PresetId": 1,
"GroupName": "G1"

```

```
}  
}
```

3. GET list of groups/presets

Method: GET

/api/cf/groups

Example Response:

```
{  
  "error": null,  
  "params": null,  
  "result": [  
    {  
      "Name": "G1",  
      "Presets": [  
        {  
          "Favorite": 1,  
          "Name": "AES",  
          "Id": 3  
        },  
        {  
          "Favorite": 0,  
          "Name": "SDI",  
          "Id": 1  
        }  
      ],  
      "Id": 1  
    },  
    {  
      "Name": "AES",  
      "Presets": [  
        {  
          "Favorite": 0,  
          "Name": "dfsdf",  
          "Id": 2  
        }  
      ],  
      "Id": 2  
    }  
  ]  
}
```

4. GET to recall the preset

Method: GET

api/op/presets/<int:presetID>/activate

Example Response:

```
{  
  "error": null,  
  "params": {  
    "PresetId": 1  
  },  
  "result": {  
    "PresetId": 1,  
    "GroupId": 1,  
    "PresetName": "SDI",  
  }  
}
```

```
"GroupName": "G1"
}
}
```

5. POST to delete the group

Method: POST

api/op/group/<int:groupID>/delete

Example Response:

```
{
  "error": null,
  "params": {
    "GroupId": 2
  },
  "result": {
    "GroupId": 2
  }
}
```

6. POST to delete the preset

Method: POST

api/op/preset/<int:presetID>/delete

Example Response:

```
{
  "error": null,
  "params": {
    "PresetId": 4
  },
  "result": {
    "PresetId": 4
  }
}
```

7. POST to rename group

Method: POST

/api/op/group/<int:groupID>/newGrpNameSdi/rename

Example Response:

```
{
  "error": null,
  "params": {
    "GroupId": 1,
    "GroupName": "newGrpNameSdi"
  },
  "result": {
    "GroupId": 1,
    "GroupName": "newGrpNameSdi"
  }
}
```

8. POST to rename preset

Method: POST

/api/op/preset/<int:presetID>/newPresetNameTest/rename

Example Response:

```
{
  "error": null,
  "params": {
    "PresetId": 1,
    "PresetName": "newPresetNameTest"
  },
  "result": {
    "PresetId": 1,
    "PresetName": "newPresetNameTest"
  }
}
```

9. POST to set preset as Favorite

Method: POST

/api/op/preset/<int:presetID>/<favoriteVal>/favorite

Example Response:

```
{
  "error": null,
  "params": {
    "PresetId": 4,
    "Favorite": 1
  },
  "result": {
    "PresetId": 4,
    "Favorite": 1
  }
}
```

10. Source Select

Method: POST

/api/op/sourceselect

1. Body content for Analog

```
{
  "SourceType": "Analog.XLR"
}
```

```
{
```

```
"SourceType": "Analog.DB25"  
}
```

2. **Body content for Aes**

```
{  
  "SourceType": "Aes"  
}
```